

# Open FOAM

*The Open Source CFD Toolbox*

## User Guide

Version 1.6  
24th July 2009

Copyright © 2000, 2001, 2002, 2003, 2004, 2005, 2006, 2007, 2008, 2009 OpenCFD Limited.

Permission is granted to copy, distribute and/or modify this document under the terms of the GNU Free Documentation License, Version 1.2 published by the Free Software Foundation; with no Invariant Sections, no Back-Cover Texts and one Front-Cover Text: “Available free from openfoam.org.” A copy of the license is included in the section entitled “GNU Free Documentation License”.

This document is distributed in the hope that it will be useful, but WITHOUT ANY WARRANTY; without even the implied warranty of MERCHANTABILITY or FITNESS FOR A PARTICULAR PURPOSE.

Typeset in L<sup>A</sup>T<sub>E</sub>X.

---

# GNU Free Documentation License

Version 1.2, November 2002

Copyright ©2000,2001,2002 Free Software Foundation, Inc.

59 Temple Place, Suite 330, Boston, MA 02111-1307 USA

Everyone is permitted to copy and distribute verbatim copies of this license document, but changing it is not allowed.

## Preamble

The purpose of this License is to make a manual, textbook, or other functional and useful document “free” in the sense of freedom: to assure everyone the effective freedom to copy and redistribute it, with or without modifying it, either commercially or noncommercially. Secondly, this License preserves for the author and publisher a way to get credit for their work, while not being considered responsible for modifications made by others.

This License is a kind of “copyleft”, which means that derivative works of the document must themselves be free in the same sense. It complements the GNU General Public License, which is a copyleft license designed for free software.

We have designed this License in order to use it for manuals for free software, because free software needs free documentation: a free program should come with manuals providing the same freedoms that the software does. But this License is not limited to software manuals; it can be used for any textual work, regardless of subject matter or whether it is published as a printed book. We recommend this License principally for works whose purpose is instruction or reference.

## 1. APPLICABILITY AND DEFINITIONS

This License applies to any manual or other work, in any medium, that contains a notice placed by the copyright holder saying it can be distributed under the terms of this License. Such a notice grants a world-wide, royalty-free license, unlimited in duration, to use that work under the conditions stated herein. The “**Document**”, below, refers to any such manual or work. Any member of the public is a licensee, and is addressed as “**you**”. You accept the license if you copy, modify or distribute the work in a way requiring permission under copyright law.

A “**Modified Version**” of the D8(e)-053.1098(e)-437.503(D)8.811(m)0.0828044(e)-~~13~~.233867(n)0653867(

document straightforwardly with generic text editors or (for images composed of pixels) generic paint programs or (for drawings) some widely available drawing editor, and that is suitable for input to text formatters or for automatic translation to a variety of formats suitable for input to text formatters. A copy made in an otherwise Transparent file format whose markup, or absence of markup, has been arranged to thwart or discourage subsequent modification by readers is not Transparent. An image format is not Transparent if used for any substantial amount of text. A copy that is not “Transparent” is called “**Opaque**”.

Examples of suitable formats for Transparent copies include plain ASCII without markup, Texinfo input format, LaTeX input format, SGML or XML using a publicly available DTD, and standard-conforming simple HTML, PostScript or PDF designed for human modification. Examples of transparent image formats include PNG, XCF and JPG. Opaque formats include proprietary formats that can be read and edited only by proprietary word processors, SGML or XML for which the DTD and/or processing tools are not generally available, and the machine-generated HTML, PostScript or PDF produced by some word processors for output purposes only.

The “**Title Page**” means, for a printed book, the title page itself, plus such following pages as are needed to hold, legibly, the material this License requires to appear in the title page. For works in formats which do not have any title page as such, “Title Page” means the text near the most prominent appearance of the work’s title, preceding the beginning of the body of the text.

A section “**Entitled XYZ**” means a named subunit of the Document whose title either is precisely XYZ or contains XYZ in parentheses following text that translates XYZ in another language. (Here XYZ stands for a specific section name mentioned below, such as “**Acknowledgements**”, “**Dedications**”, “**Endorsements**”, or “**History**”.) To “**Preserve the Title**” of such a section when you modify the Document means that it remains a section “Entitled XYZ” according to this definition.

The Document may include Warranty Disclaimers next to the notice which states that this License applies to the Document. These Warranty Disclaimers are considered to be included by reference in this License, but only as regards disclaiming warranties: any other implication that these Warranty Disclaimers may have is void and has no effect on the meaning of this License.

## 2. VERBATIM COPYING

You may copy and distribute the Document in any medium, either commercially or noncommercially, provided that this License, the copyright notices, and the license notice saying this License applies to the Document are reproduced in all copies, and that you add no other conditions whatsoever to those of this License. You may not use technical measures to obstruct or control the reading or further copying of the copies you make or distribute. However, you may accept compensation in exchange for copies. If you distribute a large enough number of copies you must also follow the conditions in section 3.

You may also lend copies, under the same conditions stated above, and you may publicly display copies.

## 3. COPYING IN QUANTITY

If you publish printed copies (or copies in media that commonly have printed covers) of the Document, numbering more than 100, and the Document’s license notice requires Cover Texts, you must enclose the copies in covers that carry, clearly and legibly, all these Cover Texts: Front-Cover Texts on the front cover, and Back-Cover Texts on the back cover. Both covers must also clearly and legibly identify you as the publisher of these copies. The front cover must present the full title with all words of the title equally prominent and visible. You may add other material on the covers in addition. Copying with changes limited to the covers, as long as they preserve the title of the Document and satisfy these conditions, can be treated as verbatim copying in other respects.

If the required texts for either cover are too voluminous to fit legibly, you should put the first ones listed (as many as fit reasonably) on the actual cover, and continue the rest onto adjacent pages.

If you publish or distribute Opaque copies of the Document numbering more than 100, you must either include a machine-readable Transparent copy along with each Opaque copy, or state in or with each Opaque copy a computer-network location from which the general network-using public has access to download using public-standard network protocols a complete Transparent copy of the Document, free of added material. If you use the latter option, you must take reasonably prudent steps, when you begin distribution of Opaque copies in quantity, to ensure that this Transparent copy will remain thus accessible at the stated location until at least one year after the last time you distribute an Opaque copy (directly or through your agents or retailers) of that edition to the public.

It is requested, but not required, that you contact the authors of the Document well before redistributing any large number of copies, to give them a chance to provide you with an updated version of the Document.

#### 4. MODIFICATIONS

You may copy and distribute a Modified Version of the Document under the conditions of sections 2 and 3 above, provided that you release the Modified Version under precisely this License, with the Modified Version filling the role of the Document, thus licensing distribution and modification of the Modified Version to whoever possesses a copy of it. In addition, you must do these things in the Modified Version:

- A. Use in the Title Page (and on the covers, if any) a title distinct from that of the Document, and from those of previous versions (which should, if there were any, be listed in the History section of the Document). You may use the same title as a previous version if the original publisher of that version gives permission.
- B. List on the Title Page, as authors, one or more persons or entities responsible for authorship of the modifications in the Modified Version, together with at least five of the principal authors of the Document (all of its principal authors, if it has fewer than five), unless they release you from this requirement.
- C. State on the Title page the name of the publisher of the Modified Version, as the publisher.
- D. Preserve all the copyright notices of the Document.
- E. Add an appropriate copyright notice for your modifications adjacent to the other copyright notices.
- F. Include, immediately after the copyright notices, a license notice giving the public permission to use the Modified Version under the terms of this License, in the form shown in the Addendum below.
- G. Preserve in that license notice the full lists of Invariant Sections and required Cover Texts given in the Document's license notice.
- H. Include an unaltered copy of this License.
- I. Preserve the section Entitled "History", Preserve its Title, and add to it an item stating at least the title, year, new authors, and publisher of the Modified Version as given on the Title Page. If there is no section Entitled "History" in the Document, create one stating the title, year, authors, and publisher of the Document as given on its Title Page, then add an item describing the Modified Version as stated in the previous sentence.

- J. Preserve the network location, if any, given in the Document for public access to a Transparent copy of the Document, and likewise the network locations given in the Document for previous versions it was based on. These may be placed in the “History” section. You may omit a network location for a work that was published at least four years before the Document itself, or if the original publisher of the version it refers to gives permission.
- K. For any section Entitled “Acknowledgements” or “Dedications”, Preserve the Title of the section, and preserve in the section all the substance and tone of each of the contributor acknowledgements and/or dedications given therein.
- L. Preserve all the Invariant Sections of the Document, unaltered in their text and in their titles. Section numbers or the equivalent are not considered part of the section titles.
- M. Delete any section Entitled “Endorsements”. Such a section may not be included in the Modified Version.
- N. Do not retitle any existing section to be Entitled “Endorsements” or to conflict in title with any Invariant Section.
- O. Preserve any Warranty Disclaimers.

If the Modified Version includes new front-matter sections or appendices that qualify as Secondary Sections and contain no material copied from the Document, you may at your option designate some or all of these sections as invariant. To do this, add their titles to the list of Invariant Sections in the Modified Version’s license notice. These titles must be distinct from any other section titles.

You may add a section Entitled “Endorsements”, provided it contains nothing but endorsements of your Modified Version by various parties—for example, statements of peer review or that the text has been approved by an organization as the authoritative definition of a standard.

You may add a passage of up to five words as a Front-Cover Text, and a passage of up to 25 words as a Back-Cover Text, to the end of the list of Cover Texts in the Modified Version. Only one passage of Front-Cover Text and one of Back-Cover Text may be added by (or through arrangements made by) any one entity. If the Document already includes a cover text for the same cover, previously added by you or by arrangement made by the same entity you are acting on behalf of, you may not add another; but you may replace the old one, on explicit permission from the previous publisher that added the old one.

The author(s) and publisher(s) of the Document do not by this License give permission to use their names for publicity for or to assert or imply endorsement of any Modified Version.

## 5. COMBINING DOCUMENTS

You may combine the Document with other documents released under this License, under the terms defined in section 4 above for modified versions, provided that you include in the combination all of the Invariant Sections of all of the original documents, unmodified, and list them all as Invariant Sections of your combined work in its license notice, and that you preserve all their Warranty Disclaimers.

The combined work need only contain one copy of this License, and multiple identical Invariant Sections may be replaced with a single copy. If there are multiple Invariant Sections with the same name but different contents, make the title of each such section unique by adding at the end of it, in parentheses, the name of the original author.

Invariant Sections in the license notice of the combined work

---

## 6. COLLECTIONS OF DOCUMENTS

You may make a collection consisting of the Document and other documents released under this License, and replace the individual copies of this License in the various documents with a single copy that is included in the collection, provided that you follow the rules of this License for verbatim copying of each of the documents in all other respects.

You may extract a single document from such a collection, and distribute it individually under this License, provided you insert a copy of this License into the extracted document, and follow this License in all other respects regarding verbatim copying of that document.

## 7. AGGREGATION WITH INDEPENDENT WORKS

A compilation of the Document or its derivatives with other separate and independent documents or works, in or on a volume of a storage or distribution medium, is called an “aggregate” if the copyright resulting from the compilation is not used to limit the legal rights of the compilation’s users beyond what the individual works permit. When the Document is included in an aggregate, this License does not apply to the other works in the aggregate which are not themselves derivative works of the Document.

If the Cover Text requirement of section 3 is applicable to these copies of the Document, then if the Document is less than one half of the entire aggregate, the Document’s Cover Texts may be placed on covers that bracket the Document within the aggregate, or the electronic equivalent of covers if the Document is in electronic form. Otherwise they must appear on printed covers that bracket the whole aggregate.

## 8. TRANSLATION

Translation is considered a kind of modification, so you may distribute translations of the Document under the terms of section 4. Replacing Invariant Sections with translations requires special permission from their copyright holders, but you may include translations of some or all Invariant Sections in addition to the original versions of these Invariant Sections. You may include a translation of this License, and all the license notices in the Document, and any Warranty Disclaimers, provided that you also include the original English version of this License and the original versions of those notices and disclaimers. In case of a disagreement between the translation and the original version of this License or a notice or disclaimer, the original version will prevail.

If a section in the Document is Entitled “Acknowledgements”, “Dedications”, or “History”, the requirement (section 4) to Preserve its Title (section 1) will typically require changing the actual title.

## 9. TERMINATION

You may not copy, modify, sublicense, or distribute the Document except as expressly provided for under this License. Any other attempt to copy, modify, sublicense or distribute the Document is void, and will automatically terminate your rights under this License. However, parties who have received copies, or rights, from you under this License will not have their licenses terminated so long as such parties remain in full compliance.

## 10. FUTURE REVISIONS OF THIS LICENSE

The Free Software Foundation may publish new, revised versions of the GNU Free Documentation License from time to time. Such new versions will be similar in spirit to the present version, but may differ in detail to address new problems or concerns. See <http://www.gnu.org/copyleft/>.

Each version of the License is given a distinguishing version number. If the Document specifies that a particular numbered version of this License “or any later version” applies to it, you have the option of following the terms and conditions either of that specified version or of

any later version that has been published (not as a draft) by the Free Software Foundation. If the Document does not specify a version number of this License, you may choose any version ever published (not as a draft) by the Free Software Foundation.



## Trademarks

ANSYS is a registered trademark of ANSYS Inc.

CFX is a registered trademark of Ansys Inc.

CHEMKIN is a registered trademark of Reaction Design Corporation

EnSight is a registered trademark of Computational Engineering International Ltd.

Fieldview is a registered trademark of Intelligent Light

Fluent is a registered trademark of Ansys Inc.

GAMBIT is a registered trademark of Ansys Inc.

Icem-CFD is a registered trademark of Ansys Inc.

I-DEAS is a registered trademark of Structural Dynamics Research Corporation

JAVA is a registered trademark of Sun Microsystems Inc.

Linux is a registered trademark of Linus Torvalds

OpenFOAM is a registered trademark of OpenCFD Ltd

ParaView is a registered trademark of Kitware

STAR-CD is a registered trademark of Computational Dynamics Ltd.

UNIX is a registered trademark of The Open Group



# Contents

<b>Copyright Notice</b>	<b>U-2</b>
<b>GNU Free Documentation Licence</b>	<b>U-3</b>
1. APPLICABILITY AND DEFINITIONS . . . . .	U-3
2. VERBATIM COPYING . . . . .	U-4
3. COPYING IN QUANTITY . . . . .	U-4
4. MODIFICATIONS . . . . .	U-5
5. COMBINING DOCUMENTS . . . . .	U-6
6. COLLECTIONS OF DOCUMENTS . . . . .	U-7
7. AGGREGATION WITH INDEPENDENT WORKS . . . . .	U-7
8. TRANSLATION . . . . .	U-7
9. TERMINATION . . . . .	U-7
10. FUTURE REVISIONS OF THIS LICENSE . . . . .	U-7
<b>Trademarks</b>	<b>U-9</b>
<b>Contents</b>	<b>U-11</b>
<b>1 Introduction</b>	<b>U-17</b>
<b>2 Tutorials</b>	<b>U-19</b>
2.1 Lid-driven cavity flow . . . . .	U-19
2.1.1 Pre-processing . . . . .	U-20
2.1.1.1 Mesh generation . . . . .	U-20
2.1.1.2 Boundary and initial conditions . . . . .	U-22
2.1.1.3 Physical properties . . . . .	U-23
2.1.1.4 Control . . . . .	U-23
2.1.1.5 Discretisation and linear-solver settings . . . . .	U-25
2.1.2 Viewing the mesh . . . . .	U-25
2.1.3 Running an application . . . . .	U-26
2.1.4 Post-processing . . . . .	U-28
2.1.4.1 Isosurface and contour plots . . . . .	U-28
2.1.4.2 Vector plots . . . . .	U-30
2.1.4.3 Streamline plots . . . . .	U-30
2.1.5 Increasing the mesh resolution . . . . .	U-30
2.1.5.1 Creating a new case using an existing case . . . . .	U-32
2.1.5.2 Creating the finer mesh . . . . .	U-32
2.1.5.3 Mapping the coarse mesh results onto the fine mesh . . . . .	U-32
2.1.5.4 Control adjustments . . . . .	U-33
2.1.5.5 Running the code as a background process . . . . .	U-33
2.1.5.6 Vector plot with the refined mesh . . . . .	U-33

2.1.5.7	Plotting graphs . . . . .	U-34
2.1.6	Introducing mesh grading . . . . .	U-36
2.1.6.1	Creating the graded mesh . . . . .	U-37
2.1.6.2	Changing time and time step . . . . .	U-38
2.1.6.3	Mapping fields . . . . .	U-39
2.1.7	Increasing the Reynolds number . . . . .	U-39
2.1.7.1	Pre-processing . . . . .	U-39
2.1.7.2	Running the code . . . . .	U-39
2.1.8	High Reynolds number flow . . . . .	U-40
2.1.8.1	Pre-processing . . . . .	U-41
2.1.8.2	Running the code . . . . .	U-42
2.1.9	Changing the case geometry . . . . .	U-43
2.1.10	Post-processing the modified geometry . . . . .	U-46
2.2	Stress analysis of a plate with a hole . . . . .	U-46
2.2.1	Mesh generation . . . . .	U-47
2.2.1.1	Boundary and initial conditions . . . . .	U-49
2.2.1.2	Mechanical properties . . . . .	U-51
2.2.1.3	Thermal properties . . . . .	U-51
2.2.1.4	Control . . . . .	U-51
2.2.1.5	Discretisation schemes and linear-solver control . . . . .	U-52
2.2.2	Running the code . . . . .	U-54
2.2.3	Post-processing . . . . .	U-54
2.2.4	Exercises . . . . .	U-55
2.2.4.1	Increasing mesh resolution . . . . .	U-55
2.2.4.2	Introducing mesh grading . . . . .	U-56
2.2.4.3	Changing the plate size . . . . .	U-56
2.3	Breaking of a dam . . . . .	U-56
2.3.1	Mesh generation . . . . .	U-56
2.3.2	Boundary conditions . . . . .	U-58
2.3.3	Setting initial field . . . . .	U-58
2.3.4	Fluid properties . . . . .	U-59
2.3.5	Turbulence modelling . . . . .	U-60
2.3.6	Time step control . . . . .	U-60
2.3.7	Discretisation schemes . . . . .	U-61
2.3.8	Linear-solver control . . . . .	U-62
2.3.9	Running the code . . . . .	U-62
2.3.10	Post-processing . . . . .	U-63
2.3.11	Running in parallel . . . . .	U-63
2.3.12	Post-processing a case run in parallel . . . . .	U-67
<b>3</b>	<b>Applications and libraries</b> . . . . .	<b>U-69</b>
3.1	The programming language of OpenFOAM . . . . .	U-69
3.1.1	Language in general . . . . .	U-69
3.1.2	Object-orientation and C++ . . . . .	U-70
3.1.3	Equation representation . . . . .	U-70
3.1.4	Solver codes . . . . .	U-71
3.2	Compiling applications and libraries . . . . .	U-71
3.2.1	Header <i>.H</i> files . . . . .	U-71
3.2.2	Compiling with <i>wmake</i> . . . . .	U-73
3.2.2.1	Including headers . . . . .	U-73
3.2.2.2	Linking to libraries . . . . .	U-74

3.2.2.3	Source files to be compiled . . . . .	U-74
3.2.2.4	Running <code>wmake</code> . . . . .	U-75
3.2.2.5	<code>wmake</code> environment variables . . . . .	U-75
3.2.3	Removing dependency lists: <code>wclean</code> and <code>rmdepall</code> . . . . .	U-75
3.2.4	Compilation example: the <code>isoFoam</code> application . . . . .	U-76
3.2.5	Debug messaging and optimisation switches . . . . .	U-79
3.2.6	Linking new user-defined libraries to existing applications . . . . .	U-80
3.3	Running applications . . . . .	U-80
3.4	Running applications in parallel . . . . .	U-81
3.4.1	Decomposition of mesh and initial field data . . . . .	U-81
3.4.2	Running a decomposed case . . . . .	U-83
3.4.3	Distributing data across several disks . . . . .	U-84
3.4.4	Post-processing parallel processed cases . . . . .	U-85
3.4.4.1	Reconstructing mesh and data . . . . .	U-85
3.4.4.2	Post-processing decomposed cases . . . . .	U-85
3.5	Standard solvers . . . . .	U-85
3.6	Standard utilities . . . . .	U-88
3.7	Standard libraries . . . . .	U-94
<b>4</b>	<b>OpenFOAM cases</b> . . . . .	<b>U-101</b>
4.1	File structure of OpenFOAM cases . . . . .	U-101
4.2	Basic input/output file format . . . . .	U-102
4.2.1	General syntax rules . . . . .	U-102
4.2.2	Dictionaries . . . . .	U-102
4.2.3	The data file header . . . . .	U-103
4.2.4	Lists . . . . .	U-104
4.2.5	Scalars, vectors and tensors . . . . .	U-105
4.2.6	Dimensional units . . . . .	U-105
4.2.7	Dimensioned types . . . . .	U-106
4.2.8	Fields . . . . .	U-106
4.2.9	Directives and macro substitutions . . . . .	U-107
4.3	Time and data input/output control . . . . .	U-108
4.4	Numerical schemes . . . . .	U-110
4.4.1	Interpolation schemes . . . . .	U-112
4.4.1.1	Schemes for strictly bounded scalar fields . . . . .	U-113
4.4.1.2	Schemes for vector fields . . . . .	U-113
4.4.2	Surface normal gradient schemes . . . . .	U-114
4.4.3	Gradient schemes . . . . .	U-114
4.4.4	Laplacian schemes . . . . .	U-115
4.4.5	Divergence schemes . . . . .	U-115
4.4.6	Time schemes . . . . .	U-116
4.4.7	Flux calculation . . . . .	U-117
4.5	Solution and algorithm control . . . . .	U-117
4.5.1	Linear solver control . . . . .	U-117
4.5.1.1	Solution tolerances . . . . .	U-118
4.5.1.2	Preconditioned conjugate gradient solvers . . . . .	U-119
4.5.1.3	Smooth solvers . . . . .	U-119
4.5.1.4	Geometric-algebraic multi-grid solvers . . . . .	U-119
4.5.2	Solution under-relaxation . . . . .	U-120
4.5.3	PISO and SIMPLE algorithms . . . . .	U-121
4.5.3.1	Pressure referencing . . . . .	U-121

4.5.4	Other parameters . . . . .	U-122
<b>5</b>	<b>Mesh generation and conversion</b>	<b>U-123</b>
5.1	Mesh description . . . . .	U-123
5.1.1	Mesh specification and validity constraints . . . . .	U-123
5.1.1.1	Points . . . . .	U-124
5.1.1.2	Faces . . . . .	U-124
5.1.1.3	Cells . . . . .	U-124
5.1.1.4	Boundary . . . . .	U-125
5.1.2	The <code>polyMesh</code> description . . . . .	U-125
5.1.3	The <code>cellShape</code> tools . . . . .	U-126
5.1.4	1- and 2-dimensional and axi-symmetric problems . . . . .	U-126
5.2	Boundaries . . . . .	U-128
5.2.1	Specification of patch types in OpenFOAM . . . . .	U-128
5.2.2	Base types . . . . .	U-130
5.2.3	Primitive types . . . . .	U-132
5.2.4	Derived types . . . . .	U-132
5.3	Mesh generation with the <code>blockMesh</code> utility . . . . .	U-132
5.3.1	Writing a <code>blockMeshDict</code> file . . . . .	U-134
5.3.1.1	The <code>vertices</code> . . . . .	U-135
5.3.1.2	The <code>edges</code> . . . . .	U-135
5.3.1.3	The <code>blocks</code> . . . . .	U-136
5.3.1.4	The <code>patches</code> . . . . .	U-137
5.3.2	Multiple blocks . . . . .	U-138
5.3.3	Creating blocks with fewer than 8 vertices . . . . .	U-139
5.3.4	Running <code>blockMesh</code> . . . . .	U-140
5.4	Mesh generation with the <code>snappyHexMesh</code> utility . . . . .	U-140
5.4.1	The mesh generation process of <code>snappyHexMesh</code> . . . . .	U-141
5.4.2	Creating the background hex mesh . . . . .	U-142
5.4.3	Cell splitting at feature edges and surfaces . . . . .	U-143
5.4.4	Cell removal . . . . .	U-144
5.4.5	Cell splitting in specified regions . . . . .	U-145
5.4.6	Snapping to surfaces . . . . .	U-146
5.4.7	Mesh layers . . . . .	U-146
5.4.8	Mesh quality controls . . . . .	U-148
5.5	Mesh conversion . . . . .	U-148
5.5.1	<code>fluentMeshToFoam</code> . . . . .	U-149
5.5.2	<code>starToFoam</code> . . . . .	U-150
5.5.2.1	General advice on conversion . . . . .	U-151
5.5.2.2	Eliminating extraneous data . . . . .	U-151
5.5.2.3	Removing default boundary conditions . . . . .	U-152
5.5.2.4	Renumbering the model . . . . .	U-152
5.5.2.5	Writing out the mesh data . . . . .	U-153
5.5.2.6	Problems with the <code>.vrt</code> file . . . . .	U-154
5.5.2.7	Converting the mesh to OpenFOAM format . . . . .	U-154
5.5.3	<code>gambitToFoam</code> . . . . .	U-154
5.5.4	<code>ideasToFoam</code> . . . . .	U-155
5.5.5	<code>cfx4ToFoam</code> . . . . .	U-155
5.6	Mapping fields between different geometries . . . . .	U-155
5.6.1	Mapping consistent fields . . . . .	U-156
5.6.2	Mapping inconsistent fields . . . . .	U-156

5.6.3	Mapping parallel cases . . . . .	U-156
<b>6</b>	<b>Post-processing</b>	<b>U-159</b>
6.1	paraFoam . . . . .	U-159
6.1.1	Overview of paraFoam . . . . .	U-159
6.1.2	The Properties panel . . . . .	U-160
6.1.3	The Display panel . . . . .	U-161
6.1.4	The button toolbars . . . . .	U-163
6.1.5	Manipulating the view . . . . .	U-163
6.1.5.1	View settings . . . . .	U-163
6.1.5.2	General settings . . . . .	U-163
6.1.6	Contour plots . . . . .	U-164
6.1.6.1	Introducing a cutting plane . . . . .	U-164
6.1.7	Vector plots . . . . .	U-164
6.1.7.1	Plotting at cell centres . . . . .	U-164
6.1.8	Streamlines . . . . .	U-164
6.1.9	Image output . . . . .	U-165
6.1.10	Animation output . . . . .	U-165
6.2	Post-processing with Fluent . . . . .	U-166
6.3	Post-processing with Fieldview . . . . .	U-167
6.4	Post-processing with EnSight . . . . .	U-167
6.4.1	Converting data to EnSight format . . . . .	U-168
6.4.2	The ensight74FoamExec reader module . . . . .	U-168
6.4.2.1	Configuration of EnSight for the reader module . . . . .	U-168
6.4.2.2	Using the reader module . . . . .	U-168
6.5	Sampling data . . . . .	U-169
6.6	Monitoring and managing jobs . . . . .	U-172
6.6.1	The foamJob script for running jobs . . . . .	U-173
6.6.2	The foamLog script for monitoring jobs . . . . .	U-173
<b>7</b>	<b>Models and physical properties</b>	<b>U-175</b>
7.1	Thermophysical models . . . . .	U-175
7.1.1	Thermophysical property data . . . . .	U-177
7.2	Turbulence models . . . . .	U-178
7.2.1	Model coefficients . . . . .	U-179
7.2.2	Wall functions . . . . .	U-179
<b>Index</b>		<b>U-181</b>





# Chapter 1

## Introduction

This guide accompanies the release of version 1.6 of the Open Source Field Operation and Manipulation (OpenFOAM) C++ libraries. It provides a description of the basic operation of OpenFOAM, first through a set of tutorial exercises in [chapter 2](#) and later by a more detailed description of the individual components that make up OpenFOAM.

OpenFOAM is first and foremost a *C++ library*, used primarily to create executables, known as *applications*. The applications fall into two categories: *solvers*, that are each designed to solve a specific problem in continuum mechanics; and *utilities*, that are designed to perform tasks that involve data manipulation. The OpenFOAM distribution contains numerous solvers and utilities covering a wide range of problems, as described in [chapter 3](#).

One of the strengths of OpenFOAM is that new solvers and utilities can be created by its users with some pre-requisite knowledge of the underlying method, physics and programming techniques involved.

OpenFOAM is supplied with pre- and post-processing environments. The interface to the pre- and post-processing are themselves OpenFOAM utilities, thereby ensuring consistent data handling across all environments. The overall structure of OpenFOAM is shown in [Figure 1.1](#). The pre-processing and running of OpenFOAM cases is described

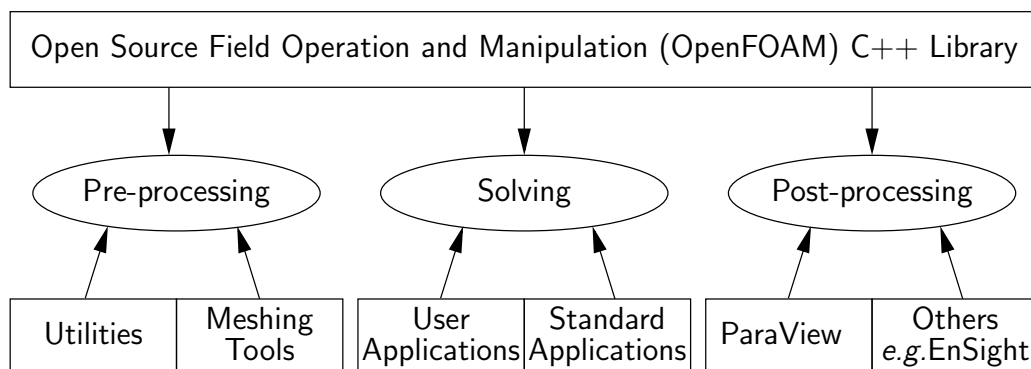

Figure 1.1: Overview of OpenFOAM structure.

in [chapter 4](#) In [chapter 5](#), we cover both the generation of meshes using the mesh generator supplied with OpenFOAM and conversion of mesh data generated by third-party products. Post-processing is described in [chapter 6](#).



# Chapter 2

## Tutorials

In this chapter we shall describe in detail the process of setup, simulation and post-processing for some OpenFOAM test cases, with the principal aim of introducing a user to the basic procedures of running OpenFOAM. The `$FOAM_TUTORIALS` directory contains many more cases that demonstrate the use of all the solvers and many utilities supplied with OpenFOAM. Before attempting to run the tutorials, the user must first make sure that they have installed OpenFOAM correctly.

The tutorial cases describe the use of the `blockMesh` pre-processing tool, case setup and running OpenFOAM solvers and post-processing using `paraFoam`. Those users with access to third-party post-processing tools supported in OpenFOAM have an option: either they can follow the tutorials using `paraFoam`; or refer to the description of the use of the third-party product in [chapter 6](#) when post-processing is required.

Copies of all tutorials are available from the `tutorials` directory of the OpenFOAM installation. The tutorials are organised into a set of directories according to the type of flow and then subdirectories according to solver. For example, all the `icoFoam` cases are stored within a subdirectory `incompressible/icoFoam`, where *incompressible* indicates the type of flow. If the user wishes to run a range of example cases, it is recommended that the user copy the `tutorials` directory into their local `run` directory. They can be easily copied by typing:

```
mkdir -p $FOAM_RUN
cp -r $FOAM_TUTORIALS $FOAM_RUN
```

### 2.1 Lid-driven cavity flow

This tutorial will describe how to pre-process, run and post-process a case involving isothermal, incompressible flow in a two-dimensional square domain. The geometry is shown in [Figure 2.1](#) in which all the boundaries of the square are walls. The top wall moves in the  $x$ -direction at a speed of 1 m/s while the other 3 are stationary. Initially, the flow will be assumed laminar and will be solved on a uniform mesh using the `icoFoam` solver for laminar, isothermal, incompressible flow. During the course of the tutorial, the effect of increased mesh resolution and mesh grading towards the walls will be investigated. Finally, the flow Reynolds number will be increased and the  `pisoFoam`  solver will be used for turbulent, isothermal, incompressible flow.



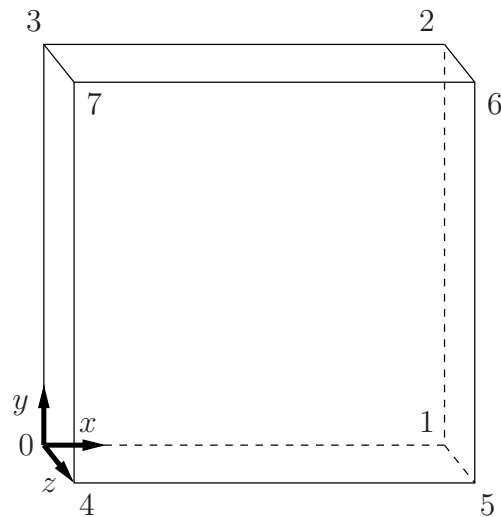

Figure 2.2: Block structure of the mesh for the cavity.

```

11     format      ascii;
12     class       dictionary;
13     object      blockMeshDict;
14 }
15 // * * * * * //
16
17 convertToMeters 0.1;
18
19 vertices
20 (
21     (0 0 0)
22     (1 0 0)
23     (1 1 0)
24     (0 1 0)
25     (0 0 0.1)
26     (1 0 0.1)
27     (1 1 0.1)
28     (0 1 0.1)
29 );
30
31 blocks
32 (
33     hex (0 1 2 3 4 5 6 7) (20 20 1) simpleGrading (1 1 1)
34 );
35
36 edges
37 (
38 );
39
40 patches
41 (
42     wall movingWall
43     (
44         (3 7 6 2)
45     )
46     wall fixedWalls
47     (
48         (0 4 7 3)
49         (2 6 5 1)
50         (1 5 4 0)
51     )
52     empty frontAndBack
53     (
54         (0 3 2 1)
55         (4 5 6 7)
56     )
57 );
58
59 mergePatchPairs
60 (
61 );
62
63 // * * * * * //

```

The file first contains header information in the form of a banner (lines 1-7), then file information contained in a *FoamFile* sub-dictionary, delimited by curly braces (`{...}`).

For the remainder of the manual:

For the sake of clarity and to save space, file headers, including the banner and *FoamFile* sub-dictionary, will be removed from verbatim quoting of case files

The file first specifies coordinates of the block **vertices**; it then defines the **blocks** (here, only 1) from the vertex labels and the number of cells within it; and finally, it defines the boundary patches. The user is encouraged to consult [section 5.3](#) to understand the meaning of the entries in the *blockMeshDict* file.

The mesh is generated by running **blockMesh** on this *blockMeshDict* file. From within the case directory, this is done, simply by typing in the terminal:

```
blockMesh
```

The running status of **blockMesh** is reported in the terminal window. Any mistakes in the *blockMeshDict* file are picked up by **blockMesh** and the resulting error message directs the user to the line in the file where the problem occurred. There should be no error messages at this stage.

### 2.1.1.2 Boundary and initial conditions

Once the mesh generation is complete, the user can look at this initial fields set up for this case. The case is set up to start at time  $t = 0$  s, so the initial field data is stored in a *0* sub-directory of the *cavity* directory. The *0* sub-directory contains 2 files, *p* and *U*, one for each of the pressure (*p*) and velocity (**U**) fields whose initial values and boundary conditions must be set. Let us examine file *p*:

```

17  dimensions      [0 2 -2 0 0 0 0];
18
19  internalField   uniform 0;
20
21  boundaryField
22  {
23      movingWall
24      {
25          type          zeroGradient;
26      }
27
28      fixedWalls
29      {
30          type          zeroGradient;
31      }
32
33      frontAndBack
34      {
35          type          empty;
36      }
37  }
38
39  // ***** //
```

There are 3 principal entries in field data files:

**dimensions** specifies the dimensions of the field, here *kinematic* pressure, *i.e.*  $\text{m}^2 \text{s}^{-2}$  (see [section 4.2.6](#) for more information);

**internalField** the internal field data which can be **uniform**, described by a single value; or **nonuniform**, where all the values of the field must be specified (see [section 4.2.8](#) for more information);

**boundaryField** the boundary field data that includes boundary conditions and data for all the boundary patches (see [section 4.2.8](#) for more information).

For this case `cavity`, the boundary consists of walls only, split into 2 patches named: (1) `fixedWalls` for the fixed sides and base of the cavity; (2) `movingWall` for the moving top of the cavity. As walls, both are given a `zeroGradient` boundary condition for `p`, meaning “the normal gradient of pressure is zero”. The `frontAndBack` patch represents the front and back planes of the 2D case and therefore must be set as `empty`.

In this case, as in most we encounter, the initial fields are set to be uniform. Here the pressure is kinematic, and as an incompressible case, its absolute value is not relevant, so is set to `uniform 0` for convenience.

The user can similarly examine the velocity field in the `0/U` file. The `dimensions` are those expected for velocity, the internal field is initialised as uniform zero, which in the case of velocity must be expressed by 3 vector components, *i.e.* `uniform (0 0 0)` (see [section 4.2.5](#) for more information).

The boundary field for velocity requires the same boundary condition for the `frontAndBack` patch. The other patches are walls: a no-slip condition is assumed on the `fixedWalls`, hence a `fixedValue` condition with a `value` of `uniform (0 0 0)`. The top surface moves at a speed of 1 m/s in the  $x$ -direction so requires a `fixedValue` condition also but with `uniform (1 0 0)`.

### 2.1.1.3 Physical properties

The physical properties for the case are stored in dictionaries whose names are given the suffix `...Properties`, located in the `Dictionaries` directory tree. For an `icoFoam` case, the only property that must be specified is the kinematic viscosity which is stored from the `transportProperties` dictionary. The user can check that the kinematic viscosity is set correctly by opening the `transportProperties` dictionary to view/edit its entries. The keyword for kinematic viscosity is `nu`, the phonetic label for the Greek symbol  $\nu$  by which it is represented in equations. Initially this case will be run with a Reynolds number of 10, where the Reynolds number is defined as:

$$Re = \frac{d|\mathbf{U}|}{\nu} \quad (2.1)$$

where  $d$  and  $|\mathbf{U}|$  are the characteristic length and velocity respectively and  $\nu$  is the kinematic viscosity. Here  $d = 0.1$  m,  $|\mathbf{U}| = 1$  m s<sup>-1</sup>, so that for  $Re = 10$ ,  $\nu = 0.01$  m<sup>2</sup> s<sup>-1</sup>. The correct file entry for kinematic viscosity is thus specified below:

```

17
18  nu                nu [ 0 2 -1 0 0 0 0 ] 0.01;
19
20
21 // ***** //
```

### 2.1.1.4 Control

Input data relating to the control of time and reading and writing of the solution data are read in from the `controlDict` dictionary. The user should view this file; as a case control file, it is located in the `system` directory.

The start/stop times and the time step for the run must be set. OpenFOAM offers great flexibility with time control which is described in full in [section 4.3](#). In this tutorial we wish to start the run at time  $t = 0$  which means that OpenFOAM needs to read field data from a directory named `0` — see [section 4.1](#) for more information of the case file structure. Therefore we set the `startFrom` keyword to `startTime` and then specify the `startTime` keyword to be 0.

For the end time, we wish to reach the steady state solution where the flow is circulating around the cavity. As a general rule, the fluid should pass through the domain 10

times to reach steady state in laminar flow. In this case the flow does not pass through this domain as there is no inlet or outlet, so instead the end time can be set to the time taken for the lid to travel ten times across the cavity, *i.e.* 1 s; in fact, with hindsight, we discover that 0.5 s is sufficient so we shall adopt this value. To specify this end time, we must specify the `stopAt` keyword as `endTime` and then set the `endTime` keyword to 0.5.

Now we need to set the time step, represented by the keyword `deltaT`. To achieve temporal accuracy and numerical stability when running `icoFoam`, a Courant number of less than 1 is required. The Courant number is defined for one cell as:

$$Co = \frac{\delta t |\mathbf{U}|}{\delta x} \quad (2.2)$$

where  $\delta t$  is the time step,  $|\mathbf{U}|$  is the magnitude of the velocity through that cell and  $\delta x$  is the cell size in the direction of the velocity. The flow velocity varies across the domain and we must ensure  $Co < 1$  everywhere. We therefore choose  $\delta t$  based on the worst case: the *maximum*  $Co$  corresponding to the combined effect of a large flow velocity and small cell size. Here, the cell size is fixed across the domain so the maximum  $Co$  will occur next to the lid where the velocity approaches  $1 \text{ m s}^{-1}$ . The cell size is:

$$\delta x = \frac{d}{n} = \frac{0.1}{20} = 0.005 \text{ m} \quad (2.3)$$

Therefore to achieve a Courant number less than or equal to 1 throughout the domain the time step `deltaT` must be set to less than or equal to:

$$\delta t = \frac{Co \delta x}{|\mathbf{U}|} = \frac{1 \times 0.005}{1} = 0.005 \text{ s} \quad (2.4)$$

As the simulation progresses we wish to write results at certain intervals of time that we can later view with a post-processing package. The `writeControl` keyword presents several options for setting the time at which the results are written; here we select the `timeStep` option which specifies that results are written every  $n$ th time step where the value  $n$  is specified under the `writeInterval` keyword. Let us decide that we wish to write our results at times 0.1, 0.2, ..., 0.5 s. With a time step of 0.005 s, we therefore need to output results at every 20th time step and so we set `writeInterval` to 20.

OpenFOAM creates a new directory *named after the current time*, *e.g.* 0.1 s, on each occasion that it writes a set of data, as discussed in full in [section 4.1](#). In the `icoFoam` solver, it writes out the results for each field,  $\mathbf{U}$  and  $p$ , into the time directories. For this case, the entries in the `controlDict` are shown below:

```

17 application      icoFoam;
18
19 startFrom        startTime;
20
21 startTime        0;
22
23 stopAt           endTime;
24
25 endTime          0.5;
26
27 deltaT           0.005;
28
29 writeControl     timeStep;
30
31 writeInterval    20;
32
33 purgeWrite       0;
34
35 writeFormat      ascii;
36
37 writePrecision   6;
38
39
```



```

40 writeCompression uncompressed;
41
42 timeFormat          general;
43
44 timePrecision      6;
45
46 runTimeModifiable yes;
47
48
49 // ***** //

```

### 2.1.1.5 Discretisation and linear-solver settings

The user specifies the choice of finite volume discretisation schemes in the *fvSchemes* dictionary in the *system* directory. The specification of the linear equation solvers and tolerances and other algorithm controls is made in the *fvSolution* dictionary, similarly in the *system* directory. The user is free to view these dictionaries but we do not need to discuss all their entries at this stage except for `pRefCell` and `pRefValue` in the *PISO* sub-dictionary of the *fvSolution* dictionary. In a closed incompressible system such as the cavity, pressure is relative: it is the pressure range that matters not the absolute values. In cases such as this, the solver sets a reference level by `pRefValue` in cell `pRefCell`. In this example both are set to 0. Changing either of these values will change the absolute pressure field, but not, of course, the relative pressures or velocity field.

### 2.1.2 Viewing the mesh

Before the case is run it is a good idea to view the mesh to check for any errors. The mesh is viewed in `paraFoam`, the post-processing tool supplied with OpenFOAM. The `paraFoam` post-processing is started by typing in the terminal from within the case directory

```
paraFoam
```

Alternatively, it can be launched from another directory location with an optional `-case` argument giving the case directory, *e.g.*

```
paraFoam -case $FOAM_RUN/tutorials/incompressible/icoFoam/cavity
```

This launches the ParaView window as shown in [Figure 6.1](#). In the Pipeline Browser, the user can see that ParaView has opened `cavity.OpenFOAM`, the module for the cavity case. **Before clicking the Apply button**, the user needs to select some geometry from the **Region Status** and panel. Because the case is small, it is easiest to select all the data by checking the box adjacent to the **Region Status** panel title, which automatically checks all individual components within the respective panel. The user should then click the **Apply** button to load the geometry into ParaView.

some general settings are applied as described in [section 6.1.5.1](#). **Please consult this section about these settings.**

The user should then open the **Display** panel that controls the visual representation of the selected module. Within the **Display** panel the user should do the following as shown in [Figure 2.3](#): (1) set **Color** by **Solid Color**; (2) click **Set Solid Color** and select an appropriate colour *e.g.* black (for a white background); (3) in the **Style** panel, select **Wireframe** from the **Representation** menu. The background colour can be set by selecting **View Settings...** from **Edit** in the top menu panel.

Especially the first time the user starts ParaView, **it is recommended** that they manipulate the view as described in [section 6.1.5](#). In particular, since this is a 2D case, it is recommended that **Use Parallel Projection** is selected in the **General** panel of **View**

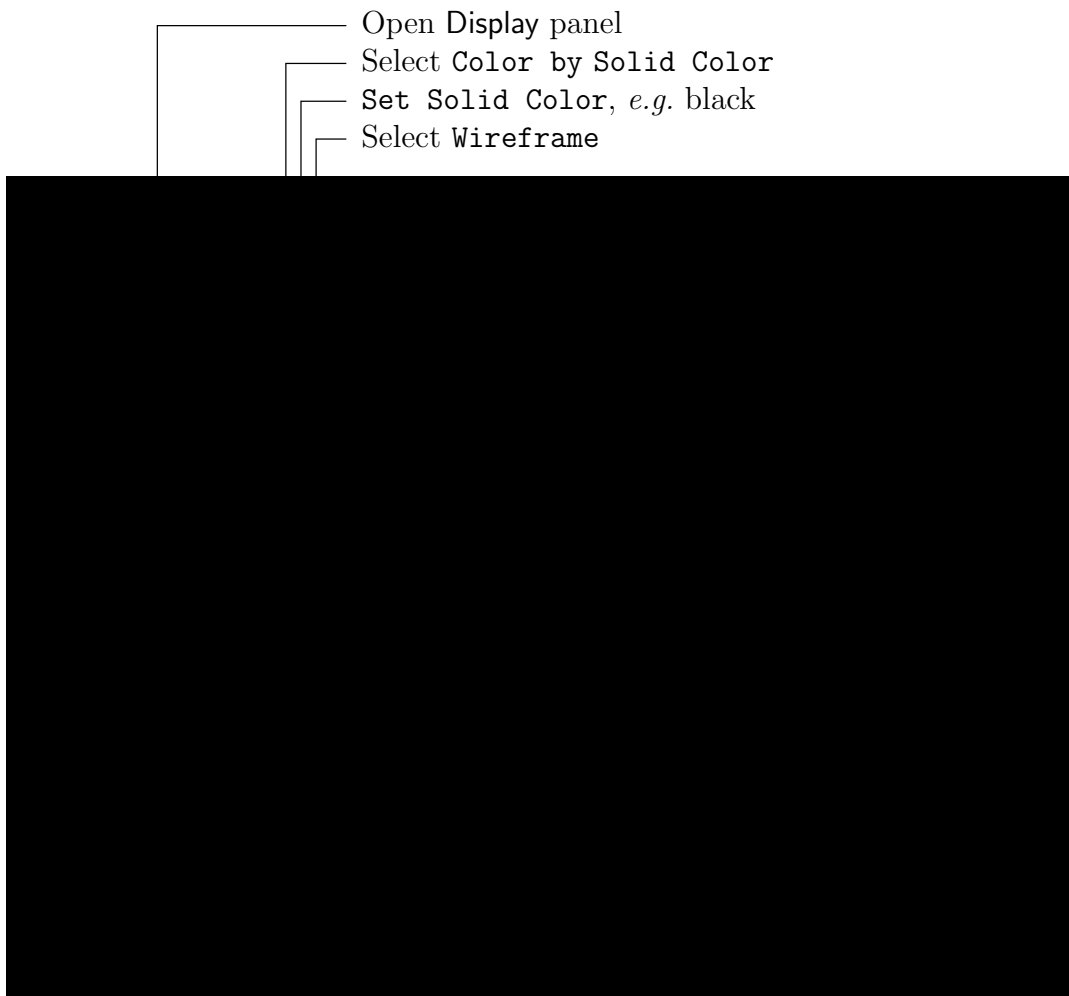

Figure 2.3: Viewing the mesh in paraFoam.

`Settings` window selected from the `Edit` menu. The `Orientation Axes` can be toggled on and off in the `Annotation` window or moved by drag and drop with the mouse.

### 2.1.3 Running an application

Like any UNIX/Linux executable, OpenFOAM applications can be run in two ways: as a foreground process, *i.e.* one in which the shell waits until the command has finished before giving a command prompt; as a background process, one which does not have to be completed before the shell accepts additional commands.

On this occasion, we will run `icoFoam` in the foreground. The `icoFoam` solver is executed either by entering the case director034(h)-0.310405(e)-6.37 amwã

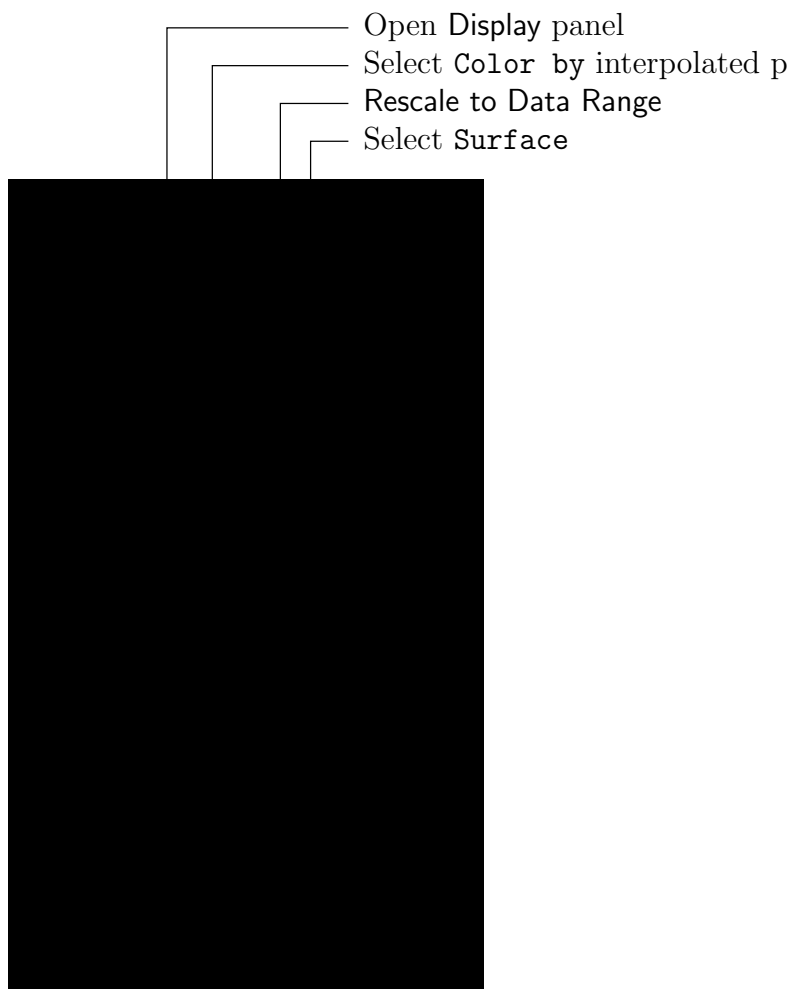

Figure 2.4: Displaying pressure contours for the cavity case.

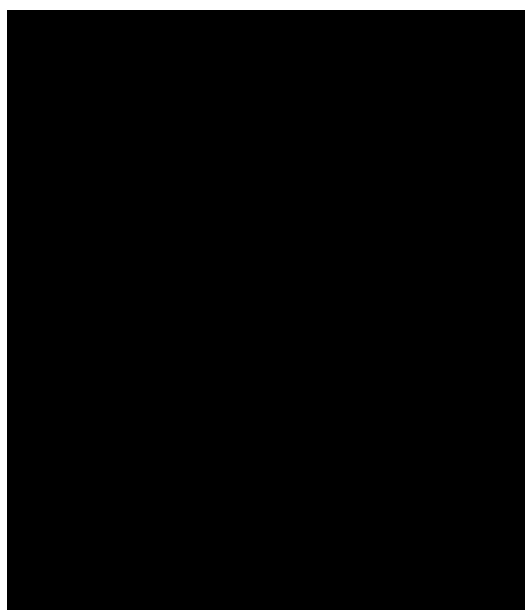



Figure 2.5: Pressures in the cavity case.



## 2.1.4 Post-processing

As soon as results are written to time directories, they can be viewed using `paraFoam`. Return to the `paraFoam` window and select the **Properties** panel for the `cavity.OpenFOAM` case module. If the correct window panels for the case module do not seem to be present at any time, please ensure that: `cavity.OpenFOAM` is highlighted in blue; **eye** button alongside it is switched on to show the graphics are enabled;

To prepare `paraFoam` to display the data of interest, we must first load the data at the required run time of 0.5 s. If the case was run while `ParaView` was open, the output data in time directories will not be automatically loaded within `ParaView`. To load the data the user should select **Update GUI** in the **Properties** window and then click the green **Apply** button. The time data will be loaded into `ParaView`.

### 2.1.4.1 Isosurface and contour plots

To view pressure, the user should open the **Display** panel since it that controls the visual representation of the selected module. To make a simple plot of pressure, the user should select the following, as described in detail in [Figure 2.4](#): in the **Style** panel, select **Surface** from the **Representation** menu; in the **Color** panel, select **Color** by  and **Rescale** to **Data Range**. Now in order to view the solution at  $t = 0.5$  s, the user can use the **VCR Controls** or **Current Time Controls** to change the current time to 0.5. These are located in the toolbars below the menus at the top of the `ParaView` window, as shown in [Figure 6.4](#). The pressure field solution has, as expected, a region of low pressure at the top left of the cavity and one of high pressure at the top right of the cavity as shown in [Figure 2.5](#).

With the point icon () the pressure field is interpolated across each cell to give a continuous appearance. Instead if the user selects the cell icon, () from the **Color** by menu, a single value for pressure will be attributed to each cell so that each cell will be denoted by a single colour with no grading.

A colour bar can be included by either by clicking the **Toggle Color Legend Visibility** button in the **Active Variable Controls** toolbar, or by selecting **Show Color Legend** from the **View** menu. Clicking the **Edit Color Map** button, either in the **Active Variable Controls** toolbar or in the **Color** panel of the **Display** window, the user can set a range of attributes of the colour bar, such as text size, font selection and numbering format for the scale. The colour bar can be located in the image window by drag and drop with the mouse.

New versions of `ParaView` default to using a colour scale of blue to white to red rather than the more common blue to green to red (rainbow). Therefore *the first time* that the user executes `ParaView`, they may wish to change the colour scale. This can be done by selecting **Choose Preset** in the **Color Scale Editor** and selecting **Blue to Red Rainbow**. After clicking the **OK** confirmation button, the user can click the **Make Default** button so that `ParaView` will always adopt this type of colour bar.

If the user rotates the image, they can see that they have now coloured the complete geometry surface by the pressure. In order to produce a genuine contour plot the user should first create a cutting plane, or ‘slice’, through the geometry using the **Slice** filter as described in [section 6.1.6.1](#). The cutting plane should be centred at (0.05, 0.05, 0.005) and its normal should be set to (0, 0, 1). Having generated the cutting plane, the contours can be created using by the **Contour** filter described in [section 6.1.6](#).

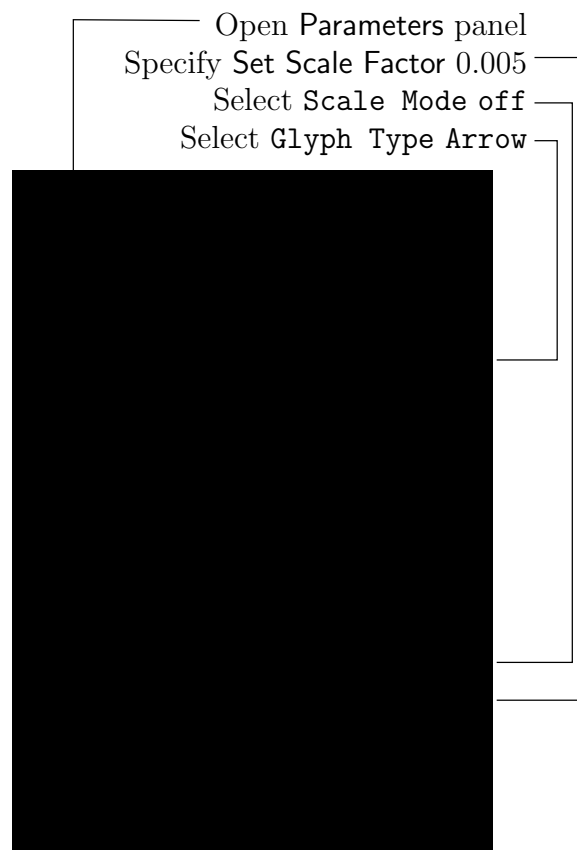

Figure 2.6: Properties panel for the Glyph filter.



Figure 2.7: Velocities in the cavity case.

### 2.1.4.2 Vector plots

Before we start to plot the vectors of the flow velocity, it may be useful to remove other modules that have been created, *e.g.* using the **Slice** and **Contour** filters described above. These can: either be deleted entirely, by highlighting the relevant module in the **Pipeline Browser** and clicking **Delete** in their respective **Properties** panel; or, be disabled by toggling the eye button for the relevant module in the **Pipeline Browser**.

We now wish to generate a vector glyph for velocity at the centre of each cell. We first need to filter the data to cell centres as described in [section 6.1.7.1](#). With the `cavity.OpenFOAM` module highlighted in the **Pipeline Browser**, the user should select **Cell Centers** from the **Filter** menu and then click **Apply**.

With these **Centers** highlighted in the **Pipeline Browser**, the user should then select **Glyph** from the **Filter** menu. The **Properties** window panel should appear as shown in [Figure 2.6](#). In the resulting **Properties** panel, the velocity field, **U**, is automatically selected in the **vectors** menu, since it is the only vector field present. By default the **Scale Mode** for the glyphs will be **Vector Magnitude** of velocity but, since we may wish to view the velocities throughout the domain, the user should instead select **off** and **Set Scale Factor** to 0.005. On clicking **Apply**, the glyphs appear but, probably as a single colour, *e.g.* white. The user should colour the glyphs by velocity magnitude which, as usual, is controlled by setting **Color** by **U** in the **Display** panel. The user should also select **Show Color Legend** in **Edit Color Map**. The output is shown in [Figure 2.7](#), in which uppercase Times Roman fonts are selected for the **Color Legend** headings and the labels are specified to 2 fixed significant figures by deselecting **Automatic Label Format** and entering `%-#6.2f` in the **Label Format** text box. The background colour is set to white in the **General** panel of **View Settings** as described in [section 6.1.5.1](#).

### 2.1.4.3 Streamline plots

Again, before the user continues to post-process in **ParaView**, they should disable modules such as those for the vector plot described above. We now wish to plot a streamlines of velocity as described in [section 6.1.8](#).

With the `cavity.OpenFOAM` module highlighted in the **Pipeline Browser**, the user should then select **Stream Tracer** from the **Filter** menu and then click **Apply**. The **Properties** window panel should appear as shown in [Figure 2.8](#). The **Seed** points should be specified along a **Line Source** running vertically through the centre of the geometry, *i.e.* from (0.05, 0, 0.005) to (0.05, 0.1, 0.005). For the image in this guide we used: a point **Resolution** of 21; **Max Propagation by Length** 0.5; **Initial Step Length** by **Cell Length** 0.01; and, **Integration Direction** BOTH. The **Runge-Kutta 2 IntegratorType** was used with default parameters.

On clicking **Apply** the tracer is generated. The user should then select **Tube** from the **Filter** menu to produce high quality streamline images. For the image in this report, we used: **Num. sides** 6; **Radius** 0.0003; and, **Radius factor** 10. The streamtubes are coloured by velocity magnitude. On clicking **Apply** the image in [Figure 2.9](#) should be produced.

## 2.1.5 Increasing the mesh resolution

The mesh resolution will now be increased by a factor of two in each direction. The results from the coarser mesh will be mapped onto the finer mesh to use as initial conditions for the problem. The solution from the finer mesh will then be compared with those from the coarser mesh.

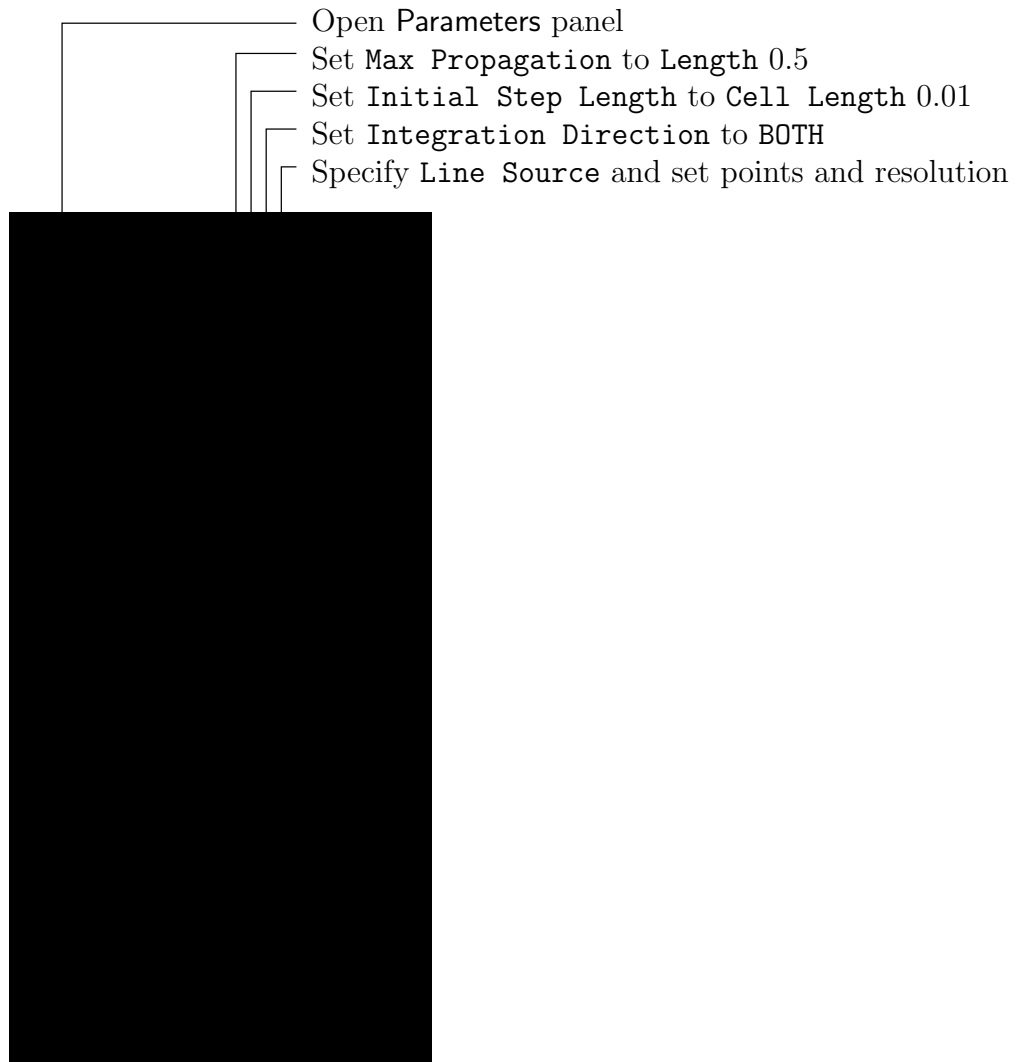

Figure 2.8: Properties panel for the Stream Tracer filter.

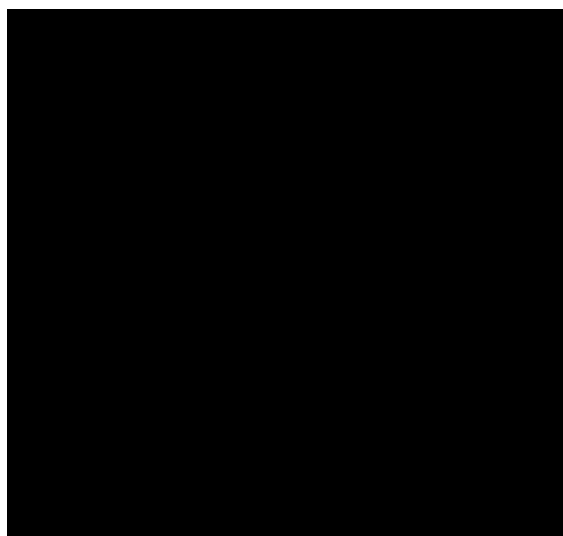

Figure 2.9: Streamlines in the cavity case.

### 2.1.5.1 Creating a new case using an existing case

We now wish to create a new case named `cavityFine` that is created from `cavity`. The user should therefore clone the `cavity` case and edit the necessary files. First the user should create a new case directory at the same directory level as the `cavity` case, *e.g.*

```
cd $FOAM_RUN/tutorials/incompressible/icoFoam
mkdir cavityFine
```

The user should then copy the base directories from the `cavity` case into `cavityFine`, and then enter the `cavityFine` case.

```
cp -r cavity/constant cavityFine
cp -r cavity/system cavityFine
cd cavityFine
```

### 2.1.5.2 Creating the finer mesh

We now wish to increase the number of cells in the mesh by using `blockMesh`. The user should open the `blockMeshDict` file in an editor and edit the block specification. The blocks are specified in a list under the `blocks` keyword. The syntax of the block definitions is described fully in [section 5.3.1.3](#); at this stage it is sufficient to know that following `hex` is first the list of vertices in the block, then a list (or vector) of numbers of cells in each direction. This was originally set to `(20 20 1)` for the `cavity` case. The user should now change this to `(40 40 1)` and save the file. The new refined mesh should then be created by running `blockMesh` as before.

### 2.1.5.3 Mapping the coarse mesh results onto the fine mesh

The `mapFields` utility maps one or more fields relating to a given geometry onto the corresponding fields for another geometry. In our example, the fields are deemed ‘consistent’ because the geometry and the boundary types, or conditions, of both source and target fields are identical. We use the `-consistent` command line option when executing `mapFields` in this example.

The field data that `mapFields` maps is read from the time directory specified by `startFrom/startTime` in the `controlDict` of the target case, *i.e.* those **into which** the results are being mapped. In this example, we wish to map the final results of the coarser mesh from case `cavity` onto the finer mesh of case `cavityFine`. Therefore, since these results are stored in the `0.5` directory of `cavity`, the `startTime` should be set to 0.5 s in the `controlDict` dictionary and `startFrom` should be set to `startTime`.

The case is ready to run `mapFields`. Typing `mapFields -help` quickly shows that `mapFields` requires the source case directory as an argument. We are using the `-consistent` option, so the utility is executed from within the `cavityFine` directory by

```
mapFields ../cavity -consistent
```

The utility should run with output to the terminal including:

```
Source: ".." "cavity"
Target: "." "cavityFine"

Create databases as time

Source time: 0.5
```



```

Target time: 0.5
Create meshes

Source mesh size: 400   Target mesh size: 1681

Consistently creating and mapping fields for time 0.5

    interpolating p
    interpolating U

End

```

#### 2.1.5.4 Control adjustments

To maintain a Courant number of less than 1, as discussed in [section 2.1.1.4](#), the time step must now be halved since the size of all cells has halved. Therefore `deltaT` should be set to 0.0025 s in the *controlDict* dictionary. Field data is currently written out at an interval of a fixed number of time steps. Here we demonstrate how to specify data output at fixed intervals of time. Under the `writeControl` keyword in *controlDict*, instead of requesting output by a fixed number of time steps with the `timeStep` entry, a fixed amount of run time can be specified between the writing of results using the `runTime` entry. In this case the user should specify output every 0.1 and therefore should set `writeInterval` to 0.1 and `writeControl` to `runTime`. Finally, since the case is starting with a the solution obtained on the coarse mesh we only need to run it for a short period to achieve reasonable convergence to steady-state. Therefore the `endTime` should be set to 0.7 s. Make sure these settings are correct and then save the file.

#### 2.1.5.5 Running the code as a background process

The user should experience running `icoFoam` as a background process, redirecting the terminal output to a *log* file that can be viewed later. From the *cavityFine* directory, the user should execute:

```

icoFoam > log &
cat log

```

#### 2.1.5.6 Vector plot with the refined mesh

The user can open multiple cases simultaneously in `ParaView`; essentially because each new case is simply another module that appears in the `Pipeline Browser`. There is one minor inconvenience when opening a new case in `ParaView` because there is a prerequisite that the selected data is a file with a name that has an extension. However, in `OpenFOAM`, each case is stored in a multitude of files with no extensions within a specific directory structure. The solution, that the `paraFoam` script performs automatically, is to create a dummy file with the extension *.OpenFOAM* — hence, the *cavity* case module is called `cavity.OpenFOAM`.

However, if the user wishes to open another case directly from within `ParaView`, they need to create such a dummy file. For example, to load the *cavityFine* case the file would be created by typing at the command prompt:

```

cd $FOAM_RUN/tutorials/incompressible/icoFoam
touch cavityFine/cavityFine.OpenFOAM

```

Now the *cavityFine* case can be loaded into `ParaView` by selecting `Open` from the `File` menu, and having navigated the directory tree, selecting `cavityFine.OpenFOAM`. The user

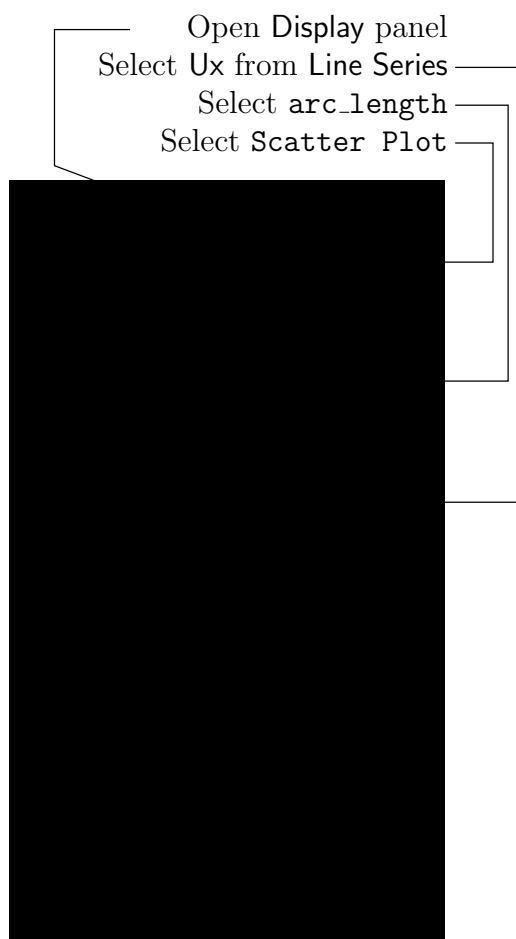

Figure 2.10: Selecting fields for graph plotting.

can now make a vector plot of the results from the refined mesh in **ParaView**. The plot can be compared with the **cavity** case by enabling glyph images for both case simultaneously.

### 2.1.5.7 Plotting graphs

The user may wish to visualise the results by extracting some scalar measure of velocity and plotting 2-dimensional graphs along lines through the domain. OpenFOAM is well equipped for this kind of data manipulation. There are numerous utilities that do specialised data manipulations, and some, simpler calculations are incorporated into a single utility **foamCalc**. As a utility, it is unique in that it is executed by

```
foamCalc <calcType> <fieldName1 ... fieldNameN>
```

The calculator operation is specified in **<calcType>**; at the time of writing, the following operations are implemented: **addSubtract**; **randomise**; **div**; **components**; **mag**; **magGrad**; **magSqr**; **interpolate**. The user can obtain the list of **<calcType>** by deliberately calling one that does not exist, so that **foamCalc** throws up an error message and lists the types available, *e.g.*

```
>> foamCalc xxxx
Selecting calcType xxxx
    unknown calcType type xxxx, constructor not in hash table
    Valid calcType selections are:

8
(
randomise
```

```

magSqr
magGrad
addSubtract
div
mag
interpolate
components
)

```

The `components` and `mag calcTypes` provide useful scalar measures of velocity. When “foamCalc components U” is run on a case, say *cavity*, it reads in the velocity vector field from each time directory and, in the corresponding time directories, writes scalar fields `Ux`, `Uy` and `Uz` representing the  $x$ ,  $y$  and  $z$  components of velocity. Similarly “foamCalc mag U” writes a scalar field `magU` to each time directory representing the magnitude of velocity.

The user can run `foamCalc` with the `components calcType` on both `cavity` and `cavityFine` cases. For example, for the `cavity` case the user should execute the following command:

```
foamCalc components U -case $FOAM_RUN/tutorials1.5/icoFoam/cavity
```

The individual components can be plotted as a graph in `ParaView`. It is quick, convenient and has reasonably good control over labelling and formatting, so the printed output is a fairly good standard. However, to produce graphs for publication, users may prefer to write raw data and plot it with a dedicated graphing tool, such as `gnuplot` or `Grace/xmgr`. To do this, we recommend using the `sample` utility, described in [section 6.5](#) and [section 2.2.3](#).

*Before commencing plotting*, the user needs to load the newly generated `Ux`, `Uy` and `Uz` fields into `ParaView`. To do this, the user should check the `Update GUI` button at the top of the `Properties` panel of the base module they are working on, *e.g.* `cavity.OpenFOAM`. Clicking `Apply` will then cause the new fields to be loaded into `ParaView` which will appear in the `Vol Field Status` window. Ensure the new fields are selected and the changes are applied, *i.e.* click `Apply` again if necessary. *Also*, data is interpolated incorrectly at boundaries if the boundary regions are selected in the `Region Status` panel. Therefore the user should *deselect the patches* in the `Region Status` panel, *i.e.* `movingWall`, `fixedWall` and `frontAndBack`, and apply the changes.

Now, in order to display a graph in `ParaView` the user should select the module of interest, *e.g.* `cavity.OpenFOAM` and apply the `Plot Over Line` filter from the `Filter->Data Analysis` menu. This opens up a new `XY Plot` window beside the existing `3D View` window. A `ProbeLine` module is created in which the user can specify the end points of the line in the `Properties` panel. In this example, the user should position the line vertically up the centre of the domain, *i.e.* from  $(0.05, 0, 0.005)$  to  $(0.05, 0.1, 0.005)$ , in the `Point1` and `Point2` text boxes. The `Resolution` can be set to 100.

On clicking `Apply`, a graph is generated in the `XY Plot` window. In the `Display` panel, the user should choose `Scatter Plot` from the `Plot Type` menu, with `Attribute Mode Point Data`. The `Use Data Array` option can be selected for the `X Axis Data`, taking the `arc_length` option so that the x-axis of the graph represents distance from the base of the cavity.

The user can choose the fields to be displayed in the `Line Series` panel of the `Display` window. From the list of scalar fields to be displayed, it can be seen that the magnitude and components of vector fields are available by default, *e.g.* displayed as `U:X`, so that it was not necessary to create `Ux` using `foamCalc`. Nevertheless, the user should *deselect* all series except `Ux` (or `U:x`). A square colour box in the adjacent column to the selected series indicates the line colour. The user can edit this most easily by a double click of the mouse over that selection.

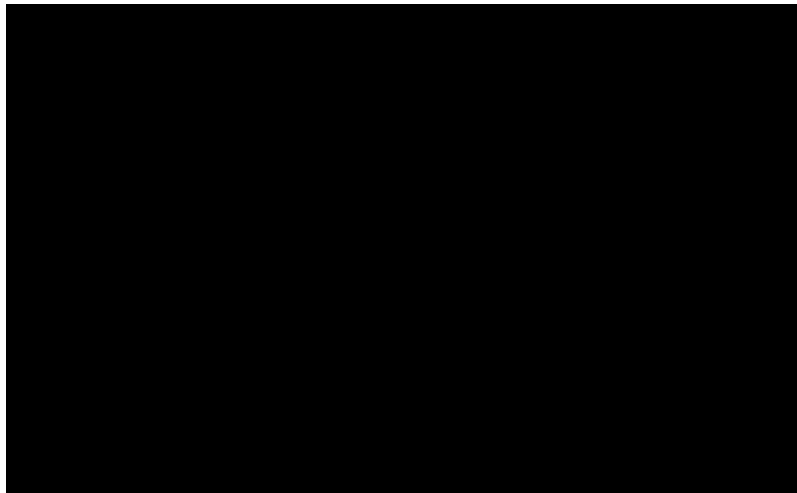

Figure 2.11: Plotting graphs in paraFoam.

In order to format the graph, the user should move over to the XY Plot itself. Now, with the cursor over the graph, the user can click the right mouse-button and select **Properties** from the small floating menu produced. A **Chart Options** window appears with **General** settings for title and legend and menus for each axis. The menu for each axis can be expanded by a double click to reveal individual menus for **Layout** and **Title**, one for each axis. The user can set font, colour and alignment of the axes titles, and has several options for axis range and labels in linear or logarithmic scales.

**Figure 2.11** is a graph produced using ParaView. The user can produce a graph however he/she wishes. For information, the graph in **Figure 2.11** was produced with the options for axes of: **Standard** type of Notation; **Specify Axis Range** selected; titles in **Sans Serif 12** font. The graph is displayed as a set of points rather than a line by activating the **Enable Line Series** button in the **Display** window. Note: if this button appears to be inactive by being “greyed out”, it can be made active by selecting and deselecting the sets of variables in the **Line Series** panel. Once the **Enable Line Series** button is selected, the **Line Style** and **Marker Style** can be adjusted to the user’s preference.

## 2.1.6 Introducing mesh grading

The error in any solution will be more pronounced in regions where the form of the true solution differ widely from the form assumed in the chosen numerical schemes. For example a numerical scheme based on linear variations of variables over cells can only generate an exact solution if the true solution is itself linear in form. The error is largest in regions where the true solution deviates greatest from linear form, *i.e.* where the change in gradient is largest. Error decreases with cell size.

It is useful to have an intuitive appreciation of the form of the solution before setting up any problem. It is then possible to anticipate where the errors will be largest and to grade the mesh so that the smallest cells are in these regions. In the cavity case the large variations in velocity can be expected near a wall and so in this part of the tutorial the mesh will be graded to be smaller in this region. By using the same number of cells, greater accuracy can be achieved without a significant increase in computational cost.

A mesh of  $20 \times 20$  cells with grading towards the walls will be created for the lid-driven cavity problem and the results from the finer mesh of [section 2.1.5.2](#) will then be mapped onto the graded mesh to use as an initial condition. The results from the graded mesh will be compared with those from the previous meshes. Since the changes to the `blockMeshDict` dictionary are fairly substantial, the case used for this part of the tutorial,

cavityGrade, is supplied in the `$FOAM_RUN/tutorials/incompressible/icoFoam` directory.

### 2.1.6.1 Creating the graded mesh

The mesh now needs 4 blocks as different mesh grading is needed on the left and right and top and bottom of the domain. The block structure for this mesh is shown in [Figure 2.12](#). The user can view the `blockMeshDict` file in the `constant/polyMesh` subdirectory of cavi-

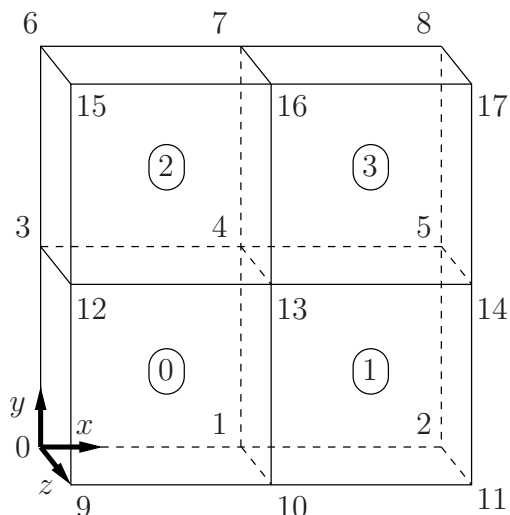

Figure 2.12: Block structure of the graded mesh for the cavity (block numbers encircled).

tyGrade; for completeness the key elements of the `blockMeshDict` file are also reproduced below. Each block now has 10 cells in the  $x$  and  $y$  directions and the ratio between largest and smallest cells is 2.

```

17  convertToMeters 0.1;
18
19  vertices
20  (
21      (0 0 0)
22      (0.5 0 0)
23      (1 0 0)
24      (0 0.5 0)
25      (0.5 0.5 0)
26      (1 0.5 0)
27      (0 1 0)
28      (0.5 1 0)
29      (1 1 0)
30      (0 0 0.1)
31      (0.5 0 0.1)
32      (1 0 0.1)
33      (0 0.5 0.1)
34      (0.5 0.5 0.1)
35      (1 0.5 0.1)
36      (0 1 0.1)
37      (0.5 1 0.1)
38      (1 1 0.1)
39  );
40
41  blocks
42  (
43      hex (0 1 4 3 9 10 13 12) (10 10 1) simpleGrading (2 2 1)
44      hex (1 2 5 4 10 11 14 13) (10 10 1) simpleGrading (0.5 2 1)
45      hex (3 4 7 6 12 13 16 15) (10 10 1) simpleGrading (2 0.5 1)
46      hex (4 5 8 7 13 14 17 16) (10 10 1) simpleGrading (0.5 0.5 1)
47  );
48
49  edges
50  (
51  );
52
53  patches
54  (
55      wall movingWall
56      (

```

```

57         (6 15 16 7)
58         (7 16 17 8)
59     )
60     wall fixedWalls
61     (
62         (3 12 15 6)
63         (0 9 12 3)
64         (0 1 10 9)
65         (1 2 11 10)
66         (2 5 14 11)
67         (5 8 17 14)
68     )
69     empty frontAndBack
70     (
71         (0 3 4 1)
72         (1 4 5 2)
73         (3 6 7 4)
74         (4 7 8 5)
75         (9 10 13 12)
76         (10 11 14 13)
77         (12 13 16 15)
78         (13 14 17 16)
79     )
80 );
81
82 mergePatchPairs
83 (
84 );
85
86 // ***** //

```

Once familiar with the *blockMeshDict* file for this case, the user can execute `blockMesh` from the command line. The graded mesh can be viewed as before using `paraFoam` as described in [section 2.1.2](#).

### 2.1.6.2 Changing time and time step

The highest velocities and smallest cells are next to the lid, therefore the highest Courant number will be generated next to the lid, for reasons given in [section 2.1.1.4](#). It is therefore useful to estimate the size of the cells next to the lid to calculate an appropriate time step for this case.

When a nonuniform mesh grading is used, `blockMesh` calculates the cell sizes using a geometric progression. Along a length  $l$ , if  $n$  cells are requested with a ratio of  $R$  between the last and first cells, the size of the smallest cell,  $\delta x_s$ , is given by:

$$\delta x_s = l \frac{r - 1}{\alpha r - 1} \quad (2.5)$$

where  $r$  is the ratio between one cell size and the next which is given by:

$$r = R^{\frac{1}{n-1}} \quad (2.6)$$

and

$$\alpha = \begin{cases} R & \text{for } R > 1, \\ 1 - r^{-n} + r^{-1} & \text{for } R < 1. \end{cases} \quad (2.7)$$

For the `cavityGrade` case the number of cells in each direction in a block is 10, the ratio between largest and smallest cells is 2 and the block height and width is 0.05 m. Therefore the smallest cell length is 3.45 mm. From [Equation 2.2](#), the time step should be less than 3.45 ms to maintain a Courant of less than 1. To ensure that results are written out at convenient time intervals, the time step `deltaT` should be reduced to 2.5 ms and the `writeInterval` set to 40 so that results are written out every 0.1 s. These settings can be viewed in the *cavityGrade/system/controlDict* file.

The `startTime`

### 2.1.6.3 Mapping fields

As in [section 2.1.5.3](#), use `mapFields` to map the final results from case `cavityFine` onto the mesh for case `cavityGrade`. Enter the `cavityGrade` directory and execute `mapFields` by:

```
cd $FOAM_RUN/tutorials/incompressible/icoFoam/cavityGrade
mapFields ../cavityFine -consistent
```

Now run `icoFoam` from the case directory and monitor the run time information. View the converged results for this case and compare with other results using post-processing tools described previously in [section 2.1.5.6](#) and [section 2.1.5.7](#).

## 2.1.7 Increasing the Reynolds number

The cases solved so far have had a Reynolds number of 10. This is very low and leads to a stable solution quickly with only small secondary vortices at the bottom corners of the cavity. We will now increase the Reynolds number to 50, at which point the solution takes a noticeably longer time to converge. The coarsest mesh in case `cavity` will be used initially. The user should make a copy of the `cavity` case and name it `cavityHighRe` by typing:

```
cd $FOAM_RUN/tutorials/incompressible/icoFoam
cp -r cavity cavityHighRe
```

### 2.1.7.1 Pre-processing

Enter the the `cavityHighRe` case and edit the `transportProperties` dictionary. Since the Reynolds number is required to be increased by a factor of 10, decrease the kinematic viscosity by a factor of 10, *i.e.* to  $1 \times 10^{-3} \text{ m}^2 \text{ s}^{-1}$ . We can now run this case by restarting from the solution at the end of the `cavity` case run. To do this we can use the option of setting the `startFrom` keyword to `latestTime` so that `icoFoam` takes as its initial data the values stored in the directory corresponding to the most recent time, *i.e.* `0.5`. The `endTime` should be set to 2 s.

### 2.1.7.2 Running the code

Run `icoFoam` for this case from the case directory and view the run time information. When running a job in the background, the following UNIX commands can be useful:

`nohup` enables a command to keep running after the user who issues the command has logged out;

`nice` changes the priority of the job in the kernel's scheduler; a niceness of -20 is the highest priority and 19 is the lowest priority.

This is useful, for example, if a user wishes to set a case running on a remote machine and does not wish to monitor it heavily, in which case they may wish to give it low priority on the machine. In that case the `nohup` command allows the user to log out of a remote machine he/she is running on and the job continues running, while `nice` can set the priority to 19. For our case of interest, we can execute the command in this manner as follows:



```
cd $FOAM_RUN/tutorials/incompressible/icoFoam/cavityHighRe
nohup nice -n 19 icoFoam > log &
cat log
```

In previous runs you may have noticed that `icoFoam` stops solving for velocity `U` quite quickly but continues solving for pressure `p` for a lot longer or until the end of the run. In practice, once `icoFoam` stops solving for `U` and the initial residual of `p` is less than the tolerance set in the `fvSolution` dictionary (typically  $10^{-6}$ ), the run has effectively converged and can be stopped once the field data has been written out to a time directory. For example, at convergence a sample of the `log` file from the run on the `cavityHighRe` case appears as follows in which the velocity has already converged after 1.62 s and initial pressure residuals are small; `No Iterations 0` indicates that the solution of `U` has stopped:

```
1
2      63
3
4      o  n  36  88
5  L/B # So ng o , n  6, n  6,
6  L/B # So ng o , n  6, n  6,
7  L/B # So ng o , n  6, n  6,
8  L/B # So ng o , n  6, n  6,
9  L/B # So ng o , n  6, n  6,
10 L/B # So ng o , n  6, n  6,
11 L/B # So ng o , n  6, n  6,
12 L/B # So ng o , n  6, n  6,
13 L/B # So ng o , n  6, n  6,
14 L/B # So ng o , n  6, n  6,
15 L/B # So ng o , n  6, n  6,
16 L/B # So ng o , n  6, n  6,
17 L/B # So ng o , n  6, n  6,
18
19      63
20
21      o  n  36  88
22 L/B # So ng o , n  6, n  6,
23 L/B # So ng o , n  6, n  6,
24 L/B # So ng o , n  6, n  6,
25 L/B # So ng o , n  6, n  6,
26 L/B # So ng o , n  6, n  6,
27 L/B # So ng o , n  6, n  6,
28 L/B # So ng o , n  6, n  6,
29 L/B # So ng o , n  6, n  6,
30 L/B # So ng o , n  6, n  6,
31 L/B # So ng o , n  6, n  6,
32 L/B # So ng o , n  6, n  6,
33 L/B # So ng o , n  6, n  6,
34 L/B # So ng o , n  6, n  6,
```

## 2.1.8 High Reynolds number flow

View the results in `paraFoam` and display the velocity vectors. The secondary vortices in the corners have increased in size somewhat. The user can then increase the Reynolds number further by decreasing the viscosity and then rerun the case. The number of vortices increases so the mesh resolution around them will need to increase in order to resolve the more complicated flow patterns. In addition, as the Reynolds number increases the time to convergence increases. The user should monitor residuals and extend the `endTime` accordingly to ensure convergence.

The need to increase spatial and temporal resolution then becomes impractical as the flow moves into the turbulent regime, where problems of solution stability may also occur. Of course, many engineering problems have very high Reynolds numbers and it is infeasible to bear the huge cost of solving the turbulent behaviour directly. Instead Reynolds-averaged stress (RAS) turbulence models are used to solve for the mean flow behaviour and calculate the statistics of the fluctuations. The standard  $k - \epsilon$  model with wall functions will be used in this tutorial to solve the lid-driven cavity case with a Reynolds number of  $10^4$ . Two extra variables are solved for:  $k$ , the turbulent kinetic energy; and,  $\epsilon$ , the turbulent dissipation rate. The additional equations and models for turbulent flow are implemented into a OpenFOAM solver called `pisoFoam`.



### 2.1.8.1 Pre-processing

Change directory to the cavity case in the `$FOAM_RUN/tutorials/incompressible/pisoFoam/ras` directory (N.B: the **pisoFoam/ras** directory). Generate the mesh by running `blockMesh` as before. Mesh grading towards the wall is not necessary when using the standard  $k - \varepsilon$  model with wall functions since the flow in the near wall cell is modelled, rather than having to be resolved.

From version 1.6 onwards, a range of wall function models is available in OpenFOAM that are applied as boundary conditions on individual patches. This enables different wall function models to be applied to different wall regions. The choice of wall function models are specified through the turbulent viscosity field,  $\nu_t$  in the `0/nut` file:

```

17
18 dimensions      [0 2 -1 0 0 0 0];
19
20 internalField    uniform 0;
21
22 boundaryField
23 {
24     movingWall
25     {
26         type      nutWallFunction;
27         value     uniform 0;
28     }
29     fixedWalls
30     {
31         type      nutWallFunction;
32         value     uniform 0;
33     }
34     frontAndBack
35     {
36         type      empty;
37     }
38 }
39
40
41 // ***** //

```

This case uses standard wall functions, specified by the `nutWallFunction` keyword entry one the `movingWall` and `fixedWalls` patches. Other wall function models include the rough wall functions, specified though the `nutRoughWallFunction` keyword.

The user should now open the field files for  $k$  and  $\varepsilon$  (`0/k` and `0/epsilon`) and examine their boundary conditions. For a wall boundary condition,  $\varepsilon$  is assigned a `epsilonWallFunction` boundary condition and a `kqRwallFunction` boundary condition is assigned to  $k$ . The latter is a generic boundary condition that can be applied to any field that are of a turbulent kinetic energy type, *e.g.*  $k$ ,  $q$  or Reynolds Stress  $R$ . The initial values for  $k$  and  $\varepsilon$  are set using an estimated fluctuating component of velocity  $\mathbf{U}'$  and a turbulent length scale,  $l$ .  $k$  and  $\varepsilon$  are defined in terms of these parameters as follows:

$$k = \frac{1}{2} \overline{\mathbf{U}' \cdot \mathbf{U}'} \quad (2.8)$$

$$\varepsilon = \frac{C^{0.75} k^{1.5}}{l} \quad (2.9)$$

where  $C$  is a constant of the  $k - \varepsilon$  model equal to 0.09. For a Cartesian coordinate system,  $k$  is given by:

$$k = \frac{1}{2} (U_x'^2 + U_y'^2 + U_z'^2) \quad (2.10)$$

where  $U_x'^2$ ,  $U_y'^2$  and  $U_z'^2$  are the fluctuating components of velocity in the  $x$ ,  $y$  and  $z$  directions respectively. Let us assume the initial turbulence is isotropic, *i.e.*  $U_x'^2 = U_y'^2 = U_z'^2$ , and equal to 5% of the lid velocity and that  $l$ , is equal to 20% of the box width, 0.1

m, then  $k$  and  $\varepsilon$  are given by:

$$U'_x = U'_y = U'_z = \frac{5}{100} 1 \text{ m s}^{-1} \quad (2.11)$$

$$\Rightarrow k = \frac{3}{2} \left( \frac{5}{100} \right)^2 \text{ m}^2 \text{ s}^{-2} = 3.75 \times 10^{-3} \text{ m}^2 \text{ s}^{-2} \quad (2.12)$$

$$\varepsilon = \frac{C^{0.75} k^{1.5}}{l} \approx 7.65 \times 10^{-4} \text{ m}^2 \text{ s}^{-3} \quad (2.13)$$

These form the initial conditions for  $k$  and  $\varepsilon$ . The initial conditions for  $\mathbf{U}$  and  $p$  are  $(0, 0, 0)$  and  $0$  respectively as before.

Prior to version 1.6 of OpenFOAM, the type of turbulence modelling method, *e.g.* RAS or large-eddy simulation (LES), was declared within each solver. This resulted in a lot of duplication of code in solver applications, where for most solvers that used RAS turbulence modelling, there would be an equivalent LES solver.

From version 1.6 however, the choice of turbulence modelling method is selectable at run-time through the `simulationType` keyword in `turbulenceProperties` dictionary. The user can view this file in the `constant` directory:

```

17
18 simulationType RASModel;
19
20
21 // ***** //

```

The options for `simulationType` are `laminar`, `RASmodel` and `LESmodel`. With `RASmodel` selected in this case, the choice of RAS modelling is specified in a `RASProperties` file, also in the `constant` directory. The turbulence model is selected by the `RASModel` entry from a long list of available models that are listed in [Table 3.9](#). The `kEpsilon` model should be selected which is the standard  $k-\varepsilon$  model; the user should also ensure that turbulence calculation is switched on.

The coefficients for each turbulence model are stored within the respective code with a set of default values. Setting the optional switch called `printCoeffs` to `on` will make the default values be printed to standard output, *i.e.* the terminal, when the model is called at run time. The coefficients are printed out as a subdictionary whose name is that of the model name with the word `Coeffs` appended, *e.g.* `kEpsilonCoeffs` in the case of the `kEpsilon` model. The coefficients of the model, *e.g.* `kEpsilon`, can be modified by optionally including that subdictionary within the `RASProperties` dictionary and adjusting values accordingly.

The user should next set the laminar kinematic viscosity in the `transportProperties` dictionary. To achieve a Reynolds number of  $10^4$ , a kinematic viscosity of  $10^{-5}$  m is required based on the Reynolds number definition given in [Equation 2.1](#).

Finally the user should set the `startTime`, `stopTime`, `deltaT` and the `writeInterval` in the `controlDict`. Set `deltaT` to 0.005 s to satisfy the Courant number restriction and the `endTime` to 10 s.

### 2.1.8.2 Running the code

Execute `pisFoam` by entering the case directory and typing “`pisFoam`”. In this case, where the viscosity is low, the boundary layer next to the moving lid is very thin and the cells next to the lid are comparatively large so the velocity at their centres are much less than the lid velocity. In fact, after  $\approx$

the solution time by increasing the time step to a level where the Courant number is much closer to 1. Therefore reset `deltaT` to 0.02 s and, on this occasion, set `startFrom` to `latestTime`. This instructs `pisoFoam` to read the start data from the latest time directory, *i.e.* `10.0`. The `endTime` should be set to 20 s since the run converges a lot slower than the laminar case. Restart the run as before and monitor the convergence of the solution. View the results at consecutive time steps as the solution progresses to see if the solution converges to a steady-state or perhaps reaches some periodically oscillating state. In the latter case, convergence may never occur but this does not mean the results are inaccurate.

### 2.1.9 Changing the case geometry

A user may wish to make changes to the geometry of a case and perform a new simulation. It may be useful to retain some or all of the original solution as the starting conditions for the new simulation. This is a little complex because the fields of the original solution are not consistent with the fields of the new case. However the `mapFields` utility can map fields that are inconsistent, either in terms of geometry or boundary types or both.

As an example, let us go to the `cavityClipped` case in the `icoFoam` directory which consists of the standard `cavity` geometry but with a square of length 0.04 m removed from the bottom right of the cavity, according to the `blockMeshDict` below:

```

17  convertToMeters 0.1;
18
19  vertices
20  (
21      (0 0 0)
22      (0.6 0 0)
23      (0 0.4 0)
24      (0.6 0.4 0)
25      (1 0.4 0)
26      (0 1 0)
27      (0.6 1 0)
28      (1 1 0)
29
30      (0 0 0.1)
31      (0.6 0 0.1)
32      (0 0.4 0.1)
33      (0.6 0.4 0.1)
34      (1 0.4 0.1)
35      (0 1 0.1)
36      (0.6 1 0.1)
37      (1 1 0.1)
38
39  );
40
41  blocks
42  (
43      hex (0 1 3 2 8 9 11 10) (12 8 1) simpleGrading (1 1 1)
44      hex (2 3 6 5 10 11 14 13) (12 12 1) simpleGrading (1 1 1)
45      hex (3 4 7 6 11 12 15 14) (8 12 1) simpleGrading (1 1 1)
46  );
47
48  edges
49  (
50  );
51
52  patches
53  (
54      wall lid
55      (
56          (5 13 14 6)
57          (6 14 15 7)
58      )
59      wall fixedWalls
60      (
61          (0 8 10 2)
62          (2 10 13 5)
63          (7 15 12 4)
64          (4 12 11 3)
65          (3 11 9 1)
66          (1 9 8 0)
67      )

```

```

68     empty frontAndBack
69     (
70         (0 2 3 1)
71         (2 5 6 3)
72         (3 6 7 4)
73         (8 9 11 10)
74         (10 11 14 13)
75         (11 12 15 14)
76     )
77 );
78
79 mergePatchPairs
80 (
81 );
82
83 // ***** //

```

Generate the mesh with `blockMesh`. The patches are set accordingly as in previous cavity cases. For the sake of clarity in describing the field mapping process, the upper wall patch is renamed `lid`, previously the `movingWall` patch of the original `cavity`.

In an inconsistent mapping, there is no guarantee that all the field data can be mapped from the source case. The remaining data must come from field files in the target case itself. Therefore field data must exist in the time directory of the target case before mapping takes place. In the `cavityClipped` case the mapping is set to occur at time 0.5 s, since the `startTime` is set to 0.5 s in the `controlDict`. Therefore the user needs to copy initial field data to that directory, *e.g.* from time 0:

```

cd $FOAM_RUN/tutorials/incompressible/icoFoam/cavityClipped
cp -r 0 0.5

```

Before mapping the data, the user should view the geometry and fields at 0.5 s.

Now we wish to map the velocity and pressure fields from `cavity` onto the new fields of `cavityClipped`. Since the mapping is inconsistent, we need to edit the `mapFieldsDict` dictionary, located in the `system` directory. The dictionary contains 2 keyword entries: `patchMap` and `cuttingPatches`. The `patchMap` list contains a mapping of patches from the source fields to the target fields. It is used if the user wishes a patch in the target field to inherit values from a corresponding patch in the source field. In `cavityClipped`, we wish to inherit the boundary values on the `lid` patch from `movingWall` in `cavity` so we must set the `patchMap` as:

```

patchMap
(
    lid movingWall
);

```

The `cuttingPatches` list contains names of target patches whose values are to be mapped from the source internal field through which the target patch cuts. In this case we will include the `fixedWalls` to demonstrate the interpolation process.

```

cuttingPatches
(
    fixedWalls
);

```

Now the user should run `mapFields`, from within the `cavityClipped` directory:

```

mapFields ../cavity

```



Figure 2.13: cavity solution velocity field mapped onto cavityClipped.



Figure 2.14: cavityClipped solution for velocity field.

The user can view the mapped field as shown in [Figure 2.13](#). The boundary patches have inherited values from the source case as we expected. Having demonstrated this, however, we actually wish to reset the velocity on the `fixedWalls` patch to  $(0, 0, 0)$ . Edit the `U` field, go to the `fixedWalls` patch and change the field from `nonuniform` to `uniform`  $(0, 0, 0)$ . The `nonuniform` field is a list of values that requires deleting in its entirety. Now run the case with `icoFoam`.

### 2.1.10 Post-processing the modified geometry

Velocity glyphs can be generated for the case as normal, first at time 0.5 s and later at time 0.6 s, to compare the initial and final solutions. In addition, we provide an outline of the geometry which requires some care to generate for a 2D case. The user should select **Extract Block** from the **Filter** menu and, in the **Parameter** panel, highlight the patches of interest, namely the lid and `fixedWalls`. On clicking **Apply**, these items of geometry can be displayed by selecting **Wireframe** in the **Display** panel. [Figure 2.14](#) displays the patches in black and shows vortices forming in the bottom corners of the modified geometry.

## 2.2 Stress analysis of a plate with a hole

This tutorial describes how to pre-process, run and post-process a case involving linear-elastic, steady-state stress analysis on a square plate with a circular hole at its centre. The plate dimensions are: side length 4 m and radius  $R = 0.5$  m. It is loaded with a uniform traction of  $\sigma = 10$  kPa over its left and right faces as shown in [Figure 2.15](#). Two symmetry planes can be identified for this geometry and therefore the solution domain need only cover a quarter of the geometry, shown by the shaded area in [Figure 2.15](#).

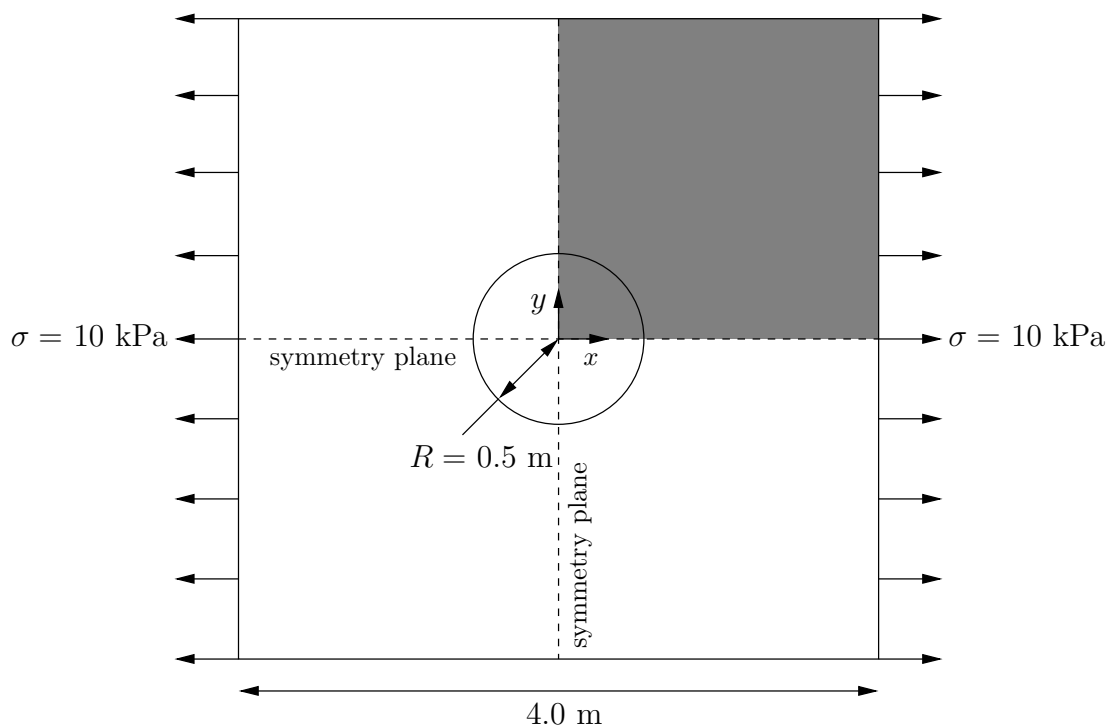

Figure 2.15: Geometry of the plate with a hole.

The problem can be approximated as 2-dimensional since the load is applied in the plane of the plate. In a Cartesian coordinate system there are two possible assumptions to take in regard to the behaviour of the structure in the third dimension: (1) the plane

stress condition, in which the stress components acting out of the 2D plane are assumed to be negligible; (2) the plane strain condition, in which the strain components out of the 2D plane are assumed negligible. The plane stress condition is appropriate for solids whose third dimension is thin as in this case; the plane strain condition is applicable for solids where the third dimension is thick.

An analytical solution exists for loading of an infinitely large, thin plate with a circular hole. The solution for the stress normal to the vertical plane of symmetry is

$$(\sigma_{xx})_{y=0} = \begin{cases} \sigma \left( 1 + \frac{R^2}{2y^2} + \frac{3R^4}{2y^4} \right) & \text{for } |y| \geq R \end{cases}$$

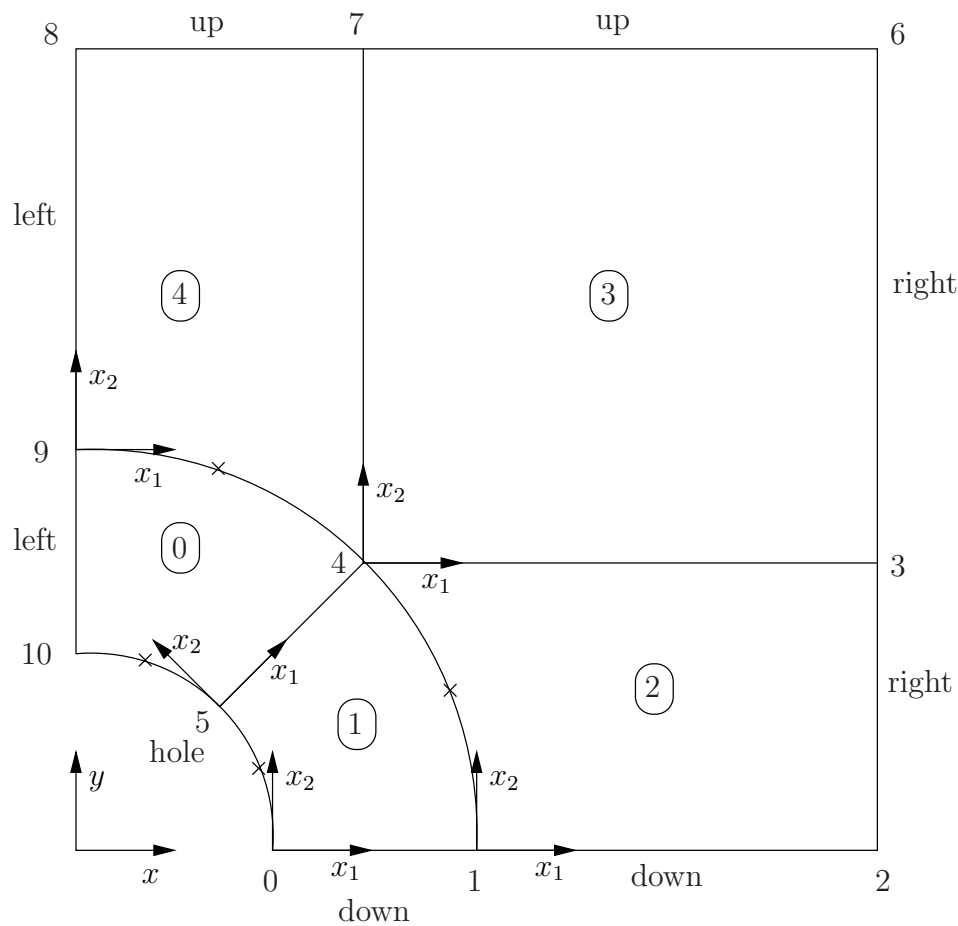

Figure 2.16: Block structure of the mesh for the plate with a hole.

```

52 );
53
54 edges
55 (
56     arc 0 5 (0.469846 0.17101 0)
57     arc 5 10 (0.17101 0.469846 0)
58     arc 1 4 (0.939693 0.34202 0)
59     arc 4 9 (0.34202 0.939693 0)
60     arc 11 16 (0.469846 0.17101 0.5)
61     arc 16 21 (0.17101 0.469846 0.5)
62     arc 12 15 (0.939693 0.34202 0.5)
63     arc 15 20 (0.34202 0.939693 0.5)
64 );
65
66 patches
67 (
68     symmetryPlane left
69     (
70         (8 9 20 19)
71         (9 10 21 20)
72     )
73     patch right
74     (
75         (2 3 14 13)
76         (3 6 17 14)
77     )
78     symmetryPlane down
79     (
80         (0 1 12 11)
81         (1 2 13 12)
82     )
83     patch up
84     (
85         (7 8 19 18)
86         (6 7 18 17)
87     )
88     patch hole
89     (
90         (10 5 16 21)

```



```

91         (5 0 11 16)
92     )
93     empty frontAndBack
94     (
95         (10 9 4 5)
96         (5 4 1 0)
97         (1 4 3 2)
98         (4 7 6 3)
99         (4 9 8 7)
100        (21 16 15 20)
101        (16 11 12 15)
102        (12 13 14 15)
103        (15 14 17 18)
104        (15 18 19 20)
105    )
106 );
107
108 mergePatchPairs
109 (
110 );
111
112 // *****

```

Until now, we have only specified straight edges in the geometries of previous tutorials but here we need to specify curved edges. These are specified under the `edges` keyword entry which is a list of non-straight edges. The syntax of each list entry begins with the type of curve, including `arc`, `simpleSpline`, `polyLine` *etc.*, described further in [section 5.3.1](#). In this example, all the edges are circular and so can be specified by the `arc` keyword entry. The following entries are the labels of the start and end vertices of the arc and a point vector through which the circular arc passes.

The blocks in this `blockMeshDict` do not all have the same orientation. As can be seen in [Figure 2.16](#) the  $x_2$  direction of block 0 is equivalent to the  $-x_1$  direction for block 4. This means care must be taken when defining the number and distribution of cells in each block so that the cells match up at the block faces.

6 patches are defined: one for each side of the plate, one for the hole and one for the front and back planes. The `left` and `down` patches are both a symmetry plane. Since this is a *geometric* constraint, it is included in the definition of the `mesh`, rather than being purely a specification on the boundary condition of the fields. Therefore they are defined as such using a special `symmetryPlane` type as shown in the `blockMeshDict`.

The `frontAndBack` patch represents the plane which is ignored in a 2D case. Again this is a geometric constraint so is defined within the mesh, using the `empty` type as shown in the `blockMeshDict`. For further details of boundary types and geometric constraints, the user should refer to [section 5.2.1](#).

The remaining patches are of the regular `patch` type. The mesh should be generated using `blockMesh` and can be viewed in `paraFoam` as described in [section 2.1.2](#). It should appear as in [Figure 2.17](#).

### 2.2.1.1 Boundary and initial conditions

Once the mesh generation is complete, the initial field with boundary conditions must be set. For a stress analysis case without thermal stresses, only displacement `D` needs to be set. The `0/D` is as follows:

```

17 dimensions      [0 1 0 0 0 0 0];
18
19 internalField    uniform (0 0 0);
20
21 boundaryField
22 {
23     left
24     {
25         type      symmetryPlane;
26     }
27     right
28     {

```



Figure 2.17: Mesh of the hole in a plate problem.

```

29         type          tractionDisplacement;
30         traction      uniform ( 10000 0 0 );
31         pressure      uniform 0;
32         value         uniform (0 0 0);
33     }
34     down
35     {
36         type          symmetryPlane;
37     }
38     up
39     {
40         type          tractionDisplacement;
41         traction      uniform ( 0 0 0 );
42         pressure      uniform 0;
43         value         uniform (0 0 0);
44     }
45     hole
46     {
47         type          tractionDisplacement;
48         traction      uniform ( 0 0 0 );
49         pressure      uniform 0;
50         value         uniform (0 0 0);
51     }
52     frontAndBack
53     {
54         type          empty;
55     }
56 }
57
58 // ***** //

```

Firstly, it can be seen that the displacement initial conditions are set to  $(0, 0, 0)$  m. The **left** and **down** patches **must** be both of `symmetryPlane` type since they are specified as such in the mesh description in the `constant/polyMesh/boundary` file. Similarly the `frontAndBack` patch is declared `empty`.

The other patches are traction boundary conditions, set by a specialist `traction` boundary type. The traction boundary conditions are specified by a linear combination of: (1) a boundary traction vector under keyword `traction`; (2) a pressure that produces a traction normal to the boundary surface that is defined as negative when pointing out of the surface, under keyword `pressure`. The `up` and `hole` patches are zero traction so the boundary traction and pressure are set to zero. For the `right` patch the traction should be  $(1e4, 0, 0)$  Pa and the pressure should be 0 Pa.

### 2.2.1.2 Mechanical properties

The physical properties for the case are set in the *mechanicalProperties* dictionary in the *constant* directory. For this problem, we need to specify the mechanical properties of steel given in Table 2.1. In the mechanical properties dictionary, the user must also set `planeStress` to `yes`.

Property	Units	Keyword	Value
Density	$\text{kg m}^{-3}$	<code>rho</code>	7854
Young's modulus	Pa	<code>E</code>	$2 \times 10^{11}$
Poisson's ratio	—	<code>nu</code>	0.3

Table 2.1: Mechanical properties for steel

### 2.2.1.3 Thermal properties

The temperature field variable `T` is present in the `solidDisplacementFoam` solver since the user may opt to solve a thermal equation that is coupled with the momentum equation through the thermal stresses that are generated. The user specifies at run time whether OpenFOAM should solve the thermal equation by the `thermalStress` switch in the *thermalProperties* dictionary. This dictionary also sets the thermal properties for the case, e.g. for steel as listed in Table 2.2.

Property	Units	Keyword	Value
Specific heat capacity	$\text{J kg}^{-1} \text{K}^{-1}$	<code>C</code>	434
Thermal conductivity	$\text{W m}^{-1} \text{K}^{-1}$	<code>k</code>	60.5
Thermal expansion coeff.	$\text{K}^{-1}$	<code>alpha</code>	$1.1 \times 10^{-5}$

Table 2.2: Thermal properties for steel

In this case we do not want to solve for the thermal equation. Therefore we must set the `thermalStress` keyword entry to `no` in the *thermalProperties* dictionary.

### 2.2.1.4 Control

As before, the information relating to the control of the solution procedure are read in from the *controlDict* dictionary. For this case, the `startTime` is 0 s. The time step is not important since this is a steady state case; in this situation it is best to set the time step `deltaT` to 1 so it simply acts as an iteration counter for the steady-state case. The `endTime`, set to 100, then acts as a limit on the number of iterations. The `writeInterval` can be set to 20.

The *controlDict* entries are as follows:

```

17
18 application      solidDisplacementFoam;
19
20 startFrom        startTime;
21
22 startTime        0;
23
24 stopAt           endTime;
25
26 endTime          100;
27
28 deltaT           1;
29
30 writeControl     timeStep;

```

```

31
32 writeInterval 20;
33
34 purgeWrite 0;
35
36 writeFormat ascii;
37
38 writePrecision 6;
39
40 writeCompression uncompressed;
41
42 timeFormat general;
43
44 timePrecision 6;
45
46 graphFormat raw;
47
48 runTimeModifiable yes;
49
50
51 // ***** //

```

### 2.2.1.5 Discretisation schemes and linear-solver control

Let us turn our attention to the *fvSchemes* dictionary. Firstly, the problem we are analysing is steady-state so the user should select **SteadyState** for the time derivatives in **timeScheme**. This essentially switches off the time derivative terms. Not all solvers, especially in fluid dynamics, work for both steady-state and transient problems but **solid-DisplacementFoam** does work, since the base algorithm is the same for both types of simulation.

The momentum equation in linear-elastic stress analysis includes several explicit terms containing the gradient of displacement. The calculations benefit from accurate and smooth evaluation of the gradient. Normally, in the finite volume method the discretisation is based on Gauss's theorem. The Gauss method is sufficiently accurate for most purposes but, in this case, the least squares method will be used. The user should therefore open the *fvSchemes* dictionary in the *system* directory and ensure the **leastSquares** method is selected for the **grad(U)** gradient discretisation scheme in the **gradSchemes** sub-dictionary:

```

17
18 d2dt2Schemes
19 {
20     default          steadyState;
21 }
22
23 gradSchemes
24 {
25     default          leastSquares;
26     grad(D)          leastSquares;
27     grad(T)          leastSquares;
28 }
29
30 divSchemes
31 {
32     default          none;
33     div(sigmaD)      Gauss linear;
34 }
35
36 laplacianSchemes
37 {
38     default          none;
39     laplacian(DD,D)  Gauss linear corrected;
40     laplacian(DT,T)  Gauss linear corrected;
41 }
42
43 interpolationSchemes
44 {
45     default          linear;
46 }
47
48 snGradSchemes
49 {
50     default          none;

```

```

51 }
52
53 fluxRequired
54 {
55     default          no;
56     D                yes;
57     T                no;
58 }
59
60
61 // ***** //

```

The *fvSolution* dictionary in the *system* directory controls the linear equation solvers and algorithms used in the solution. The user should first look at the *solvers* sub-dictionary and notice that the choice of *solver* for D is GAMG. The solver *tolerance* should be set to  $10^{-6}$  for this problem. The solver relative tolerance, denoted by *relTol*, sets the required reduction in the residuals within each iteration. It is uneconomical to set a tight (low) relative tolerance within each iteration since a lot of terms in each equation are explicit and are updated as part of the segregated iterative procedure. Therefore a reasonable value for the relative tolerance is 0.01, or possibly even higher, say 0.1, or in some cases even 0.9 (as in this case).

```

17
18 solvers
19 {
20     D
21     {
22         solver          GAMG;
23         tolerance       1e-06;
24         relTol          0.9;
25         smoother        GaussSeidel;
26         cacheAgglomeration true;
27         nCellsInCoarsestLevel 20;
28         agglomerator    faceAreaPair;
29         mergeLevels     1;
30     }
31
32     T
33     {
34         solver          GAMG;
35         tolerance       1e-06;
36         relTol          0.9;
37         smoother        GaussSeidel;
38         cacheAgglomeration true;
39         nCellsInCoarsestLevel 20;
40         agglomerator    faceAreaPair;
41         mergeLevels     1;
42     }
43 }
44
45 stressAnalysis
46 {
47     compactNormalStress yes;
48     nCorrectors         1;
49     D                   1e-06;
50 }
51
52
53 // ***** //

```

The *fvSolution* dictionary contains a sub-dictionary, *stressAnalysis* that contains some control parameters specific to the application solver. Firstly there is *nCorrectors* which specifies the number of outer loops around the complete system of equations, including traction boundary conditions *within each time step*. Since this problem is steady-state, we are performing a set of iterations towards a converged solution with the 'time step' acting as an iteration counter. We can therefore set *nCorrectors* to 1.

The D keyword specifies a convergence tolerance for the outer iteration loop, *i.e.* sets a level of initial residual below which solving will cease. It should be set to the desired solver tolerance specified earlier,  $10^{-6}$  for this problem.

## 2.2.2 Running the code

The user should run the code here in the background from the command line as specified below, so he/she can look at convergence information in the log file afterwards.

```
cd $FOAM_RUN/tutorials/stressAnalysis/solidDisplacementFoam/plateHole
solidDisplacementFoam > log &
```

The user should check the convergence information by viewing the generated *log* file which shows the number of iterations and the initial and final residuals of the displacement in each direction being solved. The final residual should always be less than 0.9 times the initial residual as this iteration tolerance set. Once both initial residuals have dropped below the convergence tolerance of  $10^{-6}$  the run has converged and can be stopped by killing the batch job.

## 2.2.3 Post-processing

Post processing can be performed as in [section 2.1.4](#). The `solidDisplacementFoam` solver outputs the stress field  $\sigma$  as a symmetric tensor field `sigma`. This is consistent with the way variables are usually represented in OpenFOAM solvers by the mathematical symbol by which they are represented; in the case of Greek symbols, the variable is named phonetically.

For post-processing individual scalar field components,  $\sigma_{xx}$ ,  $\sigma_{yy}$  etc., can be generated by running the `foamCalc` utility as before in [section 2.1.5.7](#), this time on `sigma`:

```
foamCalc components sigma
```

Components named `sigmaxx`, `sigmaxy` etc. are written to time directories of the case. The  $\sigma_{xx}$  stresses can be viewed in `paraFoam` as shown in [Figure 2.18](#).

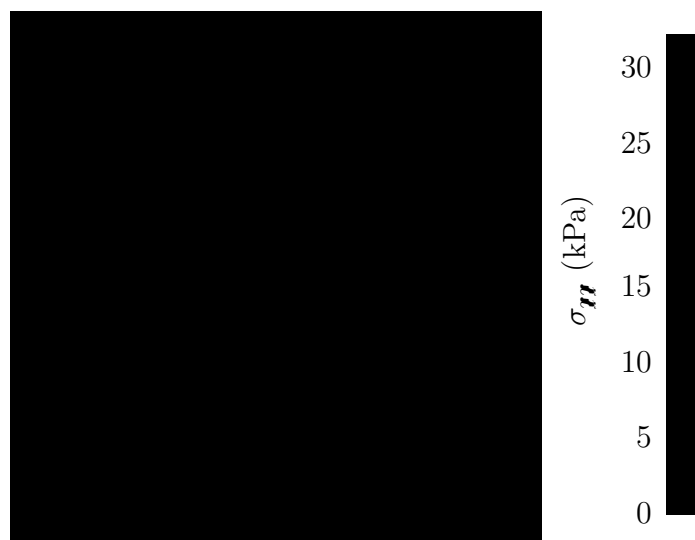
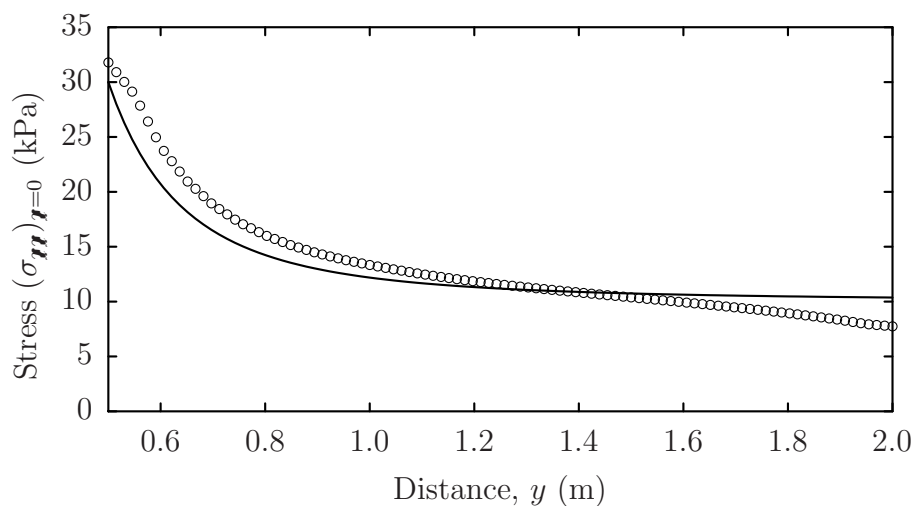

Figure 2.18:  $\sigma_{xx}$  stress field in the plate with hole.

We would like to compare the analytical solution of [Equation 2.14](#) to our solution. We therefore must output a set of data of  $\sigma_{xx}$  along the left edge symmetry plane of our domain. The user may generate the required graph data using the `sample` utility. The utility uses a `sampleDict` dictionary located in the `system` directory, whose entries are summarised in [Table 6.3](#). The sample line specified in `sets` is set between (0.0, 0.5, 0.25) and (0.0, 2.0, 0.25), and the fields are specified in the `fields` list:



Numerical prediction    ○            Analytical solution    —

Figure 2.19: Normal stress along the vertical symmetry  $(\sigma_{xx})_{y=0}$

```

17
18 interpolationScheme cellPoint;
19
20 setFormat      raw;
21
22 sets
23 (
24     leftPatch
25     {
26         type      uniform;
27         axis      y;
28         start     ( 0 0.5 0.25 );
29         end       ( 0 2 0.25 );
30         nPoints   100;
31     }
32 );
33
34 surfaces      ();
35
36 fields       ( sigmaxx );
37
38
39 // ***** //

```

The user should execute `sample` as normal. The `writeFormat` is `raw` 2 column format. The data is written into files within time subdirectories of a `sets` directory, *e.g.* the data at  $t = 100$  s is found within the file `sets/100/leftPatch_sigmaxx.xy`. In an application such as `GnuPlot`, one could type the following at the command prompt would be sufficient to plot both the numerical data and analytical solution:

```

plot [0.5:2] [0:] 'sets/100/leftPatch_sigmaxx.xy',
1e4*(1+(0.125/(x**2))+(0.09375/(x**4)))

```

An example plot is shown in [Figure 2.19](#).

## 2.2.4 Exercises

The user may wish to experiment with `solidDisplacementFoam` by trying the following exercises:

### 2.2.4.1 Increasing mesh resolution

Increase the mesh resolution in each of the  $x$  and  $y$  directions. Use `mapFields` to map the final coarse mesh results from [section 2.2.3](#) to the initial conditions for the fine mesh.

### 2.2.4.2 Introducing mesh grading

Grade the mesh so that the cells near the hole are finer than those away from the hole. Design the mesh so that the ratio of sizes between adjacent cells is no more than 1.1 and so that the ratio of cell sizes between blocks is similar to the ratios within blocks. Mesh grading is described in [section 2.1.6](#). Again use `mapFields` to map the final coarse mesh results from [section 2.2.3](#) to the initial conditions for the graded mesh. Compare the results with those from the analytical solution and previous calculations. Can this solution be improved upon using the same number of cells with a different solution?

### 2.2.4.3 Changing the plate size

The analytical solution is for an infinitely large plate with a finite sized hole in it. Therefore this solution is not completely accurate for a finite sized plate. To estimate the error, increase the plate size while maintaining the hole size at the same value.

## 2.3 Breaking of a dam

In this tutorial we shall solve a problem of simplified dam break in 2 dimensions using the `interFoam`. The feature of the problem is a transient flow of two fluids separated by a sharp interface, or free surface. The two-phase algorithm in `interFoam` is based on the volume of fluid (VOF) method in which a specie transport equation is used to determine the relative volume fraction of the two phases, or phase fraction  $\alpha_1$ , in each computational cell. Physical properties are calculated as weighted averages based on this fraction. The nature of the VOF method means that an interface between the species is not explicitly computed, but rather emerges as a property of the phase fraction field. Since the phase fraction can have any value between 0 and 1, the interface is never sharply defined, but occupies a volume around the region where a sharp interface should exist.

The test setup consists of a column of water at rest located behind a membrane on the left side of a tank. At time  $t = 0$  s, the membrane is removed and the column of water collapses. During the collapse, the water impacts an obstacle at the bottom of the tank and creates a complicated flow structure, including several captured pockets of air. The geometry and the initial setup is shown in [Figure 2.20](#).

### 2.3.1 Mesh generation

The user should go to the `damBreak` case in their `$FOAM_RUN/tutorials/multiphase/interFoam/laminar` directory. Generate the mesh running `blockMesh` as described previously. The `damBreak` mesh consist of 5 blocks; the `blockMeshDict` entries are given below.

```

17  convertToMeters 0.146;
18
19  vertices
20  (
21      (0 0 0)
22      (2 0 0)
23      (2.16438 0 0)
24      (4 0 0)
25      (0 0.32876 0)
26      (2 0.32876 0)
27      (2.16438 0.32876 0)
28      (4 0.32876 0)
29      (0 4 0)
30      (2 4 0)
31      (2.16438 4 0)
32      (4 4 0)
33      (0 0 0.1)
34      (2 0 0.1)
35      (2.16438 0 0.1)

```



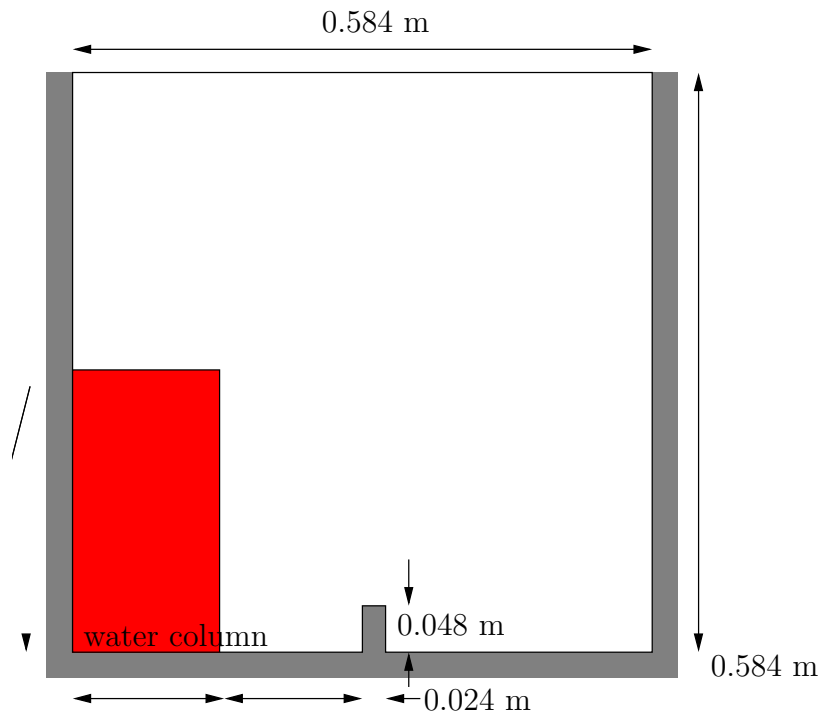

Figure 2.20: Geometry of the dam break.

0.292 m

```

36     (4 00.1)
37     (0 0.32876 0.1)
38     (2 0.32876 0.1)
39     (2.16438 0.32876 0.1)
40     (4 0.32876 0.1)
41     (0 40.1)
42     (2 40.1)    0.1461 m  0.1459 m
43     (2.16438 40.1)
44     (4 40.1)
45 );
46
47 blocks
48 (
49     hex (01 5412 131716) (23 81) simpleGrading (111)
50     hex (23 7614 151918) (19 81) simpleGrading (111)
51     hex (45 9816 172120) (23 421) simpleGrading (111)
52     hex (56 10917 1822 21) (4 421) simpleGrading (111)
53     hex (67 111018 1923 22) (19 421) simpleGrading (11 1)
54 );
55
56 edges
57 (
58 );
59
60 patches
61 (
62     wall leftWall
63     (
64         (012 164)
65         (416 208)
66     )
67     wall rightWall
68     (
69         (719 153)
70         (1123 197)
71     )
72     wall lowerWall
73     (
74         (01 1312)
75         (15 1713)
76         (56 1817)
77         (214 186)
78         (23 1514)
79     )
80     patch atmosphere
81     (
82         (820 219)

```

```

83         (9 21 22 10)
84         (10 22 23 11)
85     )
86 );
87
88 mergePatchPairs
89 (
90 );
91
92 // ***** //

```

## 2.3.2 Boundary conditions

The user can examine the boundary geometry generated by `blockMesh` by viewing the `boundary` file in the `constant/polyMesh` directory. The file contains a list of 5 boundary patches: `leftWall`, `rightWall`, `lowerWall`, `atmosphere` and `defaultFaces`. The user should notice the type of the patches. The `atmosphere` is a standard `patch`, *i.e.* has no special attributes, merely an entity on which boundary conditions can be specified. The `defaultFaces` patch is `empty` since the patch normal is in the direction we will not solve in this 2D case. The `leftWall`, `rightWall` and `lowerWall` patches are each a `wall`. Like the plain `patch`, the `wall` type contains no geometric or topological information about the mesh and only differs from the plain `patch` in that it identifies the patch as a wall, should an application need to know, *e.g.* to apply special wall surface modelling.

A good example is that the `interFoam` solver includes modelling of surface tension at the contact point between the interface and wall surface. The models are applied by specifying the `alphaContactAngle` boundary condition on the `alpha1` ( $\alpha_1$ ) field. With it, the user must specify the following: a static contact angle, `theta0`  $\theta_0$ ; leading and trailing edge dynamic contact angles, `thetaA`  $\theta_A$  and `thetaR`  $\theta_R$  respectively; and a velocity scaling function for dynamic contact angle, `uTheta`.

In this tutorial we would like to ignore surface tension effects between the wall and interface. We can do this by setting the static contact angle,  $\theta_0 = 90^\circ$  and the velocity scaling function to 0. However, the simpler option which we shall choose here is to specify a `zeroGradient` type on `alpha1`, rather than use the `alphaContactAngle` boundary condition.

The `top` boundary is free to the atmosphere and so is given an `atmosphere` boundary type; the `defaultFaces` representing the front and back planes of the 2D problem, is, as usual, an `empty` type.

## 2.3.3 Setting initial field

Unlike the previous cases, we shall now specify a non-uniform initial condition for the phase fraction  $\alpha_1$  where

$$\alpha_1 = \begin{cases} 1 & \text{for the liquid phase} \\ 0 & \text{for the gas phase} \end{cases} \quad (2.15)$$

This will be done by running the `setFields` utility. It requires a `setFieldsDict` dictionary, located in the `system` directory, whose entries for this case are shown below.

```

17
18 defaultFieldValues
19 (
20     volScalarFieldValue alpha1 0
21 );
22
23 regions
24 (
25     boxToCell
26     {
27         box (0 0 -1) (0.1461 0.292 1);
28         fieldValues

```

```

29         (
30             volScalarFieldValue alpha1 1
31         );
32     }
33 );
34
35
36 // ***** //

```

The `defaultFieldValues` sets the default value of the fields, *i.e.* the value the field takes unless specified otherwise in the `regions` sub-dictionary. That sub-dictionary contains a list of subdictionaries containing `fieldValues` that override the defaults in a specified region. The region is expressed in terms of a `topoSetSource` that creates a set of points, cells or faces based on some topological constraint. Here, `boxToCell` creates a bounding box within a vector minimum and maximum to define the set of cells of the liquid region. The phase fraction  $\alpha_1$  is defined as 1 in this region.

The user should execute `setFields` as any other utility is executed. Using `paraFoam`, check that the initial `alpha1` field corresponds to the desired distribution as in [Figure 2.21](#).

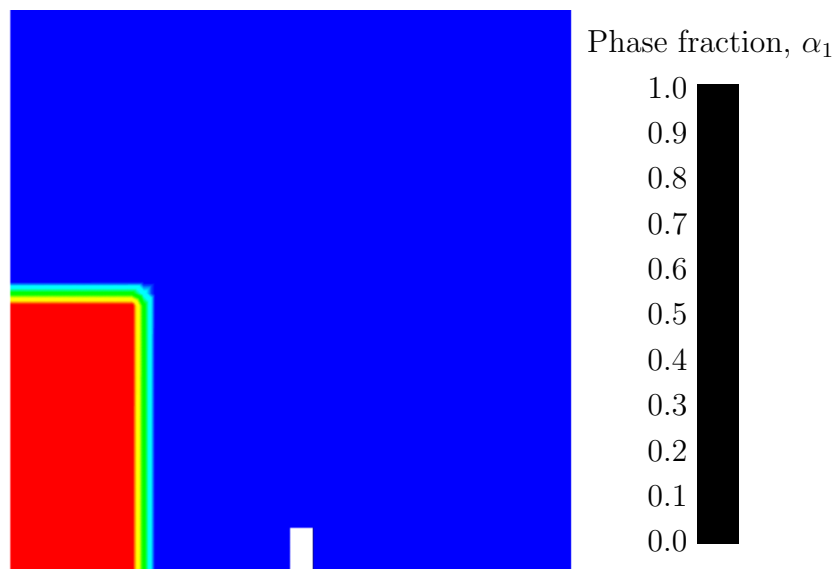

Figure 2.21: Initial conditions for phase fraction  $\alpha_1$ .

### 2.3.4 Fluid properties

Let us examine the `transportProperties` file in the `constant` directory. It dictionary contains the material properties for each fluid, separated into two subdictionaries `phase1` and `phase2`. The transport model for each phase is selected by the `transportModel` keyword. The user should select `Newtonian` in which case the kinematic viscosity is single valued and specified under the keyword `nu`. The viscosity parameters for the other models, *e.g.* `CrossPowerLaw`, are specified within subdictionaries with the generic name `<model>Coeffs`, *i.e.* `CrossPowerLawCoeffs` in this example. The density is specified under the keyword `rho`.

The surface tension between the two phases is specified under the keyword `sigma`. The values used in this tutorial are listed in [Table 2.3](#).

Gravitational acceleration is uniform across the domain and is specified in a file named `g` in the `constant` directory. Unlike a normal field file, *e.g.* `U` and `p`, `g` is a `uniformDimensionedVectorField` and so simply contains a set of `dimensions` and a `value` that represents  $(0, 9.81, 0) \text{ m s}^{-2}$  for this tutorial:

phase1 properties			
Kinematic viscosity	$\text{m}^2 \text{s}^{-1}$	<code>nu</code>	$1.0 \times 10^{-6}$
Density	$\text{kg m}^{-3}$	<code>rho</code>	$1.0 \times 10^3$
phase2 properties			
Kinematic viscosity	$\text{m}^2 \text{s}^{-1}$	<code>nu</code>	$1.48 \times 10^{-5}$
Density	$\text{kg m}^{-3}$	<code>rho</code>	1.0
Properties of both phases			
Surface tension	$\text{N m}^{-1}$	<code>sigma</code>	0.07

Table 2.3: Fluid properties for the `damBreak` tutorial

```

17
18 dimensions      [0 1 -2 0 0 0 0];
19 value          ( 0 -9.81 0 );
20
21
22 // ***** //

```

### 2.3.5 Turbulence modelling

As in the cavity example, the choice of turbulence modelling method is selectable at run-time through the `simulationType` keyword in `turbulenceProperties` dictionary. In this example, we wish to run without turbulence modelling so we set `laminar`:

```

17
18 simulationType  laminar;
19
20
21 // ***** //

```

### 2.3.6 Time step control

Time step control is an important issue in free surface tracking since the surface-tracking algorithm is considerably more sensitive to the Courant number  $Co$  than in standard fluid flow calculations. Ideally, we should not exceed an upper limit  $Co \approx 0.5$  in the region of the interface. In some cases, where the propagation velocity is easy to predict, the user should specify a fixed time-step to satisfy the  $Co$  criterion. For more complex cases, this is considerably more difficult. `interFoam` therefore offers automatic adjustment of the time step as standard in the `controlDict`. The user should specify `adjustTimeStep` to be `on` and the the maximum  $Co$ , `maxCo` to be 0.5. The upper limit on time step `maxDeltaT` can be set to a value that will not be exceeded in this simulation, *e.g.* 1.0.

By using automatic time step control, the steps themselves are never rounded to a convenient value. Consequently if we request that OpenFOAM saves results at a fixed number of time step intervals, the times at which results are saved are somewhat arbitrary. However even with automatic time step adjustment, OpenFOAM allows the user to specify that results are written at fixed times; in this case OpenFOAM forces the automatic time stepping procedure to adjust time steps so that it ‘hits’ on the exact times specified for write output. The user selects this with the `adjustableRunTime` option for `writeControl` in the `controlDict` dictionary. The `controlDict` dictionary entries should be:

```

17
18 application    interFoam;
19
20 startFrom      startTime;
21

```

```

22  startTime      0;
23
24  stopAt         endTime;
25
26  endTime        1;
27
28  deltaT         0.001;
29
30  writeControl   adjustableRunTime;
31
32  writeInterval  0.05;
33
34  purgeWrite     0;
35
36  writeFormat    ascii;
37
38  writePrecision 6;
39
40  writeCompression uncompressed;
41
42  timeFormat     general;
43
44  timePrecision  6;
45
46  runTimeModifiable yes;
47
48  adjustTimeStep yes;
49
50  maxCo          0.5;
51
52  maxDeltaT      1;
53
54
55  // ***** //

```

### 2.3.7 Discretisation schemes

The free surface treatment in OpenFOAM does not account for the effects of turbulence. This is a consequence of the fact that the Reynolds averaged approach to turbulence modelling does not match the notion of an infinitesimally thin interface between air and water. As a consequence, all free surface simulations can be viewed as a direct numerical simulation (DNS) of fluid flow. DNS is associated with certain requirements on the mesh size, far beyond the mesh resolution of our test case.

This solver uses the multidimensional universal limiter for explicit solution (MULES) method, created by OpenCFD, to maintain boundedness of the phase fraction independent of underlying numerical scheme, mesh structure, *etc.* The choice of schemes for convection are therefore not restricted to those that are strongly stable or bounded, *e.g.* upwind differencing.

The convection schemes settings are made in the *divSchemes* sub-dictionary of the *fvSchemes* dictionary. In this example, the convection term in the momentum equation ( $\nabla \cdot (\rho \mathbf{U} \mathbf{U})$ ), denoted by the `div(rho*phi,U)` keyword, uses `Gauss limitedLinearV 1.0` to produce good accuracy. The limited linear schemes require a coefficient  $\phi$  as described in [section 4.4.1](#). Here, we have opted for best stability with  $\phi = 1.0$ . The  $\nabla \cdot (\mathbf{U} \alpha_1)$  term, represented by the `div(phi,alpha)` keyword uses the `vanLeer` scheme. The  $\nabla \cdot (\mathbf{U}_{r\theta} \alpha_1)$  term, represeniv(

```

25     default      Gauss linear;
26     grad(U)      Gauss linear;
27     grad(alpha1) Gauss linear;
28 }
29
30 divSchemes
31 {
32     div(rho*phi,U) Gauss limitedLinearV 1;
33     div(phi,alpha) Gauss vanLeer;
34     div(phi*rb,alpha) Gauss interfaceCompression;
35 }
36
37 laplacianSchemes
38 {
39     default      Gauss linear corrected;
40 }
41
42 interpolationSchemes
43 {
44     default      linear;
45 }
46
47 snGradSchemes
48 {
49     default      corrected;
50 }
51
52 fluxRequired
53 {
54     default      no;
55     p;
56     pcorr;
57     alpha1;
58 }
59
60
61 // ***** //

```

### 2.3.8 Linear-solver control

In the *fvSolution*, the *PISO* sub-dictionary contains elements that are specific to *interFoam*. There are the usual correctors to the momentum equation but also correctors to a PISO loop around the  $\alpha_1$  phase equation. Of particular interest are the `nAlphaSubCycles` and `cAlpha` keywords. `nAlphaSubCycles` represents the number of sub-cycles within the  $\alpha_1$  equation; sub-cycles are additional solutions to an equation within a given time step. It is used to enable the solution to be stable without reducing the time step and vastly increasing the solution time. Here we specify 2 sub-cycles, which means that the  $\alpha_1$  equation is solved in  $2\times$  half length time steps within each actual time step.

The `cAlpha` keyword is a factor that controls the compression of the interface where: 0 corresponds to no compression; 1 corresponds to conservative compression; and, anything larger than 1, relates to enhanced compression of the interface. We generally recommend a value of 1.0 which is employed in this example.

### 2.3.9 Running the code

Running of the code has been described in detail in previous tutorials. Try the following, that uses `tee`, a command that enables output to be written to both standard output and files:

```

cd $FOAM_RUN/tutorials/multiphase/interFoam/laminar/damBreak
interFoam | tee log

```

The code will now be run interactively, with a copy of output stored in the *log* file.

### 2.3.10 Post-processing

Post-processing of the results can now be done in the usual way. The user can monitor the development of the phase fraction `alpha1` in time; [Figure 2.22](#).

### 2.3.11 Running in parallel

The results from the previous example are generated using a fairly coarse mesh. We now wish to increase the mesh resolution and re-run the case. The new case will typically take a few hours to run with a single processor so, should the user have access to multiple processors, we can demonstrate the parallel processing capability of OpenFOAM.

The user should first make a copy of the `damBreak` case, *e.g.* by

```
cd $FOAM_RUN/tutorials/multiphase/interFoam/laminar
mkdir damBreakFine
cp -r damBreak/0 damBreakFine
cp -r damBreak/system damBreakFine
cp -r damBreak/constant damBreakFine
```

Enter the new case directory and change the `blocks` description in the `blockMeshDict` dictionary to

```
blocks
(
  hex (0 1 5 4 12 13 17 16) (46 10 1) simpleGrading (1 1 1)
  hex (2 3 7 6 14 15 19 18) (40 10 1) simpleGrading (1 1 1)
  hex (4 5 9 8 16 17 21 20) (46 76 1) simpleGrading (1 2 1)
  hex (5 6 10 9 17 18 22 21) (4 76 1) simpleGrading (1 2 1)
  hex (6 7 11 10 18 19 23 22) (40 76 1) simpleGrading (1 2 1)
);
```

Here, the entry is presented as printed from the `blockMeshDict` file; in short the user must change the mesh densities, *e.g.* the `46 10 1` entry, and some of the mesh grading entries to `1 2 1`. Once the dictionary is correct, generate the mesh.

As the mesh has now changed from the `damBreak` example, the user must re-initialise the phase field `alpha1` in the `0` time directory since it contains a number of elements that is inconsistent with the new mesh. Note that there is no need to change the `U` and `p` fields since they are specified as `uniform` which is independent of the number of elements

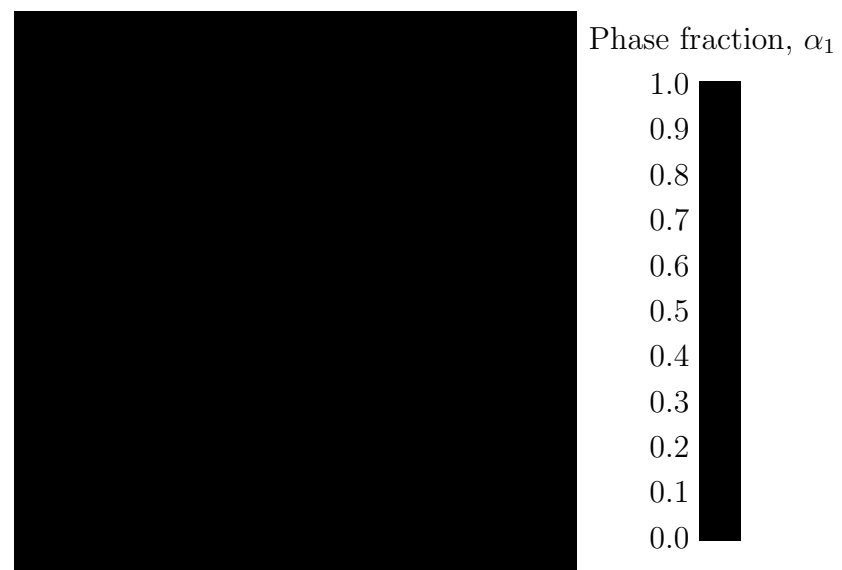
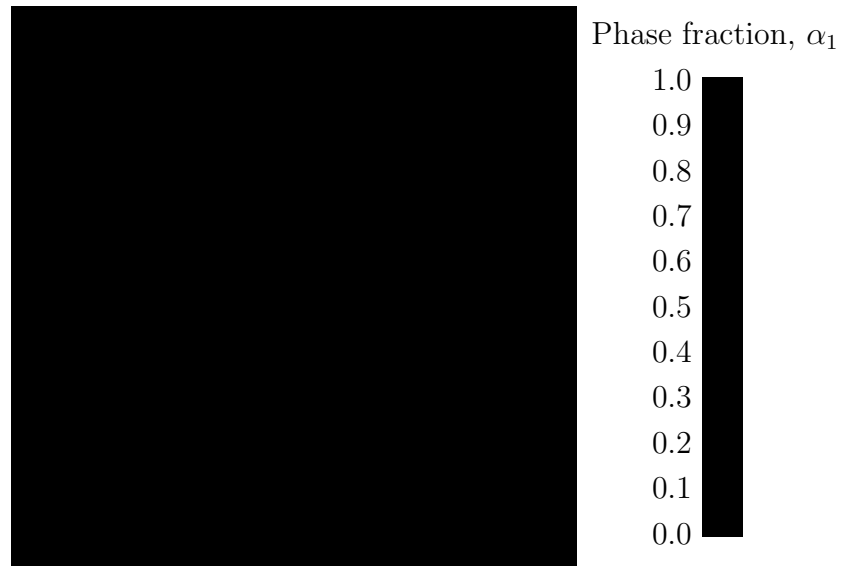

Figure 2.22: Snapshots of phase  $\alpha_1$ .



case is therefore to decompose the domain using the `decomposePar` utility. There is a dictionary associated with `decomposePar` named `decomposeParDict` which is located in the `system` directory of the tutorial case; also, like with many utilities, a default dictionary can be found in the directory of the source code of the specific utility, *i.e.* in `$FOAM_UTILITIES/parallelProcessing/decomposePar` for this case.

The first entry is `numberOfSubdomains` which specifies the number of subdomains into which the case will be decomposed, usually corresponding to the number of processors available for the case.

In this tutorial, the `method` of decomposition should be `simple` and the corresponding `simpleCoeffs` should be edited according to the following criteria. The domain is split into pieces, or subdomains, in the  $x$ ,  $y$  and  $z$  directions, the number of subdomains in each direction being given by the vector  $\mathbf{n}$ . As this geometry is 2 dimensional, the 3rd direction,  $z$ , cannot be split, hence  $n_z$  must equal 1. The  $n_x$  and  $n_y$  components of  $\mathbf{n}$  split the domain in the  $x$  and  $y$  directions and must be specified so that the number of subdomains specified by  $n_x$  and  $n_y$  equals the specified `numberOfSubdomains`, *i.e.*  $n_x n_y = \text{numberOfSubdomains}$ . It is beneficial to keep the number of cell faces adjoining the subdomains to a minimum so, for a square geometry, it is best to keep the split between the  $x$  and  $y$  directions should be fairly even. The `delta` keyword should be set to 0.001.

For example, let us assume we wish to run on 4 processors. We would set `numberOfSubdomains` to 4 and  $\mathbf{n} = (2, 2, 1)$ . When running `decomposePar`, we can see from the screen messages that the decomposition is distributed fairly even between the processors.

The user should consult [section 3.4](#) for details of how to run a case in parallel; in this tutorial we merely present an example of running in parallel. We use the `openMPI` implementation of the standard message-passing interface (MPI). As a test here, the user can run in parallel on a single node, the local host only, by typing:

```
mpirun -np 4 interFoam -parallel > log &
```

The user may run on more nodes over a network by creating a file that lists the host names of the machines on which the case is to be run as described in [section 3.4.2](#). The case should run in the background and the user can follow its progress by monitoring the `log` file as usual.

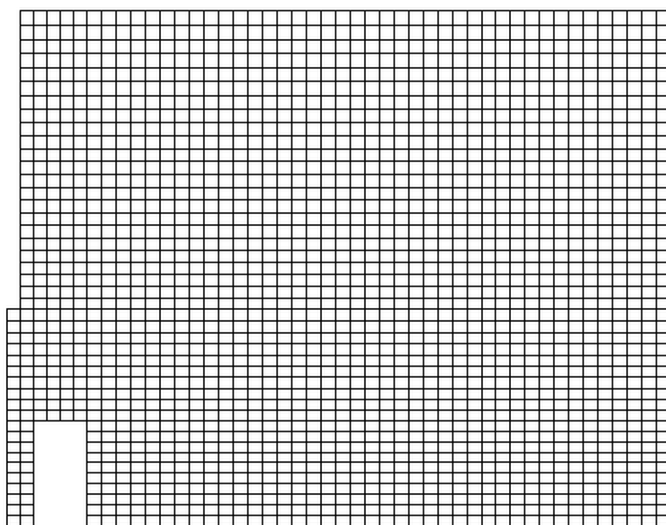

Figure 2.23: Mesh of processor 2 in parallel processed case.

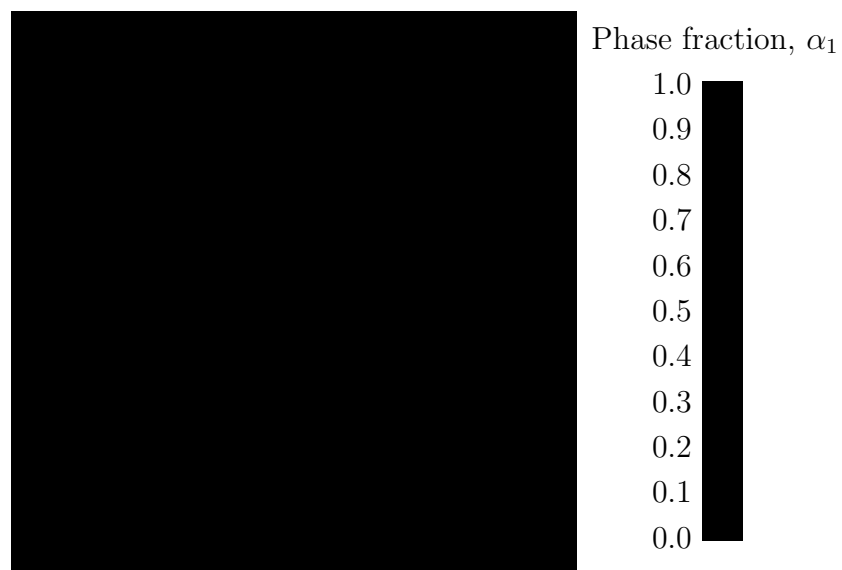
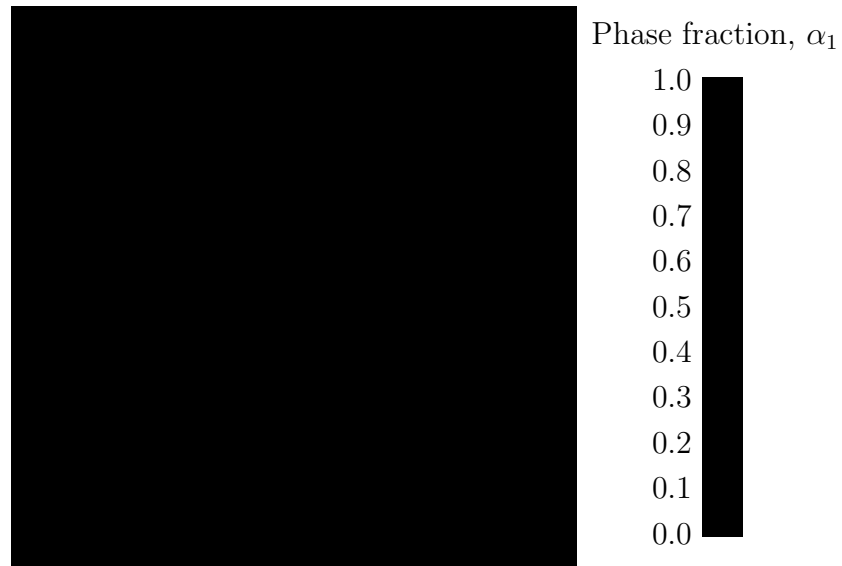

Figure 2.24: Snapshots of phase  $\alpha_1$  with refined mesh.

### 2.3.12 Post-processing a case run in parallel

Once the case has completed running, the decomposed fields and mesh must be reassembled for post-processing using the `reconstructPar` utility. Simply execute it from the command line. The results from the fine mesh are shown in [Figure 2.24](#). The user can see that the resolution of interface has improved significantly compared to the coarse mesh.

The user may also post-process a segment of the decomposed domain individually by simply treating the individual processor directory as a case in its own right. For example if the user starts `paraFoam` by

```
paraFoam -case processor1
```

then `processor1` will appear as a case module in ParaView. [Figure 2.23](#) shows the mesh from processor 1 following the decomposition of the domain using the `simple` method.



# Chapter 3

## Applications and libraries

We should reiterate from the outset that OpenFOAM is a C++ library used primarily to create executables, known as *applications*. OpenFOAM is distributed with a large set of precompiled applications but users also have the freedom to create their own or modify existing ones. Applications are split into two main categories:

**solvers** that are each designed to solve a specific problem in computational continuum mechanics;

**utilities** that perform simple pre-and post-processing tasks, mainly involving data manipulation and algebraic calculations.

OpenFOAM is divided into a set of precompiled libraries that are dynamically linked during compilation of the solvers and utilities. Libraries such as those for physical models are supplied as source code so that users may conveniently add their own models to the libraries.

This chapter gives an overview of solvers, utilities and libraries, their creation, modification, compilation and execution. The actual writing of code for solvers and utilities is not described here but is within the Programmer's Guide. The Programmer's Guide is currently under development so, if users have any queries, further information may also be available at the [OpenFOAM web site](#).

### 3.1 The programming language of OpenFOAM

In order to understand the way in which the OpenFOAM library works, some background knowledge of C++, the base language of OpenFOAM, is required; the necessary information will be presented in this chapter. Before doing so, it is worthwhile addressing the concept of language in general terms to explain some of the ideas behind object-oriented programming and our choice of C++ as the main programming language of OpenFOAM.

#### 3.1.1 Language in general

The success of verbal language and mathematics is based on efficiency, especially in expressing abstract concepts. For example, in fluid flow, we use the term “velocity field”, which has meaning without any reference to the nature of the flow or any specific velocity data. The term encapsulates the idea of movement with direction and magnitude and relates to other physical properties. In mathematics, we can represent velocity field by a single symbol, *e.g.*  $\mathbf{U}$ , and express certain concepts using symbols, *e.g.* “the field of velocity magnitude” by  $|\mathbf{U}|$ . The advantage of mathematics over verbal language is its greater efficiency, making it possible to express complex concepts with extreme clarity.

The problems that we wish to solve in continuum mechanics are not presented in terms of intrinsic entities, or types, known to a computer, *e.g.* bits, bytes, integers. They are usually presented first in verbal language, then as partial differential equations in 3 dimensions of space and time. The equations contain the following concepts: scalars, vectors, tensors, and fields thereof; tensor algebra; tensor calculus; dimensional units. The solution to these equations involves discretisation procedures, matrices, solvers, and solution algorithms. The topics of tensor mathematics and numerics are the subjects of [chapter 1](#) and [chapter 2](#) of the Programmer’s Guide.

### 3.1.2 Object-orientation and C++

Programming languages that are object-oriented, such as C++, provide the mechanism — *classes* — to declare types and associated operations that are part of the verbal and mathematical languages used in science and engineering. Our velocity field introduced earlier can be represented in programming code by the symbol  $\mathbf{U}$  and “the field of velocity magnitude” can be `mag(U)`. The velocity is a vector field for which there should exist, in an object-oriented code, a `vectorField` class. The velocity field  $\mathbf{U}$  would then be an instance, or *object*, of the `vectorField` class; hence the term object-oriented.

The clarity of having objects in programming that represent physical objects and abstract entities should not be underestimated. The class structure concentrates code development to contained regions of the code, *i.e.* the classes themselves, thereby making the code easier to manage. New classes can be derived or inherit properties from other classes, *e.g.* the `vectorField` can be derived from a `vector` class and a `Field` class. C++ provides the mechanism of *template classes* such that the template class `Field<Type>` can represent a field of any `<Type>`, *e.g.* `scalar`, `vector`, `tensor`. The general features of the template class are passed on to any class created from the template. Templating and inheritance reduce duplication of code and create class hierarchies that impose an overall structure on the code.

### 3.1.3 Equation representation

A central theme of the OpenFOAM design is that the solver applications, written using the OpenFOAM classes, have a syntax that closely resembles the partial differential equations being solved. For example the equation

$$\frac{\partial \rho \mathbf{U}}{\partial t} + \nabla \cdot \phi \mathbf{U} - \nabla \cdot \mu \nabla \mathbf{U} = -\nabla p$$

is represented by the code

```

solve
(
    fvm::ddt(rho, U)
  + fvm::div(phi, U)
  - fvm::laplacian(mu, U)
  ==
  - fvc::grad(p)
);

```

This and other requirements demand that the principal programming language of OpenFOAM has object-oriented features such as inheritance, template classes, virtual functions



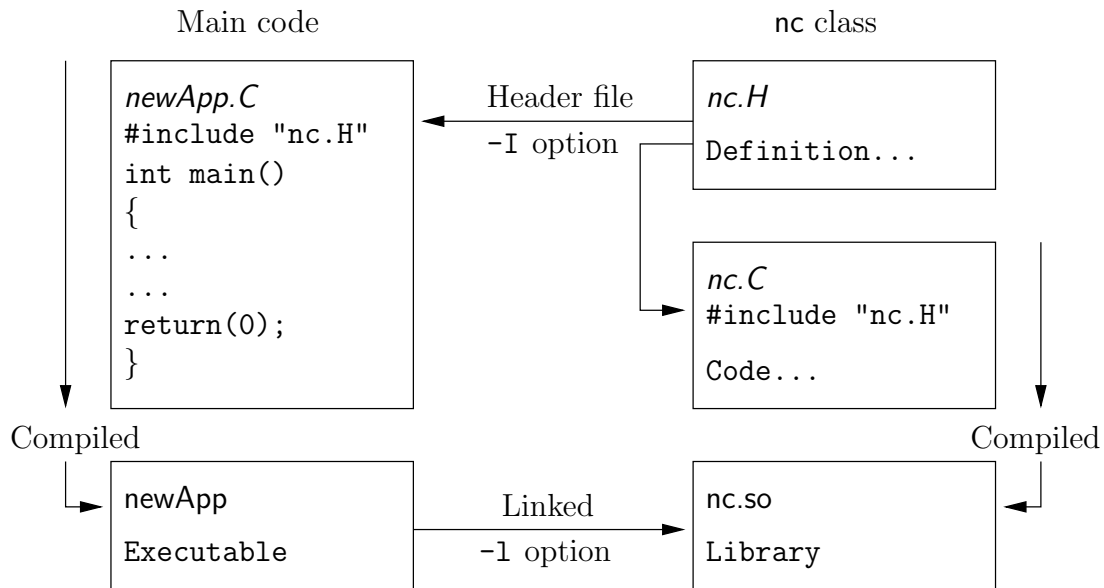

Figure 3.1: Header files, source files, compilation and linking.

of header files for all the classes on which the top level `.C` code ultimately depends; these `.H` files are known as the *dependencies*. With a dependency list, a compiler can check whether the source files have been updated since their last compilation and selectively compile only those that need to be.

Header files are included in the code using `# include` statements, *e.g.*

```
# include "otherHeader.H";
```

causes the compiler to suspend reading from the current file to read the file specified. Any self-contained piece of code can be put into a header file and included at the relevant location in the main code in order to improve code readability. For example, in most OpenFOAM applications the code for creating fields and reading field input data is included in a file `createFields.H` which is called at the beginning of the code. In this way, header files are not solely used as class declarations. It is `wmake` that performs the task of maintaining file dependency lists amongst other functions listed below.

- Automatic generation and maintenance of file dependency lists, *i.e.* lists of files which are included in the source files and hence on which they depend.
- Multi-platform compilation and linkage, handled through appropriate directory structure.
- Multi-language compilation and linkage, *e.g.* C, C++, Java.
- Multi-option compilation and linkage, *e.g.* debug, optimised, parallel and profiling.
- Support for source code generation programs, *e.g.* lex, yacc, IDL, MOC.
- Simple syntax for source file lists.
- Automatic creation of source file lists for new codes.
- Simple handling of multiple shared or static libraries.
- Extensible to new machine types.



- Extremely portable, works on any machine with: `make`; `sh`, `ksh` or `csh`; `lex`, `cc`.
- Has been tested on Apollo, SUN, SGI, HP (HPUX), Compaq (DEC), IBM (AIX), Cray, Ardent, Stardent, PC Linux, PPC Linux, NEC, SX4, Fujitsu VP1000.

### 3.2.2 Compiling with wmake

OpenFOAM applications are organised using a standard convention that the source code of each application is placed in a directory whose name is that of the application. The top level source file takes the application name with the `.C` extension. For example, the source code for an application called `newApp` would reside in a directory `newApp` and the top level file would be `newApp.C` as shown in [Figure 3.2](#). The directory must also contain

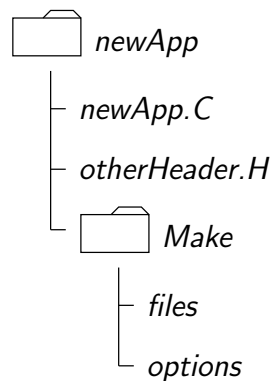

Figure 3.2: Directory structure for an application

a `Make` subdirectory containing 2 files, `options` and `files`, that are described in the following sections.

#### 3.2.2.1 Including headers

The compiler searches for the included header files in the following order, specified with the `-I` option in `wmake`:

1. the `$WM_PROJECT_DIR/src/OpenFOAM/InInclude` directory;
2. a local `InInclude` directory, *i.e.* `newApp/InInclude`;
3. the local directory, *i.e.* `newApp`;
4. platform dependent paths set in files in the `$WM_PROJECT_DIR/wmake/rules/$WM_ARCH/` directory, *e.g.* `/usr/X11/include` and `$(MPICH_ARCH_PATH)/include`;
5. other directories specified explicitly in the `Make/options` file with the `-I` option.

The `Make/options` file contains the full directory paths to locate header files using the syntax:

```

EXE_INC = \
  -I<directoryPath1> \
  -I<directoryPath2> \
  ... \
  -I<directoryPathN>
  
```

Notice first that the directory names are preceded by the `-I` flag and that the syntax uses the `\` to continue the `EXE_INC` across several lines, with no `\` after the final entry.

### 3.2.2.2 Linking to libraries

The compiler links to shared object library files in the following directory **paths**, specified with the `-L` option in `wmake`:

1. the `$FOAM_LIBBIN` directory;
2. platform dependent paths set in files in the `$WDM_DIR/rules/$WDM_ARCH/` directory, *e.g.* `/usr/X11/lib` and `$(MPICH_ARCH_PATH)/lib`;
3. other directories specified in the `Make/options` file.

The actual library **files** to be linked must be specified using the `-l` option and removing the `lib` prefix and `.so` extension from the library file name, *e.g.* `libnew.so` is included with the flag `-lnew`. By default, `wmake` loads the following libraries:

1. the `libOpenFOAM.so` library from the `$FOAM_LIBBIN` directory;
2. platform dependent libraries specified in set in files in the `$WDM_DIR/rules/$WDM_ARCH/` directory, *e.g.* `libm.so` from `/usr/X11/lib` and `liblam.so` from `$(LAM_ARCH_PATH)/lib`;
3. other libraries specified in the `Make/options` file.

The `Make/options` file contains the full directory paths and library names using the syntax:

```
EXE_LIBS = \
  -L<libraryPath1> \
  -L<libraryPath2> \
  ... \
  -L<libraryPathN> \
  -l<library1> \
  -l<library2> \
  ... \
  -l<libraryN>
```

Let us reiterate that the directory paths are preceded by the `-L` flag, the library names are preceded by the `-l` flag.

### 3.2.2.3 Source files to be compiled

The compiler requires a list of `.C` source files that must be compiled. The list must contain the main `.C` file but also any other source files that are created for the specific application but are not included in a class library. For example, users may create a new class or some new functionality to an existing class for a particular application. The full list of `.C` source files must be included in the `Make/files` file. As might be expected, for many applications the list only includes the name of the main `.C` file, *e.g.* `newApp.C` in the case of our earlier example.

The `Make/files` file also includes a full path and name of the compiled executable, specified by the `EXE =` syntax. Standard convention stipulates the name is that of the application, *i.e.* `newApp` in our example. The OpenFOAM release offers two useful choices for path: standard release applications are stored in `$FOAM_APPBIN`; applications developed by the user are stored in `$FOAM_USER_APPBIN`.

If the user is developing their own applications, we recommend they create an applications subdirectory in their `$WDM_PROJECT_USER_DIR` directory containing the source

code for personal OpenFOAM applications. As with standard applications, the source code for each OpenFOAM application should be stored within its own directory. The only difference between a user application and one from the standard release is that the *Make/files* file should specify that the user's executables are written into their *\$FOAM-USER\_APPBIN* directory. The *Make/files* file for our example would appear as follows:

```
newApp.C

EXE = $(FOAM_USER_APPBIN)/newApp
```

### 3.2.2.4 Running wmake

The *wmake* script is executed by typing:

```
wmake <optionalArguments> <optionalDirectory>
```

The *<optionalDirectory>* is the directory path of the application that is being compiled. Typically, *wmake* is executed from within the directory of the application being compiled, in which case *<optionalDirectory>* can be omitted.

If a user wishes to build an application executable, then no *<optionalArguments>* are required. However *<optionalArguments>* may be specified for building libraries *etc.* as described in [Table 3.1](#).

Argument	Type of compilation
lib	Build a statically-linked library
libso	Build a dynamically-linked library
libo	Build a statically-linked object file library
jar	Build a JAVA archive
exe	Build an application independent of the specified project

Table 3.1: Optional compilation arguments to *wmake*.

### 3.2.2.5 wmake environment variables

For information, the environment variable settings used by *wmake* are listed in [Table 3.2](#).

## 3.2.3 Removing dependency lists: wclean and rmdepall

On execution, *wmake* builds a dependency list file with a *.dep* file extension, *e.g. newApp.dep* in our example, and a list of files in a *Make/\$WM\_OPTIONS* directory. If the user wishes to remove these files, perhaps after making code changes, the user can run the *wclean* script by typing:

```
wclean <optionalArguments> <optionalDirectory>
```

Again, the *<optionalDirectory>* is equal to *tmp136(01147034)0.0500324(d)-0.311937(.)-649.467(T)27.3*

Main paths	
<code>\$WM_PROJECT_INST_DIR</code>	Full path to installation directory, <i>e.g.</i> <code>\$HOME/OpenFOAM</code>
<code>\$WM_PROJECT</code>	Name of the project being compiled: OpenFOAM
<code>\$WM_PROJECT_VERSION</code>	Version of the project being compiled: 1.6
<code>\$WM_PROJECT_DIR</code>	Full path to locate binary executables of OpenFOAM release, <i>e.g.</i> <code>\$HOME/OpenFOAM/OpenFOAM-1.6</code>
<code>\$WM_PROJECT_USER_DIR</code>	Full path to locate binary executables of the user <i>e.g.</i> <code>\$HOME/OpenFOAM/\${USER}-1.6</code>
Other paths/settings	
<code>\$WM_ARCH</code>	Machine architecture: <code>cray decAlpha dec ibm linux linuxPPC sgi3 sgi32 sgi64 sgiN32 solaris sx4 t3d</code>
<code>\$WM_COMPILER</code>	Compiler being used: <code>Gcc3 - gcc 4.3.3, KAI - KAI</code>
<code>\$WM_COMPILER_DIR</code>	Compiler installation directory
<code>\$WM_COMPILER_BIN</code>	Compiler installation binaries <code>\$WM_COMPILER_BIN/bin</code>
<code>\$WM_COMPILER_LIB</code>	Compiler installation libraries <code>\$WM_COMPILER_BIN/lib</code>
<code>\$WM_COMPILE_OPTION</code>	Compilation option: <code>Debug - debugging, Opt</code> optimisation.
<code>\$WM_DIR</code>	Full path of the <code>wmake</code> directory
<code>\$WM_JAVAC_OPTION</code>	Compilation option for JAVA: <code>Debug - debugging, Opt</code> optimisation.
<code>\$WM_LINK_LANGUAGE</code>	Compiler used to link libraries and executables. In multi-language projects a <code>\$WM_LINK_LANGUAGE</code> is set to the primary language.
<code>\$WM_MPLIB</code>	Parallel communications library: <code>LAM, MPI, MPICH, PVM</code>
<code>\$WM_OPTIONS</code>	<code>= \$WM_ARCH\$WM_COMPILER... ...\$WM_COMPILE_OPTION\$WM_MPLIB</code> <i>e.g.</i> <code>linuxGcc3OptMPICH</code>
<code>\$WM_PROJECT_LANGUAGE</code>	Programming language of project, <i>e.g.</i> <code>c++</code>
<code>\$WM_SHELL</code>	Shell used for the <code>wmake</code> scripts <code>bash, csh, ksh, tcsh</code>

Table 3.2: Environment variable settings for `wmake`.

If a user wishes to remove the dependency files and files from the `Make` directory, then no `<optionalArguments>` are required. However if `lib` is specified in `<optionalArguments>` a local `InInclude` directory will be deleted also.

An additional script, `rmdepall` removes all dependency `.dep` files recursively down the directory tree from the point at which it is executed. This can be useful when updating OpenFOAM libraries.

### 3.2.4 Compilation example: the `isoFoam` application

The source code for application `isoFoam` is in the `$FOAM_APP/solvers/incompressible/isoFoam` directory and the top level source file is named `isoFoam.C`. The `isoFoam.C` source code is:

```

1  /*-----*
2  =====
3  \ \      /  F i e l d      |  OpenFOAM: The Open Source CFD Toolbox
4  \ \      /  O p e r a t i o n  |

```

```

5      \ \ /   A nd           | Copyright (C) 1991-2009 OpenCFD Ltd.
6      \ \ /   M anipulation |
7      -----
8  License
9      This file is part of OpenFOAM.
10
11     OpenFOAM is free software; you can redistribute it and/or modify it
12     under the terms of the GNU General Public License as published by the
13     Free Software Foundation; either version 2 of the License, or (at your
14     option) any later version.
15
16     OpenFOAM is distributed in the hope that it will be useful, but WITHOUT
17     ANY WARRANTY; without even the implied warranty of MERCHANTABILITY or
18     FITNESS FOR A PARTICULAR PURPOSE. See the GNU General Public License
19     for more details.
20
21     You should have received a copy of the GNU General Public License
22     along with OpenFOAM; if not, write to the Free Software Foundation,
23     Inc., 51 Franklin St, Fifth Floor, Boston, MA 02110-1301 USA
24
25  Application
26  pisoFoam
27
28  Description
29  Transient solver for incompressible flow.
30
31  Turbulence modelling is generic, i.e. laminar, RAS or LES may be selected.
32
33  \*-----*/
34
35  #include "fvCFD.H"
36  #include "singlePhaseTransportModel.H"
37  #include "turbulenceModel.H"
38
39  // * * * * *
40
41  int main(int argc, char *argv[])
42  {
43      #include "setRootCase.H"
44
45      #include "createTime.H"
46      #include "createMesh.H"
47      #include "createFields.H"
48      #include "initContinuityErrs.H"
49
50      // * * * * *
51
52      Info<< "\nStarting time loop\n" << endl;
53
54      while (runTime.loop())
55      {
56          Info<< "Time = " << runTime.timeName() << nl << endl;
57
58          #include "readPISOControls.H"
59          #include "CourantNo.H"
60
61          // Pressure-velocity PISO corrector
62          {
63              // Momentum predictor
64
65              fvVectorMatrix UEqn
66              (
67                  fvm::ddt(U)
68                  + fvm::div(phi, U)
69                  + turbulence->divDevReff(U)
70              );
71
72              UEqn.relax();
73
74              if (momentumPredictor)
75              {
76                  solve(UEqn == -fvc::grad(p));
77              }
78
79              // --- PISO loop
80
81              for (int corr=0; corr<nCorr; corr++)
82              {
83                  volScalarField rUA = 1.0/UEqn.A();
84
85                  U = rUA*UEqn.H();
86                  phi = (fvc::interpolate(U) & mesh.Sf())
87                      + fvc::ddtPhiCorr(rUA, U, phi);
88

```

```

89         adjustPhi(phi, U, p);
90
91         // Non-orthogonal pressure corrector loop
92         for (int nonOrth=0; nonOrth<=nNonOrthCorr; nonOrth++)
93         {
94             // Pressure corrector
95
96             fvScalarMatrix pEqn
97             (
98                 fvm::laplacian(rUA, p) == fvc::div(phi)
99             );
100
101             pEqn.setReference(pRefCell, pRefValue);
102
103             if
104             (
105                 corr == nCorr-1
106                 && nonOrth == nNonOrthCorr
107             )
108             {
109                 pEqn.solve(mesh.solver("pFinal"));
110             }
111             else
112             {
113                 pEqn.solve();
114             }
115
116             if (nonOrth == nNonOrthCorr)
117             {
118                 phi -= pEqn.flux();
119             }
120         }
121
122         #include "continuityErrs.H"
123
124         U -= rUA*fvc::grad(p);
125         U.correctBoundaryConditions();
126     }
127 }
128
129 turbulence->correct();
130
131 runTime.write();
132
133 Info<< "ExecutionTime = " << runTime.elapsedCpuTime() << " s"
134         << " ClockTime = " << runTime.elapsedClockTime() << " s"
135         << nl << endl;
136 }
137
138 Info<< "End\n" << endl;
139
140 return 0;
141 }
142
143 // *****
144 // *****

```

The code begins with a brief description of the application contained within comments over 1 line (`//`) and multiple lines (`/*...*/`). Following that, the code contains several `# include` statements, *e.g.* `# include "fvCFD.H"`, which causes the compiler to suspend reading from the current file,  *pisoFoam.C*  to read the  *fvCFD.H* .

*pisoFoam*  resources the  *cfdTools* ,  *incompressibleRASModels*  and  *incompressibleTransportModels*  libraries and therefore requires the necessary header files, specified by the `EXE_INC = -I...` option, and links to the libraries with the `EXE_LIBS = -l...` option. The  *Make/options*  therefore contains the following:

```

1  EXE_INC = \
2  -I$(LIB_SRC)/turbulenceModels/incompressible/turbulenceModel \
3  -I$(LIB_SRC)/transportModels \
4  -I$(LIB_SRC)/transportModels/incompressible/singlePhaseTransportModel \
5  -I$(LIB_SRC)/finiteVolume/lnInclude
6
7  EXE_LIBS = \
8  -lincompressibleRASModels \
9  -lincompressibleLESModels \
10 -lincompressibleTransportModels \
11 -lfiniteVolume \
12 -lmeshTools

```

`pisofFoam` contains only the `pisofFoam.C` source and the executable is written to the `$FOAM_APPBIN` directory as all standard applications are. The `Make/files` therefore contains:

```
1  pisofFoam.C
2
3  EXE = $(FOAM_APPBIN)/pisofFoam
```

The user can compile `pisofFoam` by going to the `$FOAM_CFD/pisofFoam` directory and typing:

```
wmake
```

The code should compile and produce a message similar to the following

```
Making dependency list for source file pisofFoam.C

SOURCE_DIR=.
SOURCE=pisofFoam.C ;
g++ -DFOAM_EXCEPTION -Dlinux -DlinuxOptMPICH
-DscalarMachine -DoptSolvers -DPARALLEL -DUSEMPI -Wall -O2 -DNoRepository
-ftemplate-depth-17 -I.../OpenFOAM/OpenFOAM-1.6/src/OpenFOAM/lnInclude
-IlnInclude
-I.
.....
-lmpich -L/usr/X11/lib -lm
-o .../OpenFOAM/OpenFOAM-1.6/applications/bin/linuxOptMPICH/pisofFoam
```

The user can now try recompiling and will receive a message similar to the following to say that the executable is up to date and compiling is not necessary:

```
make: Nothing to be done for 'allFiles'.
make: 'Make/linuxOptMPICH/dependencies' is up to date.

make: '.../OpenFOAM/OpenFOAM-1.6/applications/bin/linuxOptMPICH/pisofFoam'
is up to date.
```

The user can compile the application from scratch by removing the dependency list with

```
wclean
```

and running `wmake`.

### 3.2.5 Debug messaging and optimisation switches

OpenFOAM provides a system of messaging that is written during runtime, most of which are to help debugging problems encountered during running of a OpenFOAM case. The switches are listed in the `$WM_PROJECT_DIR/etc/controlDict` file; should the user wish to change the settings they should make a copy to their `$HOME` directory, *i.e.* `$HOME/.OpenFOAM/1.6/controlDict` file. The list of possible switches is extensive and can be viewed by running the `foamDebugSwitches .147034(a)0.245057(i)0.220551(n)-0.314489(s)0.220551]TJ`



`fileModificationSkew`. OpenFOAM scans the write time of data files to check for modification. When running over a NFS with some disparity in the clock settings on different machines, field data files appear to be modified ahead of time. This can cause a problem if OpenFOAM views the files as newly modified and attempting to re-read this data. The `fileModificationSkew` keyword is the time in seconds that OpenFOAM will subtract from the file write time when assessing whether the file has been newly modified.

---

#### High level debugging switches - sub-dictionary *DebugSwitches*

---

<code>level</code>	Overall level of debugging messaging for OpenFOAM- - 3 levels 0, 1, 2
<code>lduMatrix</code>	Messaging for solver convergence during a run - 3 levels 0, 1, 2

---

#### Optimisation switches - sub-dictionary *OptimisationSwitches*

---

<code>fileModificationSkew</code>	A time in seconds that should be set higher than the maximum delay in NFS updates and clock difference for running OpenFOAM over a NFS.
<code>nProcsSimpleSum</code>	Optimises global sum for parallel processing; sets number of processors above which hierarchical sum is performed rather than a linear sum (default 16)

---

Table 3.3: Runtime message switches.

### 3.2.6 Linking new user-defined libraries to existing applications

The situation may arise that a user creates a new library, say `new`, and wishes the features within that library to be available across a range of applications. For example, the user may create a new boundary condition, compiled into `new`, that would need to be recognised by a range of solver applications, pre- and post-processing utilities, mesh tools, *etc.* Under normal circumstances, the user would need to recompile every application with the `new` linked to it.

Instead there is a simple mechanism to link one or more shared object libraries dynamically at run-time in OpenFOAM. Simply add the optional keyword entry `libs` to the `controlDict` file for a case and enter the full names of the libraries within a list (as quoted string entries). For example, if a user wished to link the libraries `new1` and `new2` at run-time, they would simply need to add the following to the case `controlDict` file:

```
libs
(
    "libnew1.so"
    "libnew2.so"
);
```

## 3.3 Running applications

Each application is designed to be executed from a terminal command line, typically reading and writing a set of data files associated with a particular case. The data files for a case are stored in a directory named after the case as described in [section 4.1](#); the directory name with full path is here given the generic name `<caseDir>`.



For any application, the form of the command line entry for any can be found by simply entering the application name at the command line with the `-help` option, *e.g.* typing

```
blockMesh -help
```

returns the usage

```
Usage: blockMesh [-region region name] [-case dir] [-blockTopology]
        [-help] [-doc] [-srcDoc]
```

The arguments in square brackets, [ ], are optional flags. If the application is executed from within a case directory, it will operate on that case. Alternatively, the `-case <caseDir>` option allows the case to be specified directly so that the application can be executed from anywhere in the filing system.

Like any UNIX/Linux executable, applications can be run as a background process, *i.e.* one which does not have to be completed before the user can give the shell additional commands. If the user wished to run the `blockMesh` example as a background process and output the case progress to a *log* file, they could enter:

```
blockMesh > log &
```

## 3.4 Running applications in parallel

This section describes how to run OpenFOAM in parallel on distributed processors. The method of parallel computing used by OpenFOAM is known as domain decomposition, in which the geometry and associated fields are broken into pieces and allocated to separate processors for solution. The process of parallel computation involves: decomposition of mesh and fields; running the application in parallel; and, post-processing the decomposed case as described in the following sections. The parallel running uses the public domain `openMPI` implementation of the standard message passing interface (MPI).

### 3.4.1 Decomposition of mesh and initial field data

The mesh and fields are decomposed using the `decomposePar` utility. The underlying aim is to break up the domain with minimal effort but in such a way to guarantee a fairly economic solution. The geometry and fields are broken up according to a set of parameters specified in a dictionary named *decomposeParDict* that must be located in the *system* directory of the case of interest. An example *decomposeParDict* dictionary can be copied from the `interFoam/damBreak` tutorial if the user requires one; the dictionary entries within it are reproduced below:

```
17
18  numberOfSubdomains 4;
19
20  method          simple;
21
22  simpleCoeffs
23  {
24      n              ( 2 2 1 );
25      delta          0.001;
26  }
27
28  hierarchicalCoeffs
29  {
30      n              ( 1 1 1 );
```

```
31     delta          0.001;
32     order          xyz;
33 }
34
35 metisCoeffs
36 {
37     processorWeights ( 1 1 1 1 );
38 }
39
40 manualCoeffs
41 {
42     dataFile        "";
43 }
44
45 distributed        no;
46
47 roots              ( );
48
49
50 // ***** //
```

The user has a choice of four methods of decomposition, specified by the `method` keyword as described below.

**simple** Simple geometric decomposition in which the domain is split into pieces by direction, *e.g.* 2 pieces in the  $x$  direction, 1 in  $y$  *etc.*

**hierarchical**

<b>Compulsory entries</b>		
numberOfSubdomains	Total number of subdomains	$N$
method	Method of decomposition	simple/ hierarchical/ scotch/   metis/ manual/
<b>simpleCoeffs entries</b>		
n	Number of subdomains in $x, y, z$	$(n_x, n_y, n_z)$
delta	Cell skew factor	Typically, $10^{-3}$
<b>hierarchicalCoeffs entries</b>		
n	Number of subdomains in $x, y, z$	$(n_x, n_y, n_z)$
delta	Cell skew factor	Typically, $10^{-3}$
order	Order of decomposition	xyz/xzy/yxz...
<b>scotchCoeffs entries</b>		
processorWeights	List of weighting factors for allocation of cells to processors; $\langle \text{wt1} \rangle$ is the weighting factor for processor 1, <i>etc.</i> ; weights are normalised so can take any range of values.	$(\langle \text{wt1} \rangle \dots \langle \text{wtN} \rangle)$
strategy	Decomposition strategy; defaults to "b"	
<b>metisCoeffs entries</b>		
processorWeights	As above	$(\langle \text{wt1} \rangle \dots \langle \text{wtN} \rangle)$
<b>manualCoeffs entries</b>		
dataFile	Name of file containing data of allocation of cells to processors	" $\langle \text{fileName} \rangle$ "
<b>Distributed data entries (optional) — see <a href="#">section 3.4.3</a></b>		
distributed	Is the data distributed across several disks?	yes/no
roots	Root paths to case directories; $\langle \text{rt1} \rangle$ is the root path for node 1, <i>etc.</i>	$(\langle \text{rt1} \rangle \dots \langle \text{rtN} \rangle)$

Table 3.4: Keywords in *decompositionDict* dictionary.

### 3.4.2 Running a decomposed case

A decomposed OpenFOAM case is run in parallel using the openMPI implementation of MPI.

openMPI can be run on a local multiprocessor machine very simply but when running on machines across a network, a file must be created that contains the host names of the machines. The file can be given any name and located at any path. In the following description we shall refer to such a file by the generic name, including full path,  $\langle \text{machines} \rangle$ .

The  $\langle \text{machines} \rangle$  file contains the names of the machines listed one machine per line.

The names must correspond to a fully resolved hostname in the `/etc/hosts` file of the machine on which the `openMPI` is run. The list must contain the name of the machine running the `openMPI`. Where a machine node contains more than one processor, the node name may be followed by the entry `cpu=n` where *n* is the number of processors `openMPI` should run on that node.

For example, let us imagine a user wishes to run `openMPI` from machine `aaa` on the following machines: `aaa`; `bbb`, which has 2 processors; and `ccc`. The `<machines>` would contain:

```
aaa
bbb cpu=2
ccc
```

An application is run in parallel using `mpirun`.

```
mpirun --hostfile <machines> -np <nProcs>
      <foamExec> <otherArgs> -parallel > log &
```

where: `<nProcs>` is the number of processors; `<foamExec>` is the executable, *e.g.* `icoFoam`; and, the output is redirected to a file named `log`. For example, if `icoFoam` is run on 4 nodes, specified in a file named `machines`, on the `cavity` tutorial in the `$FOAM_RUN/tutorials/incompressible/icoFoam` directory, then the following command should be executed:

```
mpirun --hostfile machines -np 4 icoFoam -parallel > log &
```

### 3.4.3 Distributing data across several disks

Data files may need to be distributed if, for example, if only local disks are used in order to improve performance. In this case, the user may find that the root path to the case directory may differ between machines. The paths must then be specified in the `decomposeParDict` dictionary using `distributed` and `roots` keywords. The `distributed` entry should read

```
distributed yes;
```

and the `roots` entry is a list of root paths, `<root0>`, `<root1>`, ..., for each node

```
roots
<nRoots>
(
  "<root0>"
  "<root1>"
  ...
);
```

where `<nRoots>` is the number of roots.

Each of the `processorN` directories should be placed in the case directory at each of the root paths specified in the `decomposeParDict` dictionary. The `system` directory and `files` within the `constant` directory must also be present in each case directory. Note: the files in the `constant` directory are needed, but the `polyMesh` directory is not.

### 3.4.4 Post-processing parallel processed cases

When post-processing cases that have been run in parallel the user has two options:

- reconstruction of the mesh and field data to recreate the complete domain and fields, which can be post-processed as normal;
- post-processing each segment of decomposed domain individually.

#### 3.4.4.1 Reconstructing mesh and data

After a case has been run in parallel, it can be reconstructed for post-processing. The case is reconstructed by merging the sets of time directories from each *processorN* directory into a single set of time directories. The `reconstructPar` utility performs such a reconstruction by executing the command:

```
reconstructPar
```

When the data is distributed across several disks, it must be first copied to the local case directory for reconstruction.

#### 3.4.4.2 Post-processing decomposed cases

The user may post-process decomposed cases using the `paraFoam` post-processor, described in [section 6.1](#). The whole simulation can be post-processed by reconstructing the case or alternatively it is possible to post-process a segment of the decomposed domain individually by simply treating the individual processor directory as a case in its own right.

## 3.5 Standard solvers

The solvers with the OpenFOAM distribution are in the `$FOAM_SOLVERS` directory, reached quickly by typing `app` at the command line. This directory is further subdivided into several directories by category of continuum mechanics, *e.g.* incompressible flow, combustion and solid body stress analysis. Each solver is given a name that is reasonably descriptive, *e.g.* `icoFoam` solves incompressible, laminar flow. The current list of solvers distributed with OpenFOAM is given in [Table 3.5](#).

### ‘Basic’ CFD codes

<code>laplacianFoam</code>	Solves a simple Laplace equation, <i>e.g.</i> for thermal diffusion in a solid
<code>potentialFoam</code>	Simple potential flow solver which can be used to generate starting fields for full Navier-Stokes codes
<code>scalarTransportFoam</code>	Solves a transport equation for a passive scalar

### Incompressible flow

<code>boundaryFoam</code>	Steady-state solver for 1D turbulent flow, typically to generate boundary layer conditions at an inlet, for use in a simulation
<code>channelFoam</code>	Incompressible LES solver for flow in a channel
<code>icoFoam</code>	Transient solver for incompressible, laminar flow of Newtonian fluids

*Continued on next page*

*Continued from previous page*

nonNewtonianIcoFoam	Transient solver for incompressible, laminar flow of non-Newtonian fluids
pimpleDyMFoam	Transient solver for incompressible, flow of Newtonian fluids on a moving mesh using the PIMPLE (merged PISO-SIMPLE) algorithm
pimpleFoam	Large time-step transient solver for incompressible, flow using the PIMPLE (merged PISO-SIMPLE) algorithm
pisoFoam	Transient solver for incompressible flow
shallowWaterFoam	Transient solver for inviscid shallow-water equations with rotation
simpleFoam	Steady-state solver for incompressible, turbulent flow

### Compressible flow

---

rhoCentralFoam	Density-based compressible flow solver based on central-upwind schemes of Kurganov and Tadmor
rhoPimpleFoam	Transient solver for laminar or turbulent flow of compressible fluids for HVAC and similar applications
rhoPisoFoam	Transient PISO solver for compressible, laminar or turbulent flow
rhoPorousSimpleFoam	Steady-state solver for turbulent flow of compressible fluids with RANS turbulence modelling, and implicit or explicit porosity treatment
rhoPsonicFoam	Pressure-density-based compressible flow solver
rhoSimpleFoam	Steady-state SIMPLE solver for laminar or turbulent RANS flow of compressible fluids
rhoSonicFoam	Density-based compressible flow solver
sonicDyMFoam	Transient solver for trans-sonic/supersonic, laminar or turbulent flow of a compressible gas with mesh motion
sonicFoam	Transient solver for trans-sonic/supersonic, laminar or turbulent flow of a compressible gas
sonicLiquidFoam	Transient solver for trans-sonic/supersonic, laminar flow of a compressible liquid

### Multiphase flow

---

bubbleFoam	Solver for a system of 2 incompressible fluid phases with one phase dispersed, e.g. gas bubbles in a liquid
cavitatingFoam	Transient cavitation code based on the barotropic equation of state
compressibleInterDyMFoam	Solver for 2 compressible, isothermal immiscible fluids using a VOF (volume of fluid) phase-fraction based interface capturing approach, with optional mesh motion and mesh topology changes including adaptive re-meshing
compressibleInterFoam	Solver for 2 compressible, isothermal immiscible fluids using a VOF (volume of fluid) phase-fraction based interface capturing approach
interDyMFoam	Solver for 2 incompressible, isothermal immiscible fluids using a VOF (volume of fluid) phase-fraction based interface capturing approach, with optional mesh motion and mesh topology changes including adaptive re-meshing

*Continued on next page*

*Continued from previous page*

interFoam	Solver for 2 incompressible, isothermal immiscible fluids using a VOF (volume of fluid) phase-fraction based interface capturing approach
interPhaseChangeFoam	Solver for 2 incompressible, isothermal immiscible fluids with phase-change (e.g. cavitation). Uses a VOF (volume of fluid) phase-fraction based interface capturing approach
multiphaseInterFoam	Solver for $n$ incompressible fluids which captures the interfaces and includes surface-tension and contact-angle effects for each phase
settlingFoam	Solver for 2 incompressible fluids for simulating the settling of the dispersed phase
twoLiquidMixingFoam	Solver for mixing 2 incompressible fluids
twoPhaseEulerFoam	Solver for a system of 2 incompressible fluid phases with one phase dispersed, e.g. gas bubbles in a liquid

---

### Direct numerical simulation (DNS)

dnsFoam	Direct numerical simulation solver for boxes of isotropic turbulence
---------	--

---

### Combustion

coldEngineFoam	Solver for cold-flow in internal combustion engines
dieselEngineFoam	Solver for diesel engine spray and combustion
dieselFoam	Solver for diesel spray and combustion
engineFoam	Solver for internal combustion engines
PDRFoam	Solver for compressible premixed/partially-premixed combustion with turbulence modelling
reactingFoam	Solver for combustion with chemical reactions
rhoReactingFoam	Solver for combustion with chemical reactions using density based thermodynamics package
XiFoam	Solver for compressible premixed/partially-premixed combustion with turbulence modelling

---

### Heat transfer and buoyancy-driven flows

buoyantBoussinesqPisoFoam	Transient solver for buoyant, turbulent flow of incompressible fluids
---------------------------	---

*Continued from previous page*

coalChemistryFoam	Transient solver for compressible, turbulent flow with coal and limestone parcel injections, and combustion
porousExplicitSource-ReactingParcelFoam	Transient PISO solver for compressible, laminar or turbulent flow with reacting Lagrangian parcels for porous media, including explicit sources
reactingParcelFoam	Transient PISO solver for compressible, laminar or turbulent flow with reacting Lagrangian parcels
uncoupledKinematicParcelFoam	Transient solver for the passive transport of a single kinematic particle cloud
<b>Molecular dynamics methods</b>	
mdEquilibrationFoam	Equilibrates and/or preconditions molecular dynamics systems
mdFoam	Molecular dynamics solver for fluid dynamics
<b>Direct simulation Monte Carlo methods</b>	
dsmcFoam	Direct simulation Monte Carlo (DSMC) solver for 3D, transient, multi-species flows
<b>Electromagnetics</b>	
electrostaticFoam	Solver for electrostatics
mhdFoam	Solver for magnetohydrodynamics (MHD): incompressible, laminar flow of a conducting fluid under the influence of a magnetic field
<b>Stress analysis of solids</b>	
solidDisplacementFoam	Transient segregated finite-volume solver of linear-elastic, small-strain deformation of a solid body, with optional thermal diffusion and thermal stresses
solidEquilibriumDisplacementFoam	Steady-state segregated finite-volume solver of linear-elastic, small-strain deformation of a solid body, with optional thermal diffusion and thermal stresses
<b>Finance</b>	
financialFoam	Solves the Black-Scholes equation to price commodities

Table 3.5: Standard library solvers.



*Continued from previous page*

### Pre-processing

---

applyBoundaryLayer	Apply a simplified boundary-layer model to the velocity and turbulence fields based on the 1/7th power-law
applyWallFunction-BoundaryConditions	Updates OpenFOAM RAS cases to use the new wall function framework Attempts to determine whether case is compressible or incompressible, or can be supplied with -compressible command line argument
boxTurb	Makes a box of turbulence which conforms to a given energy spectrum and is divergence free
changeDictionary	Utility to change dictionary entries, e.g. can be used to change the patch type in the field and polyMesh/boundary files
dsmcInitialise	Initialise a case for <code>dsmcFoam</code> by reading the initialisation dictionary <code>system/dsmcInitialise</code>
engineSwirl	Generates a swirling flow for engine calculations
foamUpgradeFvSolution	Simple tool to upgrade the syntax of <code>system/fvSolution::solvers</code>
mapFields	Maps volume fields from one mesh to another, reading and interpolating all fields present in the time directory of both cases. Parallel and non-parallel cases are handled without the need to reconstruct them first
mdInitialise	Initialises fields for a molecular dynamics (MD) simulation
setFields	Selects a cell set through a dictionary

### Mesh generation

---

blockMesh	A multi-block mesh generator
extrude2DMesh	Takes 2D mesh (all faces 2 points only, no front and back faces) and creates a 3D mesh by extruding with specified thickness
extrudeMesh	Extrude mesh from existing patch (by default outwards facing normals; optional flips faces) or from patch read from file
snappyHexMesh	Automatic split hex mesher. Refines and snaps to surface

### Mesh conversion

---

ansysToFoam	Converts an ANSYS input mesh file, exported from I-DEAS, to OpenFOAM format
cfx4ToFoam	Converts a CFX 4 mesh to OpenFOAM format
fluent3DMeshToFoam	Converts a Fluent mesh to OpenFOAM format
fluentMeshToFoam	Converts a Fluent mesh to OpenFOAM format including multiple region and region boundary handling
foamMeshToFluent	Writes out the OpenFOAM mesh in Fluent mesh format
foamToStarMesh	Reads an OpenFOAM mesh and writes a PROSTAR (v4) bnd/cel/vrt format
gambitToFoam	Converts a GAMBIT mesh to OpenFOAM format
gmshToFoam	Reads .msh file as written by Gmsh
ideasUnvToFoam	I-Deas unv format mesh conversion
kivaToFoam	Converts a KIVA grid to OpenFOAM format
mshToFoam	Converts .msh file generated by the Adventure system
netgenNeutralToFoam	Converts neutral file format as written by Netgen v4.4
plot3dToFoam	Plot3d mesh (ascii/formatted format) converter

*Continued on next page*

*Continued from previous page*

polyDualMesh	Calculate the dual of a polyMesh. Adheres to all the feature and patch edges
sammToFoam	Converts a STAR-CD SAMP mesh to OpenFOAM format
star4ToFoam	Converts a STAR-CD (v4) PROSTAR mesh into OpenFOAM format
starToFoam	Converts a STAR-CD PROSTAR mesh into OpenFOAM format
tetgenToFoam	Converts .ele and .node and .face files, written by tetgen
writeMeshObj	For mesh debugging: writes mesh as three separate OBJ files which can be viewed with e.g. javaview

### Mesh manipulation

attachMesh	Attach topologically detached mesh using prescribed mesh modifiers
autoPatch	Divides external faces into patches based on (user supplied) feature angle
cellSet	Selects a cell set through a dictionary
checkMesh	Checks validity of a mesh
createBaffles	Makes internal faces into boundary faces. Does not duplicate points, unlike <code>mergeOrSplitBaffles</code>
createPatch	Utility to create patches out of selected boundary faces. Faces come either from existing patches or from a <code>faceSet</code>
deformedGeom	Deforms a polyMesh using a displacement field $U$ and a scaling factor supplied as an argument
faceSet	Selects a face set through a dictionary
flattenMesh	Flattens the front and back planes of a 2D cartesian mesh
insideCells	Picks up cells with cell centre 'inside' of surface. Requires surface to be closed and singly connected
mergeMeshes	Merge two meshes
mergeOrSplitBaffles	Detects faces that share points (baffles). Either merge them or duplicate the points
mirrorMesh	Mirrors a mesh around a given plane
moveDynamicMesh	Mesh motion and topological mesh changes utility
moveEngineMesh	Solver for moving meshes for engine calculations.
moveMesh	Solver for moving meshes
objToVTK	Read obj line (not surface!) file and convert into vtk
pointSet	Selects a point set through a dictionary
refineMesh	Utility to refine cells in multiple directions
renumberMesh	Renumbers the cell list in order to reduce the bandwidth, reading and renumbering all fields from all the time directories
rotateMesh	Rotates the mesh and fields from the direction $n_1$ to the direction $n_2$
setSet	Manipulate a cell/face/point set interactively
setsToZones	Add <code>pointZones/faceZones/cellZones</code> to the mesh from similar named <code>pointSets/faceSets/cellSets</code>
splitMesh	Splits mesh by making internal faces external. Uses <code>attachDetach</code>
splitMeshRegions	Splits mesh into multiple regions
stitchMesh	'Stitches' a mesh

*Continued on next page*

*Continued from previous page*

subsetMesh	Selects a section of mesh based on a <code>cellSet</code>
transformPoints	Transforms the mesh points in the <code>polyMesh</code> directory according to the <code>translate</code> , <code>rotate</code> and <code>scale</code> options
zipUpMesh	Reads in a mesh with hanging vertices and zips up the cells to guarantee that all polyhedral cells of valid shape are closed

### Other mesh tools

---

autoRefineMesh	Utility to refine cells near to a surface
collapseEdges	Collapse short edges and combines edges that are in line
combinePatchFaces	Checks for multiple patch faces on same cell and combines them. These result from e.g. refined neighbouring cells getting removed, leaving 4 exposed faces with same owner
modifyMesh	Manipulates mesh elements
refineHexMesh	Refines a hex mesh by 2x2x2 cell splitting
refinementLevel	Tries to figure out what the refinement level is on refined cartesian meshes. Run <i>before</i> snapping
refineWallLayer	Utility to refine cells next to patches
removeFaces	Utility to remove faces (combines cells on both sides)
selectCells	Select cells in relation to surface
splitCells	Utility to split cells with flat faces

### Post-processing graphics

---

ensightFoamReader	EnSight library module to read OpenFOAM data directly without translation
fieldview9Reader	Reader module for Fieldview 9 to read OpenFOAM mesh and data
PV3FoamReader	ParaView 3 reader module
PVFoamReader	ParaView reader module

### Post-processing data converters

---

foamDataToFluent	Translates OpenFOAM data to Fluent format
foamToEnight	Translates OpenFOAM data to EnSight format
foamToEnightParts	Translates OpenFOAM data to Enight format. An Enight part is created for each <code>cellZone</code> and patch
foamToFieldview9	Write out the OpenFOAM mesh in Version 3.0 Fieldview-UNS format (binary)
foamToGMV	Translates foam output to GMV readable files
foamToVTK	Legacy VTK file format writer
smapToFoam	Translates a STAR-CD SMAP data file into OpenFOAM field format

### Post-processing velocity fields

---

Co	Configurable graph drawing program
enstrophy	Calculates and writes the enstrophy of the velocity field $\mathbf{U}$
flowType	Calculates and writes the flowType of velocity field $\mathbf{U}$
Lambda2	Calculates and writes the second largest eigenvalue of the sum of the square of the symmetrical and anti-symmetrical parts of the velocity gradient tensor

*Continued on next page*

*Continued from previous page*

Mach	Calculates and optionally writes the local Mach number from the velocity field <code>U</code> at each time
Pe	Calculates and writes the Pe number as a <code>surfaceScalarField</code> obtained from field <code>phi</code>
Q	Calculates and writes the second invariant of the velocity gradient tensor
streamFunction	Calculates and writes the stream function of velocity field <code>U</code> at each time
uprime	Calculates and writes the scalar field of <code>uprime</code> ( $\sqrt{2k/3}$ )
vorticity	Calculates and writes the vorticity of velocity field <code>U</code>

---

### Post-processing stress fields

stressComponents	Calculates and writes the scalar fields of the six components of the stress tensor <code>sigma</code> for each time
------------------	---

---

### Post-processing scalar fields

pPrime2	Calculates and writes the scalar field of <code>pPrime2</code> ( $[p - \bar{p}]^2$ ) at each time
---------	---

---

### Post-processing at walls

wallGradU	Calculates and writes the gradient of <code>U</code> at the wall
wallHeatFlux	Calculates and writes the heat flux for all patches as the boundary field of a <code>volScalarField</code> and also prints the integrated flux for all wall patches
wallShearStress	Calculates and writes the wall shear stress, for the specified times
yPlusLES	Calculates and reports <code>yPlus</code> for all wall patches, for the specified times
yPlusRAS	Calculates and reports <code>yPlus</code> for all wall patches, for the specified times

---

### Post-processing turbulence

createTurbulenceFields	Creates a full set of turbulence fields
R	Calculates and writes the Reynolds stress <code>R</code> for the current time step

---

### Post-processing patch data

patchAverage	Calculates the average of the specified field over the specified patch
patchIntegrate	Calculates the integral of the specified field over the specified patch

---

### Post-processing Lagrangian simulation

particleTracks	Generates a VTK file of particle tracks for cases that were computed using a tracked-parcel-type cloud
----------------	--

---

### Sampling post-processing

probeLocations	Probe locations
----------------	-----------------

*Continued on next page*

*Continued from previous page*

**sample** Sample field data with a choice of interpolation schemes, sampling options and write formats

### Miscellaneous post-processing

---

**dsmcFieldsCalc** Calculate intensive fields (U and T) from averaged extensive fields from a DSMC calculation

**engineCompRatio** Calculate the geometric compression ratio. Note that if you have valves and/or extra volumes it will not work, since it calculates the volume at BDC and TCD

**execFlowFunctionObjects** Execute the set of functionObjects specified in the selected dictionary (which defaults to *system/controlDict*) for the selected set of times

**pdfPlot** Generates an .obj file to plot a probability distribution function

**postChannel** Post-processes data from channel flow calculations

**ptot** For each time: calculate the total pressure

**wdot** Calculates and writes wdot for each time

**writeCellCentres** Write the three components of the cell centres as *volScalarFields* so they can be used in postprocessing in thresholding

### Parallel processing

---

**decomposePar** Automatically decomposes a mesh and fields of a case for parallel execution of OpenFOAM

**reconstructPar** Reconstructs a mesh and fields of a case that is decomposed for parallel execution of OpenFOAM

**reconstructParMesh** Reconstructs a mesh using geometric information only

**redistributeMeshPar** Redistributes existing decomposed mesh and fields according to the current settings in the *decomposeParDict* file

### Thermophysical-related utilities

---

**adiabaticFlameT** Calculates the adiabatic flame temperature for a given fuel over a range of unburnt temperatures and equivalence ratios

**chemkinToFoam** Converts CHEMKIN 3 thermodynamics and reaction data files into OpenFOAM format

**equilibriumCO** Calculates the equilibrium level of carbon monoxide

**equilibriumFlameT** Calculates the equilibrium flame temperature for a given fuel and pressure for a range of unburnt gas temperatures and equivalence ratios; the effects of dissociation on O<sub>2</sub>, H<sub>2</sub>O and CO<sub>2</sub> are included

**mixtureAdiabaticFlameT** Calculates the adiabatic flame temperature for a given mixture at a given temperature

### Error estimation

---

**estimateScalarError** Estimates the error in the solution for a scalar transport equation in the standard form

**icoErrorEstimate** Estimates error for the incompressible laminar CFD application *icoFoam*

*Continued on next page*

*Continued from previous page*

icoMomentError	Estimates error for the incompressible laminar CFD application <code>icoFoam</code>
momentScalarError	Estimates the error in the solution for a scalar transport equation in the standard form

### Miscellaneous utilities

expandDictionary	Read the dictionary provided as an argument, expand the macros etc. and write the resulting dictionary to standard output
foamDebugSwitches	Write out all library debug switches
foamFormatConvert	Converts all <code>IObject</code> s associated with a case into the format specified in the <code>controlDict</code>
foamInfoExec	Interrogates a case and prints information to screen
patchSummary	Writes fields and boundary condition info for each patch at each requested time instance

Table 3.6: Standard library utilities.

## 3.7 Standard libraries

The libraries with the OpenFOAM distribution are in the `$FOAM_LIB/$WM_OPTIONS` directory, reached quickly by typing `lib` at the command line. Again, the names are prefixed by `lib` and reasonably descriptive, *e.g.* `incompressibleTransportModels` contains the library of incompressible transport models. For ease of presentation, the libraries are separated into two types:

**General libraries** those that provide general classes and associated functions listed in [Table 3.7](#);

**Model libraries** those that specify models used in computational continuum mechanics, listed in [Table 3.8](#), [Table 3.9](#) and [Table 3.10](#).

### Library of basic OpenFOAM tools — OpenFOAM

algorithms	Algorithms
containers	Container classes
db	Database classes
dimensionedTypes	<code>dimensioned&lt;Type&gt;</code> class and derivatives
dimensionSet	<code>dimensionSet</code> class
fields	Field classes
global	Global settings
graph	<code>graph</code> class
interpolations	Interpolation schemes
matrices	Matrix classes
memory	Memory management tools
meshes	Mesh classes
primitives	Primitive classes

*Continued on next page*



*Continued from previous page*

### **Finite volume method library — finiteVolume**

---

cfdTools	CFD tools
fields	Volume, surface and patch field classes; includes boundary conditions
finiteVolume	Finite volume discretisation
fvMatrices	Matrices for finite volume solution
fvMesh	Meshes for finite volume discretisation
interpolation	Field interpolation and mapping
surfaceMesh	Mesh surface data for finite volume discretisation Mesh volume (cell) data for finite volume discretisation

### **Post-processing libraries**

---

fieldFunctionObjects	Field function objects including field averaging, min/max, <i>etc.</i>
foamCalcFunctions	Functions for the foamCalc utility
forces	Tools for post-processing force/lift/drag data with function objects
postCalc	For using functionality of a function object as a post-processing activity
sampling	Tools for sampling field data at prescribed locations in a domain
systemCall	General function object for making system calls while running a case
utilityFunctionObjects	Utility function objects

### **Solution and mesh manipulation libraries**

---

autoMesh	Library of functionality for the snappyHexMesh utility
dynamicMesh	For solving systems with moving meshes
dynamicFvMesh	Library for a finite volume mesh that can move and undergo topological changes
edgeMesh	For handling edge-based mesh descriptions
errorEstimation	Error estimation tools
fvMotionSolver	Finite volume mesh motion solvers
ODE	Solvers for ordinary differential equations
meshTools	Tools for handling a OpenFOAM mesh
surfMesh	Library for handling surface meshes of different formats
triSurface	For handling standard triangulated surface-based mesh descriptions
topoChangerFvMesh	Topological changes functionality (largely redundant)

### **Lagrangian particle tracking libraries**

---

coalCombustion	Coal dust combustion modelling
dieselSpray	Diesel spray and injection modelling
dsmc	Direct simulation Monte Carlo method modelling
lagrangian	Basic Lagrangian, or particle-tracking, solution scheme
lagrangianIntermediate	Particle-tracking kinematics, thermodynamics, multispecies reactions, particle forces, <i>etc.</i>
potential	Intermolecular potentials for molecular dynamics
molecule	Molecule classes for molecular dynamics
molecularMeasurements	For making measurements in molecular dynamics

*Continued on next page*

*Continued from previous page*

solidParticle Solid particle implementation

### Miscellaneous libraries

---

conversion	Tools for mesh and data conversions
decompositionMethods	Tools for domain decomposition
engine	Tools for engine calculations
MGridGenGAMGAgglomeration	Library for cell agglomeration using the MGridGen algorithm
OSspecific	Operating system specific functions
randomProcesses	Tools for analysing and generating random processes

Table 3.7: Shared object libraries for general use.

### Basic thermophysical models — basicThermophysicalModels

---

hPsiThermo	General thermophysical model calculation based on enthalpy $h$ and compressibility $\psi$
ePsiThermo	General thermophysical model calculation based on internal energy $e$ and compressibility $\psi$
hRhoThermo	General thermophysical model calculation based on enthalpy $h$
pureMixture	General thermophysical model calculation for passive gas mixtures

### Reaction models — reactionThermophysicalModels

---

hPsiMixtureThermo	Calculates enthalpy for combustion mixture based on $\psi$
hRhoMixtureThermo	Calculates enthalpy for combustion mixture based on $\rho$
hhuMixtureThermo	Calculates enthalpy for unburnt gas and combustion mixture
homogeneousMixture	Combustion mixture based on normalised fuel mass fraction $b$
inhomogeneousMixture	Combustion mixture based on $b$ and total fuel mass fraction $f_t$
veryInhomogeneousMixture	Combustion mixture based on $b$ , $f_t$ and unburnt fuel mass fraction $f_u$
dieselMixture	Combustion mixture based on $f_t$ and $f_u$
basicMultiComponentMixture	Basic mixture based on multiple components
multiComponentMixture	Derived mixture based on multiple components
reactingMixture	Combustion mixture using thermodynamics and reaction schemes
egrMixture	Exhaust gas recirculation mixture

### Radiation models — radiation

---

P1	P1 model
fvDOM	Finite volume discrete ordinate method

*Continued on next page*



*Continued from previous page*

---

### Laminar flame speed models — laminarFlameSpeedModels

constLaminarFlameSpeed	Constant laminar flame speed
GuldersLaminarFlameSpeed	Gülnder's laminar flame speed model
GuldersEGR Laminar-FlameSpeed	Gülnder's laminar flame speed model with exhaust gas recirculation modelling

---

### Barotropic compressibility models — barotropicCompressibilityModels

linear	Linear compressibility model
Chung	Chung compressibility model
Wallis	Wallis compressibility model

---

### Thermophysical properties of gaseous species — specie

icoPolynomial	Incompressible polynomial equation of state, <i>e.g.</i> for liquids
perfectGas	Perfect gas equation of state
eConstThermo	Constant specific heat $c_p$ model with evaluation of internal energy $e$ and entropy $s$
hConstThermo	Constant specific heat $c_p$ model with evaluation of enthalpy $h$ and entropy $s$
hPolynomialThermo	$c_p$ evaluated by a function with coefficients from polynomials, from which $h$ , $s$ are evaluated
janafThermo	$c_p$ evaluated by a function with coefficients from JANAF thermodynamic tables, from which $h$ , $s$ are evaluated
specieThermo	Thermophysical properties of species, derived from $c_p$ , $h$ and/or $s$
constTransport	Constant transport properties
polynomialTransport	Polynomial based temperature-dependent transport properties
sutherlandTransport	Sutherland's formula for temperature-dependent transport properties

---

### Functions/tables of thermophysical properties — thermophysicalFunctions

NSRDSfunctions	National Standard Reference Data System (NSRDS) - American Institute of Chemical Engineers (AIChE) data compilation tables
APIfunctions	American Petroleum Institute (API) function for vapour mass diffusivity

---

### Probability density functions — pdf

RosinRammler	Rosin-Rammler distribution
normal	Normal distribution
uniform	Uniform distribution
exponential	Exponential distribution
general	General distribution

---

### Chemistry model — chemistryModel

chemistryModel	Chemical reaction model
chemistrySolver	Chemical reaction solver

*Continued on next page*

Continued from previous page

### Other libraries

liquids	Thermophysical properties of liquids
liquidMixture	Thermophysical properties of liquid mixtures
solids	Thermophysical properties of solids
solidMixture	Thermophysical properties of solid mixtures

Table 3.8: Libraries of thermophysical models.

### RAS turbulence models for incompressible fluids — incompressibleRASModels

laminar	Dummy turbulence model for laminar flow
kEpsilon	Standard high- $Re$ $k - \varepsilon$ model
kOmega	Standard high- $Re$ $k - \omega$ model
kOmegaSST	$k - \omega$ -SST model
RNGkEpsilon	RNG $k - \varepsilon$ model
NonlinearKEShih	Non-linear Shih $k - \varepsilon$ model
LienCubicKE	Lien cubic $k - \varepsilon$ model
qZeta	$q - \zeta$ model
LaunderSharmaKE	Launder-Sharma low- $Re$ $k - \varepsilon$ model
LamBremhorstKE	Lam-Bremhorst low- $Re$ $k - \varepsilon$ model
LienCubicKELowRe	Lien cubic low- $Re$ $k - \varepsilon$ model
LienLeschzinerLowRe	Lien-Leschziner low- $Re$ $k - \varepsilon$ model
LRR	Launder-Reece-Rodi RSTM
LaunderGibsonRSTM	Launder-Gibson RSTM with wall-reflection terms
realizableKE	Realizable $k - \varepsilon$ model
SpalartAllmaras	Spalart-Allmaras 1-eqn mixing-length model

### RAS turbulence models for compressible fluids — compressibleRASModels

laminar	Dummy turbulence model for laminar flow
kEpsilon	Standard $k - \varepsilon$ model
kOmegaSST	$k - \omega - SST$ model
RNGkEpsilon	RNG $k - \varepsilon$ model
LaunderSharmaKE	Launder-Sharma low- $Re$ $k - \varepsilon$ model
LRR	Launder-Reece-Rodi RSTM
LaunderGibsonRSTM	Launder-Gibson RSTM
realizableKE	Realizable $k - \varepsilon$ model
SpalartAllmaras	Spalart-Allmaras 1-eqn mixing-length model

### Large-eddy simulation (LES) filters — LESfilters

laplaceFilter	Laplace filters
simpleFilter	Simple filter
anisotropicFilter	Anisotropic filter

### Large-eddy simulation deltas — LESdeltas

PrandtlDelta	Prandtl delta
cubeRootVolDelta	Cube root of cell volume delta
smoothDelta	Smoothing of delta

Continued on next page

*Continued from previous page*

### **Incompressible LES turbulence models — incompressibleLESModels**

Smagorinsky	Smagorinsky model
Smagorinsky2	Smagorinsky model with 3-D filter
dynSmagorinsky	Dynamic Smagorinsky
scaleSimilarity	Scale similarity model
mixedSmagorinsky	Mixed Smagorinsky/scale similarity model
dynMixedSmagorinsky	Dynamic mixed Smagorinsky/scale similarity model
kOmegaSST	$k - \omega$ -SST scale adaptive simulation (SAS) model
oneEqEddy	$k$ -equation eddy-viscosity model
dynOneEqEddy	Dynamic $k$ -equation eddy-viscosity model
locDynOneEqEddy	Localised dynamic $k$ -equation eddy-viscosity model
spectEddyVisc	Spectral eddy viscosity model
LRDDiffStress	LRR differential stress model
DeardorffDiffStress	Deardorff differential stress model
SpalartAllmaras	Spalart-Allmaras model
SpalartAllmarasDDES	Spalart-Allmaras delayed detached eddy simulation (DDES) model
SpalartAllmarasIDDES	Spalart-Allmaras improved DDES (IDDES) model

### **Compressible LES turbulence models — compressibleLESModels**

Smagorinsky	Smagorinsky model
oneEqEddy	$k$ -equation eddy-viscosity model
dynOneEqEddy	Dynamic $k$ -equation eddy-viscosity model
lowReOneEqEddy	Low- $Re$ $k$ -equation eddy-viscosity model
DeardorffDiffStress	Deardorff differential stress model
SpalartAllmaras	Spalart-Allmaras 1-eqn mixing-length model

Table 3.9: Libraries of RAS and LES turbulence models.

### **Transport models for incompressible fluids — incompressibleTransportModels**

Newtonian	Linear viscous fluid model
CrossPowerLaw	Cross Power law nonlinear viscous model
BirdCarreau	Bird-Carreau nonlinear viscous model
HerschelBulkley	Herschel-Bulkley nonlinear viscous model
powerLaw	Power-law nonlinear viscous model
interfaceProperties	Models for the interface, <i>e.g.</i> contact angle, in multiphase simulations

Table 3.10: Shared object libraries of transport models.



# Chapter 4

## OpenFOAM cases

This chapter deals with the file structure and organisation of OpenFOAM cases. Normally, a user would assign a name to a case, *e.g.* the tutorial case of flow in a cavity is simply named *cavity*. This name becomes the name of a directory in which all the case files and subdirectories are stored. The case directories themselves can be located anywhere but we recommend they are within a *run* subdirectory of the user's project directory, *i.e.*  $\$HOME/OpenFOAM/\{USER\}-1.6$  as described at the beginning of [chapter 2](#). One advantage of this is that the  $\$FOAM.RUN$  environment variable is set to  $\$HOME/OpenFOAM/\{USER\}-1.6/run$  by default; the user can quickly move to that directory by executing a preset alias, *run*, at the command line.

The tutorial cases that accompany the OpenFOAM distribution provide useful examples of the case directory structures. The tutorials are located in the  $\$FOAM.TUTORIALS$  directory, reached quickly by executing the *tut* alias at the command line. Users can view tutorial examples at their leisure while reading this chapter.

### 4.1 File structure of OpenFOAM cases

The basic directory structure for a OpenFOAM case, that contains the minimum set of files required to run an application, is shown in [Figure 4.1](#) and described as follows:

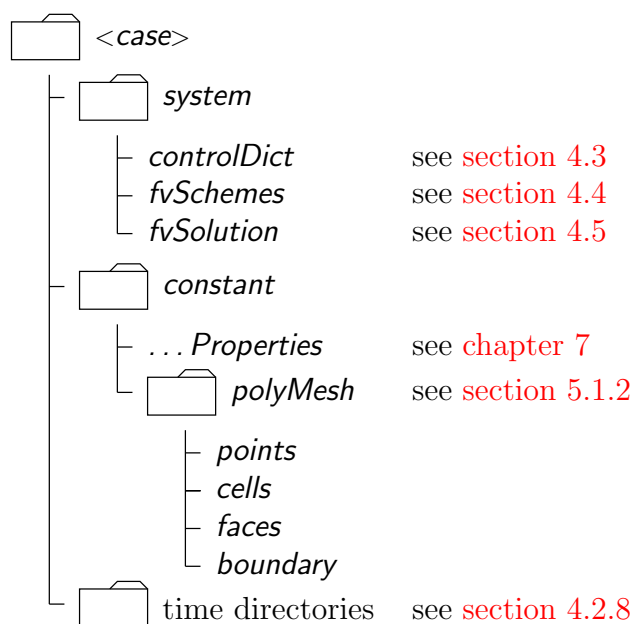

Figure 4.1: Case directory structure

A **constant directory** that contains a full description of the case mesh in a subdirectory *polyMesh* and files specifying physical properties for the application concerned, e.g. *transportProperties*.

A **system directory** for setting parameters associated with the solution procedure itself. It contains *at least* the following 3 files: *controlDict* where run control parameters are set including start/end time, time step and parameters for data output; *fvSchemes* where discretisation schemes used in the solution may be selected at run-time; and, *fvSolution* where the equation solvers, tolerances and other algorithm controls are set for the run.

The ‘**time**’ directories containing individual files of data for particular fields. The data can be: either, initial values and boundary conditions that the user must specify to define the problem; or, results written to file by OpenFOAM. Note that the OpenFOAM fields must always be initialised, even when the solution does not strictly require it, as in steady-state problems. The name of each time directory is based on the simulated time at which the data is written and is described fully in [section 4.3](#). It is sufficient to say now that since we usually start our simulations at time  $t = 0$ , the initial conditions are usually stored in a directory named *0* or *0.000000e+00*, depending on the name format specified. For example, in the cavity tutorial, the velocity field  $\mathbf{U}$  and pressure field  $p$  are initialised from files *0/U* and *0/p* respectively.

## 4.2 Basic input/output file format

OpenFOAM needs to read a range of data structures such as strings, scalars, vectors, tensors, lists and fields. The input/output (I/O) format of files is designed to be extremely flexible to enable the user to modify the I/O in OpenFOAM applications as easily as possible. The I/O follows a simple set of rules that make the files extremely easy to understand, in contrast to many software packages whose file format may not only be difficult to understand intuitively but also not be published anywhere. The description of the OpenFOAM file format is described in the following sections.

### 4.2.1 General syntax rules

The format follows the following some general principles of C++ source code.

- Files have free form, with no particular meaning assigned to any column and no need to indicate continuation across lines.
- Lines have no particular meaning except to a `//` comment delimiter which makes OpenFOAM ignore any text that follows it until the end of line.
- A comment over multiple lines is done by enclosing the text between `/*` and `*/` delimiters.

### 4.2.2 Dictionaries

OpenFOAM uses *dictionaries* as the most common means of specifying data. A dictionary is an entity that contains a set data entries that can be retrieved by the I/O by means of *keywords*. The keyword entries follow the general format

```
<keyword> <dataEntry1> ... <dataEntryN>;
```

Most entries are single data entries of the form:

```
<keyword> <dataEntry>;
```

Most OpenFOAM data files are themselves dictionaries containing a set of keyword entries. Dictionaries provide the means for organising entries

```
25     relTol      0;
26   }
27
28   U
29   {
30     solver      PBiCG;
31     preconditioner DILU;
32     tolerance   1e-05;
33     relTol      0;
34   }
35 }
36
37 PISO
38 {
39   nCorrectors      2;
40   nNonOrthogonalCorrectors 0;
41   pRefCell         0;
42   pRefValue        0;
43 }
44
45 // ***** //
46
```

## 4.2.4 Lists

OpenFOAM applications contain lists, *e.g.* a list of vertex coordinates for a mesh description. Lists are commonly found in I/O and have a format of t



### 4.2.5 Scalars, vectors and tensors

A scalar is a single number represented as such in a data file. A vector is a `VectorSpace` of rank 1 and dimension 3, and since the number of elements is always fixed to 3, the simple List format is used. Therefore a vector (1.0, 1.1, 1.2) is written:

```
(1.0 1.1 1.2)
```

In OpenFOAM, a tensor is a `VectorSpace` of rank 2 and dimension 3 and therefore the data entries are always fixed to 9 real numbers. Therefore the identity tensor, described in [section 1.3.7](#) of the Programmer's Guide, can be written:

```
(
  1 0 0
  0 1 0
  0 0 1
)
```

This example demonstrates the way in which OpenFOAM ignores the line return is so that the entry can be written over multiple lines. It is treated no differently to listing the numbers on a single line:

```
( 1 0 0 0 1 0 0 0 1 )
```

### 4.2.6 Dimensional units

In continuum mechanics, properties are represented in some chosen units, *e.g.* mass in kilograms (kg), volume in cubic metres (m<sup>3</sup>), pressure in Pascals (kg m<sup>-1</sup> s<sup>-2</sup>). Algebraic operations must be performed on these properties using consistent units of measurement; in particular, addition, subtraction and equality are only physically meaningful for properties of the same dimensional units. As a safeguard against implementing a meaningless operation, OpenFOAM attaches dimensions to field data and physical properties and performs dimension checking on any tensor operation.

The I/O format for a `dimensionSet` is 7 scalars delimited by square brackets, *e.g.*

```
[0 2 -1 0 0 0 0]
```

No.	Property	SI unit	USCS unit
1	Mass	kilogram (kg)	pound-mass (lbm)
2	Length	metre (m)	foot (ft)
3	Time	— — — —	second (s) — — — —
4	Temperature	Kelvin (K)	degree Rankine (°R)
5	Quantity	kilogram-mole (kgmol)	pound-mole (lbmol)
6	Current	— — — —	ampere (A) — — — —
7	Luminous intensity	— — — —	candela (cd) — — — —

Table 4.2: Base units for SI and USCS

where each of the values corresponds to the power of each of the base units of measurement listed in [Table 4.2](#). The table gives the base units for the *Système International* (SI) and the *United States Customary System* (USCS) but OpenFOAM can be used

with any system of units. All that is required is that the *input data is correct for the chosen set of units*. It is particularly important to recognise that OpenFOAM requires some dimensioned physical constants, *e.g.* the Universal Gas Constant  $R$ , for certain calculations, *e.g.* thermophysical modelling. These dimensioned constants are specified in a *DimensionedConstant* sub-dictionary of main *controlDict* file of the OpenFOAM installation ( $\$WM\_PROJECT\_DIR/etc/controlDict$ ). By default these constants are set in SI units. Those wishing to use the USCS or any other system of units should modify these constants to their chosen set of units accordingly.

### 4.2.7 Dimensioned types

Physical properties are typically specified with their associated dimensions. These entries have the format that the following example of a *dimensionedScalar* demonstrates:

```
nu          nu  [0 2 -1 0 0 0 0]  1;
```

The first *nu* is the keyword; the second *nu* is the word name stored in class *word*, usually chosen to be the same as the keyword; the next entry is the *dimensionSet* and the final entry is the *scalar* value.

### 4.2.8 Fields

Much of the I/O data in OpenFOAM are tensor fields, *e.g.* velocity, pressure data, that are read from and written into the time directories. OpenFOAM writes field data using keyword entries as described in [Table 4.3](#).

Keyword	Description	Example
<i>dimensions</i>	Dimensions of field	[1 1 -2 0 0 0 0]
<i>internalField</i>	Value of internal field	uniform (1 0 0)
<i>boundaryField</i>	Boundary field	see file listing in <a href="#">section 4.2.8</a>

Table 4.3: Main keywords used in field dictionaries.

The data begins with an entry for its *dimensions*. Following that, is the *internalField*, described in one of the following ways.

**Uniform field** a single value is assigned to all elements within the field, taking the form:

```
internalField uniform <entry>;
```

**Nonuniform field** each field element is assigned a unique value from a list, taking the following form where the token identifier form of list is recommended:

```
internalField nonuniform <List>;
```

The *boundaryField* is a dictionary containing a set of entries whose names correspond to each of the names of the boundary patches listed in the *boundary* file in the *polyMesh* directory. Each patch entry is itself a dictionary containing a list of keyword entries. The compulsory entry, *type*, describes the patch field condition specified for the field. The remaining entries correspond to the type of patch field condition selected and can

---

typically include field data specifying initial conditions on patch faces. A selection of patch field conditions available in OpenFOAM are listed in [Table 5.3](#) and [Table 5.4](#) with

```

        type fixedValue;
        value $pressure;
    }
}

```

This is a fairly trivial example that simply demonstrates how this functionality works. However, the functionality can be used in many, more powerful ways particularly as a means of generalising case data to suit the user's needs. For example, if a user has a set of cases that require the same RAS turbulence model settings, a single file can be created with those settings which is simply included in the *RASProperties* file of each case. Macro substitutions can extend well beyond a single value so that, for example, sets of boundary conditions can be predefined and called by a single macro. The extent to which such functionality can be used is almost endless.

### 4.3 Time and data input/output control

The OpenFOAM solvers begin all runs by setting up a database. The database controls I/O and, since output of data is usually requested at intervals of time during the run, time is an inextricable part of the database. The *controlDict* dictionary sets input parameters *essential* for the creation of the database. The keyword entries in *controlDict* are listed in [Table 4.4](#). Only the time control and `writeInterval` entries are truly compulsory, with the database taking default values indicated by † in [Table 4.4](#) for any of the optional entries that are omitted.

#### Time control

---

<code>startFrom</code>	Controls the start time of the simulation.
- <code>firstTime</code>	Earliest time step from the set of time directories.
- <code>startTime</code>	Time specified by the <code>startTime</code> keyword entry.
- <code>latestTime</code>	Most recent time step from the set of time directories.
<code>startTime</code>	Start time for the simulation with <code>startFrom startTime</code> ;
<code>stopAt</code>	Controls the end time of the simulation.
- <code>endTime</code>	Time specified by the <code>endTime</code> keyword entry.
- <code>writeNow</code>	Stops simulation on completion of current time step and writes data.
- <code>noWriteNow</code>	Stops simulation on completion of current time step and does not write out data.
- <code>nextWrite</code>	Stops simulation on completion of next scheduled write time, specified by <code>writeControl</code> .
<code>endTime</code>	End time for the simulation when <code>stopAt endTime</code> ; is specified.
<code>deltaT</code>	Time step of the simulation.

#### Data writing

---

<code>writeControl</code>	Controls the timing of write output to file.
- <code>timeStep†</code>	Writes data every <code>writeInterval</code> time steps.
- <code>runTime</code>	Writes data every <code>writeInterval</code> seconds of simulated time.

*Continued on next page*

*Continued from previous page*

- adjustableRunTime Writes data every `writeInterval` seconds of simulated time, adjusting the time steps to coincide with the `writeInterval` if necessary — used in cases with automatic time step adjustment.
  - cpuTime Writes data every `writeInterval` seconds of CPU time.
  - clockTime Writes data out every `writeInterval` seconds of real time.
- `writeInterval` Scalar used in conjunction with `writeControl` described above.
- `purgeWrite` Integer representing a limit on the number of time directories that are stored by overwriting time directories on a cyclic basis. Example of  $t_0 = 5\text{s}$ ,  $\Delta t = 1\text{s}$  and `purgeWrite 2`;: data written into 2 directories, 6 and 7, before returning to write the data at 8 s in 6, data at 9 s into 7, etc.  
*To disable the time directory limit, specify `purgeWrite 0`;*  
 For steady-state solutions, results from previous iterations can be continuously overwritten by specifying `purgeWrite 1`;
- `writeFormat` Specifies the format of the data files.
- `ascii`† ASCII format, written to `writePrecision` significant figures.
  - `binary` Binary format.
- `writePrecision` Integer used in conjunction with `writeFormat` described above, 6† by default
- `writeCompression` Specifies the compression of the data files.
- `uncompressed` No compression.†
  - `compressed` `gzip` compression.
- `timeFormat` Choice of format of the naming of the time directories.
- `fixed`  $\pm m.d\text{d}\text{d}\text{d}\text{d}$  where the number of *ds* is set by `timePrecision`.
  - `scientific`  $\pm m.d\text{d}\text{d}\text{d}\text{d}e\pm xx$  where the number of *ds* is set by `timePrecision`.
  - `general`† Specifies `scientific` format if the exponent is less than -4 or greater than or equal to that specified by `timePrecision`.
- `timePrecision` Integer used in conjunction with `timeFormat` described above, 6† by default
- `graphFormat` Format for graph data written by an application.
- `raw`† Raw ASCII format in columns.
  - `gnuplot` Data in `gnuplot` format.
  - `xmgr` Data in `Grace/xmgr` format.
  - `jplot` Data in `jPlot` format.

### Data reading

- 
- `runTimeModifiable` `yes`†/no switch for whether dictionaries, *e.g.* `controlDict`, are re-read by OpenFOAM at the beginning of each time step.

*Continued on next page*

*Continued from previous page*

### Run-time loadable functionality

---

<code>libs</code>	List of additional libraries (on <code>\$LD_LIBRARY_PATH</code> ) to be loaded at run-time, <i>e.g.</i> ( <code>"libUser1.so" "libUser2.so" </code> )
<code>functions</code>	List of functions, <i>e.g.</i> probes to be loaded at run-time; see examples in <code>\$FOAM_TUTORIALS</code>

---

† denotes default entry if associated keyword is omitted.

Table 4.4: Keyword entries in the *controlDict* dictionary.

Example entries from a *controlDict* dictionary are given below:

```

17
18 application    icoFoam;
19
20 startFrom      startTime;
21
22 startTime      0;
23
24 stopAt         endTime
24
```

The set of terms, for which numerical schemes must be specified, are subdivided within the *fvSchemes* dictionary into the categories listed in Table 4.5. Each keyword in Table 4.5 is the name of a sub-dictionary which contains terms of a particular type, *e.g.* `gradSchemes` contains all the gradient derivative terms such as `grad(p)` (which represents  $\nabla p$ ). Further examples can be seen in the extract from an *fvSchemes* dictionary below:

Keyword	Category of mathematical terms
<code>interpolationSchemes</code>	Point-to-point interpolations of values
<code>snGradSchemes</code>	Component of gradient normal to a cell face
<code>gradSchemes</code>	Gradient $\nabla$
<code>divSchemes</code>	Divergence $\nabla \cdot$
<code>laplacianSchemes</code>	Laplacian $\nabla^2$
<code>timeScheme</code>	First and second time derivatives $\partial/\partial t, \partial^2/\partial^2 t$
<code>fluxRequired</code>	Fields which require the generation of a flux

Table 4.5: Main keywords used in *fvSchemes*.

```

17
18 ddtSchemes
19 {
20     default          Euler;
21 }
22
23 gradSchemes
24 {
25     default          Gauss linear;
26     grad(p)          Gauss linear;
27 }
28
29 divSchemes
30 {
31     default          none;
32     div(phi,U)       Gauss linear;
33 }
34
35 laplacianSchemes
36 {
37     default          none;
38     laplacian(nu,U)  Gauss linear corrected;
39     laplacian((1|A(U)),p) Gauss linear corrected;
40 }
41
42 interpolationSchemes
43 {
44     default          linear;
45     interpolate(HbyA) linear;
46 }
47
48 snGradSchemes
49 {
50     default          corrected;
51 }
52
53 fluxRequired
54 {
55     default          no;
56     p                ;
57 }
58
59
60 // ***** //

```

The example shows that the *fvSchemes* dictionary contains the following:

- 6 ... *Schemes* subdictionaries containing keyword entries for each term specified within including: a `default` entry; other entries whose names correspond to a word identifier for the particular term specified, *e.g.* `grad(p)` for  $\nabla p$

- a *fluxRequired* sub-dictionary containing fields for which the flux is generated in the application, *e.g.* `p` in the example.

If a `default` scheme is specified in a particular `Schemes` sub-dictionary, it is assigned to all of the terms to which the sub-dictionary refers, *e.g.* specifying a `default` in *gradSchemes* sets the scheme for all gradient terms in the application, *e.g.*  $\nabla p$ ,  $\nabla \mathbf{U}$ . When a `default` is specified, it is not necessary to specify each specific term itself in that sub-dictionary, *i.e.* the entries for `grad(p)`, `grad(U)` in this example. However, if any of these terms are included, the specified scheme overrides the `default` scheme for that term.

Alternatively the user may insist on no `default` scheme by the `none` entry. In this instance the user is obliged to specify all terms in that sub-dictionary individually. Setting `default` to `none` may appear superfluous since `default` can be overridden. However, specifying `none` forces the user to specify all terms individually which can be useful to remind the user which terms are actually present in the application.

The following sections describe the choice of schemes for each of the categories of terms in [Table 4.5](#).

#### 4.4.1 Interpolation schemes

The *interpolationSchemes* sub-dictionary contains terms that are interpolations of values typically from cell centres to face centres. A *selection* of interpolation schemes in OpenFOAM are listed in [Table 4.6](#), being divided into 4 categories: 1 category of general schemes; and, 3 categories of schemes used primarily in conjunction with Gaussian discretisation of convection (divergence) terms in fluid flow, described in [section 4.4.5](#). It is *highly unlikely* that the user would adopt any of the convection-specific schemes for general field interpolations in the *interpolationSchemes* sub-dictionary, but, as valid interpolation schemes, they are described here rather than in [section 4.4.5](#). Note that additional schemes such as UMIST are available in OpenFOAM but only those schemes that are generally recommended are listed in [Table 4.6](#).

A general scheme is simply specified by quoting the keyword and entry, *e.g.* a `linear` scheme is specified as `default` by:

```
default linear;
```

The convection-specific schemes calculate the interpolation based on the flux of the flow velocity. The specification of these schemes requires the name of the flux field on which the interpolation is based; in most OpenFOAM applications this is `phi`, the name commonly adopted for the `surfaceScalarField` velocity flux  $\phi$ . The 3 categories of convection-specific schemes are referred to in this text as: general convection; normalised variable (NV); and, total variation diminishing (TVD). With the exception of the `blended` scheme, the general convection and TVD schemes are specified by the scheme and flux, *e.g.* an `upwind` scheme based on a flux `phi` is specified as `default` by:

```
default upwind phi;
```

Some TVD/NVD schemes require a coefficient  $\psi$ ,  $0 \leq \psi \leq 1$  where  $\psi = 1$  corresponds to TVD conformance, usually giving best convergence and  $\psi = 0$  corresponds to best accuracy. Running with  $\psi = 1$  is generally recommended. A `limitedLinear` scheme based on a flux `phi` with  $\psi = 1.0$  is specified as `default` by:

```
default limitedLinear 1.0 phi;
```



#### 4.4.1.1 Schemes for strictly bounded scalar fields

There are enhanced versions of some of the limited schemes for scalars that need to be strictly bounded. To bound between user-specified limits, the scheme name should be prepended by the word `limited` and followed by the lower and upper limits respectively. For example, to bound the `vanLeer` scheme strictly between -2 and 3, the user would specify:

```
default limitedVanLeer -2.0 3.0;
```

There are specialised versions of these schemes for scalar fields that are commonly bounded between 0 and 1. These are selected by adding 01 to the name of the scheme. For example, to bound the `vanLeer` scheme strictly between 0 and 1, the user would specify:

```
default vanLeer01;
```

Strictly bounded versions are available for the following schemes: `limitedLinear`, `vanLeer`, `Gamma`, `limitedCubic`, `MUSCL` and `SuperBee`.

#### 4.4.1.2 Schemes for vector fields

There are improved versions of some of the limited schemes for vector fields in which the limited is formulated to take into account the direction of the field. These schemes are selected by adding V to the name of the general scheme, *e.g.* `limitedLinearV` for `limitedLinear`. ‘V’ versions are available for the following schemes: `limitedLinearV`, `vanLeerV`, `GammaV`, `limitedCubicV` and `SFCDV`.

Centred schemes	
<code>linear</code>	Linear interpolation (central differencing)
<code>cubicCorrection</code>	Cubic scheme
<code>midPoint</code>	Linear interpolation with symmetric weighting
Upwinded convection schemes	
<code>upwind</code>	Upwind differencing
<code>linearUpwind</code>	Linear upwind differencing
<code>skewLinear</code>	Linear with skewness correction
<code>QUICK</code>	Quadratic upwind differencing
TVD schemes	
<code>limitedLinear</code>	limited linear differencing
<code>vanLeer</code>	van Leer limiter
<code>MUSCL</code>	MUSCL limiter
<code>limitedCubic</code>	Cubic limiter
NVD schemes	
<code>SFCD</code>	Self-filtered central differencing
<code>Gamma <math>\psi</math></code>	Gamma differencing

Table 4.6: Interpolation schemes.

## 4.4.2 Surface normal gradient schemes

The *snGradSchemes* sub-dictionary contains surface normal gradient terms. A surface normal gradient is evaluated at a cell face; it is the component, normal to the face, of the gradient of values at the centres of the 2 cells that the face connects. A surface normal gradient may be specified in its own right and is also required to evaluate a Laplacian term using Gaussian integration.

The available schemes are listed in [Table 4.7](#) and are specified by simply quoting the keyword and entry, with the exception of `limited` which requires a coefficient  $\psi$ ,  $0 \leq \psi \leq 1$  where

$$\psi = \begin{cases} 0 & \text{corresponds to } \text{uncorrected}, \\ 0.333 & \text{non-orthogonal correction} \leq 0.5 \times \text{orthogonal part}, \\ 0.5 & \text{non-orthogonal correction} \leq \text{orthogonal part}, \\ 1 & \text{corresponds to } \text{corrected}. \end{cases} \quad (4.1)$$

A `limited` scheme with  $\psi = 0.5$  is therefore specified as `default` by:

```
default limited 0.5;
```

Scheme	Description
<code>corrected</code>	Explicit non-orthogonal correction
<code>uncorrected</code>	No non-orthogonal correction
<code>limited <math>\psi</math></code>	Limited non-orthogonal correction
<code>bounded</code>	Bounded correction for positive scalars
<code>fourth</code>	Fourth order

Table 4.7: Surface normal gradient schemes.

## 4.4.3 Gradient schemes

The *gradSchemes* sub-dictionary contains gradient terms. The discretisation scheme for each term can be selected from those listed in [Table 4.8](#).

Discretisation scheme	Description
<code>Gauss &lt;interpolationScheme&gt;</code>	Second order, Gaussian integration
<code>leastSquares</code>	Second order, least squares
<code>fourth</code>	Fourth order, least squares
<code>limited &lt;gradScheme&gt;</code>	Limited version of one of the above schemes

Table 4.8: Discretisation schemes available in *gradSchemes*.

The discretisation scheme is sufficient to specify the scheme completely in the cases of `leastSquares` and `fourth`, *e.g.*

```
grad(p) leastSquares;
```

The **Gauss** keyword specifies the standard finite volume discretisation of Gaussian integration which requires the interpolation of values from cell centres to face centres. Therefore, the **Gauss** entry must be followed by the choice of interpolation scheme from [Table 4.6](#). It would be extremely unusual to select anything other than general interpolation schemes and in most cas(u)-0.342058(s).59 -14.4449 Td [(l)0.218o9gsassa

```
Gauss <interpolationScheme>
```

The interpolation scheme is selected from the full range of schemes in [Table 4.6](#), both general and convection-specific. The choice critically determines numerical behaviour as described in [Table 4.10](#). The syntax here for specifying convection-specific interpolation schemes *does not include the flux* as it is already known for the particular term, *i.e.* for `div(phi,U)`, we know the flux is `phi` so specifying it in the interpolation scheme would only invite an inconsistency. Specification of upwind interpolation in our example would therefore be:

```
div(phi,U) Gauss upwind;
```

Scheme	Numerical behaviour
<code>linear</code>	Second order, unbounded
<code>skewLinear</code>	Second order, (more) unbounded, skewness correction
<code>cubicCorrected</code>	Fourth order, unbounded
<code>upwind</code>	First order, bounded
<code>linearUpwind</code>	First/second order, bounded
<code>QUICK</code>	First/second order, bounded
TVD schemes	First/second order, bounded
SFCD	Second order, bounded
NVD schemes	First/second order, bounded

Table 4.10: Behaviour of interpolation schemes used in *divSchemes*.

#### 4.4.6 Time schemes

The first time derivative ( $\partial/\partial t$ ) terms are specified in the *ddtSchemes* sub-dictionary. The discretisation scheme for each term can be selected from those listed in [Table 4.11](#).

There is an off-centering coefficient  $\psi$  with the `CrankNicholson` scheme that blends it with the `Euler` scheme. A coefficient of  $\psi = 1$  corresponds to pure `CrankNicholson` and  $\psi = 0$  corresponds to pure `Euler`. The blending coefficient can help to improve stability in cases where pure `CrankNicholson` are unstable.

Scheme	Description
<code>Euler</code>	First order, bounded, implicit
<code>CrankNicholson <math>\psi</math></code>	Second order, bounded, implicit
<code>backward</code>	Second order, implicit
<code>steadyState</code>	Does not solve for time derivatives

Table 4.11: Discretisation schemes available in *ddtSchemes*.

When specifying a time scheme it must be noted that an application designed for transient problems will not necessarily run as steady-state and visa versa. For example the solution will not converge if `steadyState` is specified when running `icoFoam`, the transient, laminar incompressible flow code; rather, `simpleFoam` should be used for steady-state, incompressible flow.

Any second time derivative ( $\partial^2/\partial t^2$ ) terms are specified in the *d2dt2Schemes* sub-dictionary. Only the `Euler` scheme is available for *d2dt2Schemes*.

### 4.4.7 Flux calculation

The *fluxRequired* sub-dictionary lists the fields for which the flux is generated in the application. For example, in many fluid dynamics applications the flux is generated after solving a pressure equation, in which case the *fluxRequired* sub-dictionary would simply be entered as follows, *p* being the *word* identifier for pressure:

```
fluxRequired
{
    p;
}
```

## 4.5 Solution and algorithm control

The equation solvers, tolerances and algorithms are controlled from the *fvSolution* dictionary in the *system* directory. Below is an example set of entries from the *fvSolution* dictionary required for the *icoFoam* solver.

```
17
18 solvers
19 {
20     p
21     {
22         solver          PCG;
23         preconditioner  DIC;
24         tolerance       1e-06;
25         relTol          0;
26     }
27
28     U
29     {
30         solver          PBiCG;
31         preconditioner  DILU;
32         tolerance       1e-05;
33         relTol          0;
34     }
35 }
36
37 PISO
38 {
39     nCorrectors          2;
40     nNonOrthogonalCorrectors 0;
41     pRefCell             0;
42     pRefValue            0;
43 }
44
45
46 // ***** //
```

*fvSolution* contains a set of subdictionaries that are specific to the solver being run. However, there is a small set of standard subdictionaries that cover most of those used by the standard solvers. These subdictionaries include *solvers*, *relaxationFactors*, *PISO* and *SIMPLE* which are described in the remainder of this section.

### 4.5.1 Linear solver control

The first sub-dictionary in our example, and one that appears in all solver applications, is *solvers*. It specifies each linear-solver that is used for each discretised equation; it is emphasised that the term *linear-solver* refers to the method of number-crunching to solve the set of linear equations, as opposed to *application* solver which describes the set of equations and algorithms to solve a particular problem. The term ‘linear-solver’ is abbreviated to ‘solver’ in much of the following discussion; we hope the context of the term avoids any ambiguity.

The syntax for each entry within *solvers* uses a keyword that is the word relating to the variable being solved in the particular equation. For example, `icoFoam` solves equations for velocity  $\mathbf{U}$  and pressure  $p$ , hence the entries for  $\mathbf{U}$  and  $p$ . The keyword is followed by a dictionary containing the type of solver and the parameters that the solver uses. The solver is selected through the `solver` keyword from the choice in OpenFOAM, listed in Table 4.12. The parameters, including `tolerance`, `relTol`, `preconditioner`, *etc.* are described in following sections.

Solver	Keyword
Preconditioned (bi-)conjugate gradient	PCG/PBiCG†
Solver using a smoother	<code>smoothSolver</code>
Generalised geometric-algebraic multi-grid	GAMG

†PCG for symmetric matrices, PBiCG for asymmetric

Table 4.12: Linear solvers.

The solvers distinguish between symmetric matrices and asymmetric matrices. The symmetry of the matrix depends on the structure of the equation being solved and, while the user may be able to determine this, it is not essential since OpenFOAM will produce an error message to advise the user if an inappropriate solver has been selected, *e.g.*

```
--> FOAM FATAL IO ERROR : Unknown asymmetric matrix solver PCG
Valid asymmetric matrix solvers are :
3
(
PBiCG
smoothSolver
GAMG
)
```

#### 4.5.1.1 Solution tolerances

The sparse matrix solvers are iterative, *i.e.* they are based on reducing the equation residual over a succession of solutions. The residual is ostensibly a measure of the error in the solution so that the smaller it is, the more accurate the solution. More precisely, the residual is evaluated by substituting the current solution into the equation and taking the magnitude of the difference between the left and right hand sides; it is also normalised in to make it independent of the scale of problem being analysed.

Before solving an equation for a particular field, the initial residual is evaluated based on the current values of the field. After each solver iteration the residual is re-evaluated. The solver stops if *either* of the following conditions are reached:

- the residual falls below the *solver tolerance*, `tolerance`;
- the ratio of current to initial residuals falls below the *solver relative tolerance*, `relTol`;

The solver tolerance should represents the level at which the residual is small enough that the solution can be deemed sufficiently accurate. The solver relative tolerance limits the relative improvement from initial to final solution. It is quite common to set the solver relative tolerance to 0 to force the solution to converge to the solver tolerance. The tolerances, `tolerance` and `relTol` must be specified in the dictionaries for all solvers.

### 4.5.1.2 Preconditioned conjugate gradient solvers

There are a range of options for preconditioning of matrices in the conjugate gradient solvers, represented by the `preconditioner` keyword in the solver dictionary. The preconditioners are listed in [Table 4.13](#).

Preconditioner	Keyword
Diagonal incomplete-Cholesky (symmetric)	DIC
Faster diagonal incomplete-Cholesky (DIC with caching)	FDIC
Diagonal incomplete-LU (asymmetric)	DILU
Diagonal	diagonal
Geometric-algebraic multi-grid	GAMG
No preconditioning	none

Table 4.13: Preconditioner options.

### 4.5.1.3 Smooth solvers

The solvers that use a smoother require the smoother to be specified. The smoother options are listed in [Table 4.14](#). Generally `GaussSeidel` is the most reliable option, but for bad matrices DIC can offer better convergence. In some cases, additional post-smoothing using `GaussSeidel` is further beneficial, *i.e.* the method denoted as `DICGaussSeidel`

Smoother	Keyword
Gauss-Seidel	<code>GaussSeidel</code>
Diagonal incomplete-Cholesky (symmetric)	DIC
Diagonal incomplete-Cholesky with Gauss-Seidel (symmetric)	<code>DICGaussSeidel</code>

Table 4.14: Smoother options.

The user must also specify the number of sweeps, by the `nSweeps` keyword, before the residual is recalculated, following the tolerance parameters.

### 4.5.1.4 Geometric-algebraic multi-grid solvers

The generalised method of geometric-algebraic multi-grid (GAMG) uses the principle of: generating a quick solution on a mesh with a small number of cells; mapping this solution onto a finer mesh; using it as an initial guess to obtain an accurate solution on the fine mesh. GAMG is faster than standard methods when the increase in speed by solving first on coarser meshes outweighs the additional costs of mesh refinement and mapping of field data. In practice, GAMG starts with the mesh specified by the user and coarsens/refines the mesh in stages. The user is only required to specify an approximate mesh size at the most coarse level in terms of the number of cells `nCoarsestCells`.

The agglomeration of cells is performed by the algorithm specified by the `agglomerator` keyword. Presently we recommend the `faceAreaPair` method. It is worth noting there is an `MGridGen` option that requires an additional entry specifying the shared object library for `MGridGen`:

```
geometricGangAgglomerationLibs ("libMGridGenGangAgglomeration.so");
```

In the experience of OpenCFD, the [MGridGen](#) method offers no obvious benefit over the `faceAreaPair` method. For all methods, agglomeration can be optionally cached by the `cacheAgglomeration` switch.

Smoothing is specified by the `smoother` as described in [section 4.5.1.3](#). The number of sweeps used by the smoother at different levels of mesh density are specified by the `nPreSweeps`, `nPostSweeps` and `nFinestSweeps` keywords. The `nPreSweeps` entry is used as the algorithm is coarsening the mesh, `nPostSweeps` is used as the algorithm is refining, and `nFinestSweeps` is used when the solution is at its finest level.

The `mergeLevels` keyword controls the speed at which coarsening or refinement levels is performed. It is often best to do so only at one level at a time, *i.e.* set `mergeLevels` 1. In some cases, particularly for simple meshes, the solution can be safely speeded up by coarsening/refining two levels at a time, *i.e.* setting `mergeLevels` 2.

## 4.5.2 Solution under-relaxation

A second sub-dictionary of `fvSolution` that is often used in OpenFOAM is `relaxationFactors` which controls under-relaxation, a technique used for improving stability of a computation, particularly in solving steady-state problems. Under-relaxation works by limiting the amount which a variable changes from one iteration to the next, either by modifying the solution matrix and source prior to solving for a field or by modifying the field directly. An under-relaxation factor  $\alpha$ ,  $0 < \alpha \leq 1$  specifies the amount of under-relaxation, ranging from none at all for  $\alpha = 1$  and increasing in strength as  $\alpha \rightarrow 0$ . The limiting case where  $\alpha = 0$  represents a solution which does not change at all with successive iterations. An optimum choice of  $\alpha$  is one that is small enough to ensure stable computation but large enough to move the iterative process forward quickly; values of  $\alpha$  as high as 0.9 can ensure stability in some cases and anything much below, say, 0.2 are prohibitively restrictive in slowing the iterative process.

The user can specify the relaxation factor for a particular field by specifying first the word associated with the field, then the factor. The user can view the relaxation factors used in a tutorial example of `simpleFoam` for incompressible, laminar, steady-state flows.

```

17
18 solvers
19 {
20     p
21     {
22         solver          PCG;
23         preconditioner  DIC;
24         tolerance       1e-06;
25         relTol          0.01;
26     }
27
28     U
29     {
30         solver          PBiCG;
31         preconditioner  DILU;
32         tolerance       1e-05;
33         relTol          0.1;
34     }
35
36     k
37     {
38         solver          PBiCG;
39         preconditioner  DILU;
40         tolerance       1e-05;
41         relTol          0.1;
42     }
43
44     epsilon
45     {
46         solver          PBiCG;
47         preconditioner  DILU;
48         tolerance       1e-05;
49         relTol          0.1;
50     }

```



```

51
52     R
53     {
54         solver          PBiCG;
55         preconditioner  DILU;
56         tolerance       1e-05;
57         relTol          0.1;
58     }
59
60     nuTilda
61     {
62         solver          PBiCG;
63         preconditioner  DILU;
64         tolerance       1e-05;
65         relTol          0.1;
66     }
67 }
68
69 SIMPLE
70 {
71     nNonOrthogonalCorrectors 0;
72 }
73
74 relaxationFactors
75 {
76     p          0.3;
77     U          0.7;
78     k          0.7;
79     epsilon    0.7;
80     R          0.7;
81     nuTilda    0.7;
82 }
83
84
85 // ***** //

```

### 4.5.3 PISO and SIMPLE algorithms

Most fluid dynamics solver applications in OpenFOAM use the pressure-implicit split-operator (PISO) or semi-implicit method for pressure-linked equations (SIMPLE) algorithms. These algorithms are iterative procedures for solving equations for velocity and pressure, PISO being used for transient problems and SIMPLE for steady-state.

Both algorithms are based on evaluating some initial solutions and then correcting them. SIMPLE only makes 1 correction whereas PISO requires more than 1, but typically not more than 4. The user must therefore specify the number of correctors in the PISO dictionary by the `nCorrectors` keyword as shown in the example on page U-117.

An additional correction to account for mesh non-orthogonality is available in both SIMPLE and PISO in the standard OpenFOAM solver applications. A mesh is orthogonal if, for each face within it, the face normal is parallel to the vector between the centres of the cells that the face connects, *e.g.* a mesh of hexahedral cells whose faces are aligned with a Cartesian coordinate system. The number of non-orthogonal correctors is specified by the `nNonOrthogonalCorrectors` keyword as shown in the examples above and on page U-117. The number of non-orthogonal correctors should correspond to the mesh for the case being solved, *i.e.* 0 for an orthogonal mesh and increasing with the degree of non-orthogonality up to, say, 20 for the most non-orthogonal meshes.

#### 4.5.3.1 Pressure referencing

In a closed incompressible system, pressure is relative: it is the pressure range that matters not the absolute values. In these cases, the solver sets a reference level of `pRefValue` in cell `pRefCell` where `p` is the name of the pressure solution variable. Where the pressure is `pd`, the names are `pdRefValue` and `pdRefCell` respectively. These entries are generally stored in the *PISO/SIMPLE* sub-dictionary and are used by those solvers that require them when the case demands it. If omitted, the solver will not run, but give a message to alert the user to the problem.

#### 4.5.4 Other parameters

The *fvSolutions* dictionaries in the majority of standard OpenFOAM solver applications contain no other entries than those described so far in this section. However, in general the *fvSolution* dictionary may contain any parameters to control the solvers, algorithms, or in fact anything. For a given solver, the user can look at the source code to find the parameters required. Ultimately, if any parameter or sub-dictionary is missing when an solver is run, it will terminate, printing a detailed error message. The user can then add missing parameters accordingly.

# Chapter 5

## Mesh generation and conversion

This chapter describes all topics relating to the creation of meshes in OpenFOAM: [section 5.1](#) gives an overview of the ways a mesh may be described in OpenFOAM; [section 5.3](#) covers the `blockMesh` utility for generating simple meshes of blocks of hexahedral cells; [section 5.4](#) covers the `snappyHexMesh` utility for generating complex meshes of hexahedral and split-hexahedral cells automatically from triangulated surface geometries; [section 5.5](#) describes the options available for conversion of a mesh that has been generated by a third-party product into a format that OpenFOAM can read.

### 5.1 Mesh description

This section provides a specification of the way the OpenFOAM C++ classes handle a mesh. The mesh is an integral part of the numerical solution and must satisfy certain criteria to ensure a valid, and hence accurate, solution. During any run, OpenFOAM checks that the mesh satisfies a fairly stringent set of validity constraints and will cease running if the constraints are not satisfied. The consequence is that a user may experience some frustration in ‘correcting’ a large mesh generated by third-party mesh generators before OpenFOAM will run using it. This is unfortunate but we make no apology for OpenFOAM simply adopting good practice to ensure the mesh is valid; otherwise, the solution is flawed before the run has even begun.

By default OpenFOAM defines a mesh of arbitrary polyhedral cells in 3-D, bounded by arbitrary polygonal faces, *i.e.* the cells can have an unlimited number of faces where, for each face, there is no limit on the number of edges nor any restriction on its alignment. A mesh with this general structure is known in OpenFOAM as a `polyMesh`. It is described in further detail in [section 2.3](#) of the Programmer’s Guide, but it is sufficient to mention here that this type of mesh offers great freedom in mesh generation and manipulation in particular when the geometry of the domain is complex or changes over time. The price of absolute mesh generality is, however, that it can be difficult to convert meshes generated using conventional tools. The OpenFOAM library therefore provides `cellShape` tools to manage conventional mesh formats based on sets of pre-defined cell shapes.

#### 5.1.1 Mesh specification and validity constraints

Before describing the OpenFOAM mesh format, `polyMesh`, and the `cellShape` tools, we will first set out the validity constraints used in OpenFOAM. The conditions that a mesh must satisfy are:

### 5.1.1.1 Points

A point is a location in 3-D space, defined by a vector in units of metres (m). The points are compiled into a list and each point is referred to by a label, which represents its position in the list, starting from zero. *The point list cannot contain two different points at an exactly identical position nor any point that is not part at least one face.*

### 5.1.1.2 Faces

A face is an ordered list of points, where a point is referred to by its label. The ordering of point labels in a face is such that each two neighbouring points are connected by an edge, *i.e.* you follow points as you travel around the circumference of the face. Faces are compiled into a list and each face is referred to by its label, representing its position in the list. The direction of the face normal vector is defined by the right-hand rule, *i.e.* looking towards a face, if the numbering of the points follows an anti-clockwise path, the normal vector points towards you, as shown in [Figure 5.1](#).

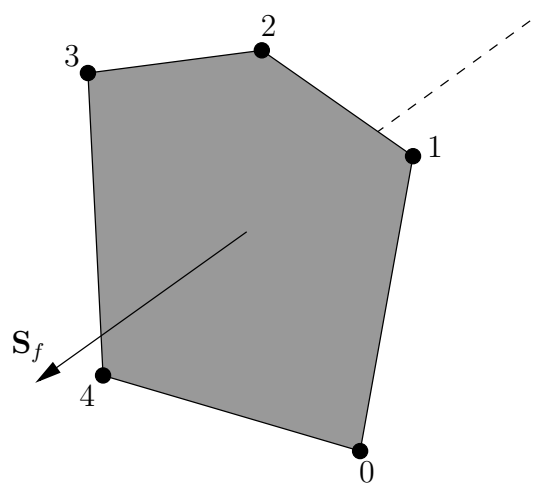

Figure 5.1: Face area vector from point numbering on the face

There are two types of face:

**Internal faces** Those faces that connect two cells (and it can never be more than two).

For each internal face, the ordering of the point labels is such that the face normal points into the cell with the larger label, *i.e.* for cells 2 and 5, the normal points into 5;

**Boundary faces** Those belonging to one cell since they coincide with the boundary of the domain. A boundary face is therefore addressed by one cell(only) and a boundary patch. The ordering of the point labels is such that the face normal points outside of the computational domain.

Faces are generally expected to be convex; at the very least the face centre needs to be inside the face. Faces are allowed to be warped, *i.e.* not all points of the face need to be coplanar.

### 5.1.1.3 Cells

A cell is a list of faces in arbitrary order. Cells must have the properties listed below.

**Contiguous** The cells must completely cover the computational domain and are must not overlap one another.

**Convex** Every cell must be convex and its cell centre inside the cell.

**Closed** Every cell must be *closed*, both geometrically and topologically where:

- geometrical closedness requires that when all face area vectors are oriented to point outwards of the cell, their sum should equal the zero vector to machine accuracy;
- topological closedness requires that all the edges in a cell are used by exactly two faces of the cell in question.

**Orthogonality** For all internal faces of the mesh, we define the centre-to-centre vector as that connecting the centres of the 2 cells that it adjoins oriented from the the centre of the cell with smaller label to the centre of the cell with larger label. The orthogonality constraint requires that for each internal face, the angle between the face area vector, oriented as described above, and the centre-to-centre vector must always be less than  $90^\circ$ .

#### 5.1.1.4 Boundary

A boundary is a list of patches, each of which is associated with a boundary condition. A patch is a list of face labels which clearly must contain only boundary faces and no internal faces. The boundary is required to be closed, *i.e.* the sum all boundary face area vectors equates to zero to machine tolerance.

### 5.1.2 The polyMesh description

The *constant* directory contains a full description of the case **polyMesh** in a subdirectory *polyMesh*. The **polyMesh** description is based around faces and, as already discussed, internal cells connect 2 cells and boundary faces address a cell and a boundary patch. Each face is therefore assigned an ‘owner’ cell and ‘neighbour’ cell so that the connectivity across a given face can simply be described by the owner and neighbour cell labels. In the case of boundaries, the connected cell is the owner and the neighbour is assigned the label ‘-1’. With this in mind, the I/O specification consists of the following files:

*points* a list of vectors describing the cell vertices, where the first vector in the list represents vertex 0, the second vector represents vertex 1, *etc.*;

*faces* a list of faces, each face being a list of indices to vertices in the points list, where again, the first entry in the list represents face 0, *etc.*;

*owner* a list of owner cell labels, the index of entry relating directly to the index of the face, so that the first entry in the list is the owner label for face 0, the second entry is the owner label for face 1, etc;

*neighbour* a list of neighbour cell labels;

*boundary* a list of patches, containing a dictionary entry for each patch, declared using the patch name, *e.g.*

```
movingWall
{
    type patch;
    nFaces 20;
    startFace 760;
```

```
}
```

The `startFace` is the index into the face list of the first face in the patch, and `nFaces` is the number of faces in the patch.

*Note that if the user wishes to know how many cells are in their domain, there is a note in the FoamFile header of the owner file that contains an entry for `nCells`.*

### 5.1.3 The cellShape tools

We shall describe the alternative `cellShape` tools that may be used particularly when converting some standard (simpler) mesh formats for the use with OpenFOAM library.

The vast majority of mesh generators and post-processing systems support only a fraction of the possible polyhedral cell shapes in existence. They define a mesh in terms of a limited set of 3D cell geometries, referred to as *cell shapes*. The OpenFOAM library contains definitions of these standard shapes, to enable a conversion of such a mesh into the `polyMesh` format described in the previous section.

The `cellShape` models supported by OpenFOAM are shown in [Table 5.1](#). The shape is defined by the ordering of point labels in accordance with the numbering scheme contained in the shape model. The ordering schemes for points, faces and edges are shown in [Table 5.1](#). The numbering of the points must not be such that the shape becomes twisted or degenerate into other geometries, *i.e.* the same point label cannot be used more than once in a single shape. Moreover it is unnecessary to use duplicate points in OpenFOAM since the available shapes in OpenFOAM cover the full set of degenerate hexahedra.

The cell description consists of two parts: the name of a cell model and the ordered list of labels. Thus, using the following list of points

```
8
(
  (0 0 0)
  (1 0 0)
  (1 1 0)
  (0 1 0)
  (0 0 0.5)
  (1 0 0.5)
  (1 1 0.5)
  (0 1 0.5)
)
```

A hexahedral cell would be written as:

```
(hex 8(0 1 2 3 4 5 6 7))
```

Here the hexahedral cell shape is declared using the keyword `hex`. Other shapes are described by the keywords listed in [Table 5.1](#).

### 5.1.4 1- and 2-dimensional and axi-symmetric problems

OpenFOAM is designed as a code for 3-dimensional space and defines all meshes as such. However, 1- and 2- dimensional and axi-symmetric problems can be simulated in OpenFOAM by generating a mesh in 3 dimensions and applying special boundary conditions on any patch in the plane(s) normal to the direction(s) of interest. More specifically, 1- and 2- dimensional problems use the `empty` patch type and axi-symmetric problems use the `wedge` type. The use of both are described in [section 5.2.2](#) and the generation of wedge geometries for axi-symmetric problems is discussed in [section 5.3.3](#).







Cell type	Keyword	Vertex numbering	Face numbering	Edge numbering
Hexahedron	hex			
				
Wedge	wedge			
				
Prism	prism			
				
Pyramid	pyr			
				
Tetrahedron	tet			
Tet-wedge	tetWedge			

Table 5.1: Vertex, face and edge numbering for cellShapes.

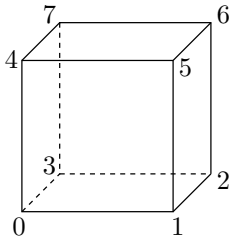
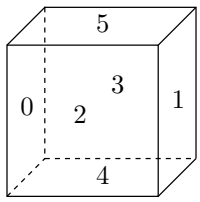
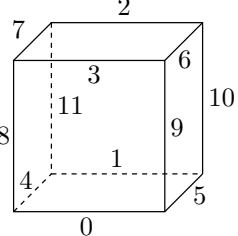
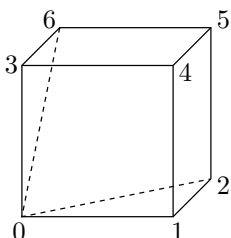
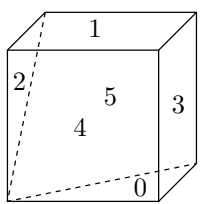
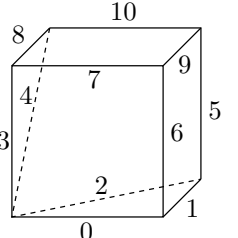
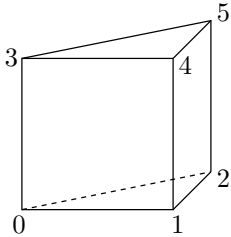
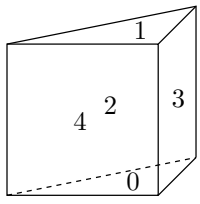
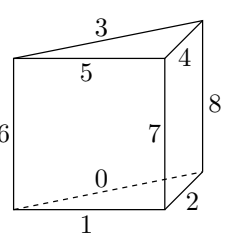
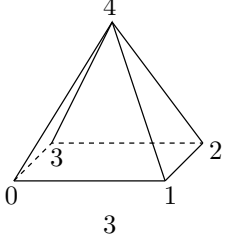
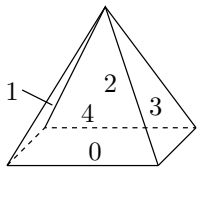
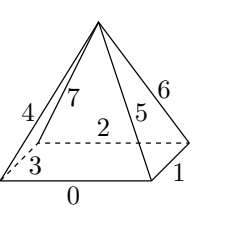
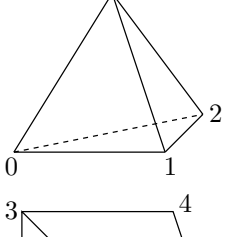
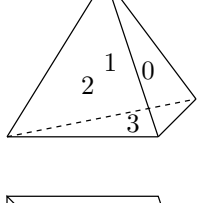
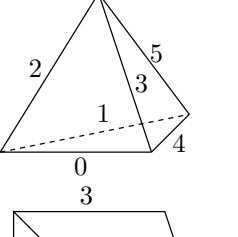
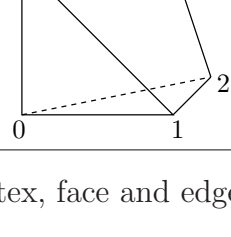
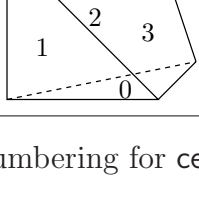
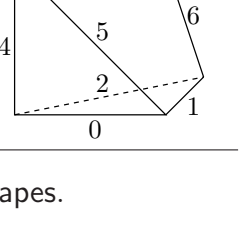
## 5.2 Boundaries

In this section we discuss the way in which boundaries are treated in OpenFOAM. The subject of boundaries is a little involved because their role in modelling is not simply that of a geometric entity but an integral part of the solution and numerics through boundary conditions or inter-boundary ‘connections’. A discussion of boundaries sits uncomfortably between a discussion on meshes, fields, discretisation, computational processing *etc.* Its placement in this Chapter on meshes is a choice of convenience.

We first need to consider that, for the purpose of applying boundary conditions, a boundary is generally broken up into a set of *patches*. One patch may include one or more enclosed areas of the boundary surface which do not necessarily need to be physically connected.

There are three attributes associated with a patch that are described below in their natural hierarchy and [Figure 5.2](#) shows the names of different patch types introduced at each level of the hierarchy. The hierarchy described below is very similar, but not identical, to the class hierarchy used in the OpenFOAM library.

**Base type** The type of patch described purely in terms of geometry or a data ‘communication link’.

**Primitive type** The base numerical patch condition assigned to a field variable on the patch.

**Derived type** A complex patch condition, derived from the primitive type, assigned to a field variable on the patch.

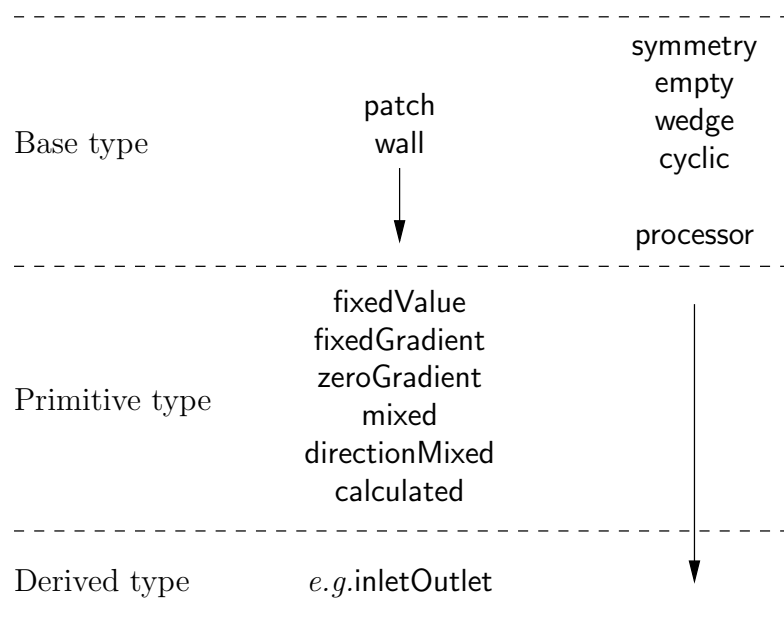

Figure 5.2: Patch attributes

### 5.2.1 Specification of patch types in OpenFOAM

The patch types are specified in the mesh and field files of a OpenFOAM case. More precisely:

- the base type is specified under the `type` keyword for each patch in the *boundary* file, located in the *constant/polyMesh* directory;



- the numerical patch type, be it a primitive or derived type, is specified under the `type` keyword for each patch in a field file.

An example *boundary* file is shown below for a sonicFoam case, followed by a pressure field file, *p*, for the same case:

```

17
18 6
19 (
20     inlet
21     {
22         type            patch;
23         nFaces          50;
24         startFace      10325;
25     }
26     outlet
27     {
28         type            patch;
29         nFaces          40;
30         startFace      10375;
31     }
32     bottom
33     {
34         type            symmetryPlane;
35         nFaces          25;
36         startFace      10415;
37     }
38     top
39     {
40         type            symmetryPlane;
41         nFaces          125;
42         startFace      10440;
43     }
44     obstacle
45     {
46         type            patch;
47         nFaces          110;
48         startFace      10565;
49     }
50     defaultFaces
51     {
52         type            empty;
53         nFaces          10500;
54         startFace      10675;
55     }
56 )
57 // ***** //
58
17 dimensions      [1 -1 -2 0 0 0];
18
19 internalField   uniform 1;
20
21 boundaryField
22 {
23     inlet
24     {
25         type            fixedValue;
26         value           uniform 1;
27     }
28
29     outlet
30     {
31         type            waveTransmissive;
32         field           p;
33         phi             phi;
34         rho             rho;
35         psi             psi;
36         gamma          1.4;
37         fieldInf       1;
38         lInf           3;
39         value          uniform 1;
40     }
41
42     bottom
43     {
44         type            symmetryPlane;
45     }
46
47     top
48     {
49         type            symmetryPlane;
50     }

```

```

51
52     obstacle
53     {
54         type            zeroGradient;
55     }
56
57     defaultFaces
58     {
59         type            empty;
60     }
61 }
62
63 // ***** //

```

The `type` in the boundary file is `patch` for all patches except those that patches that have some geometrical constraint applied to them, *i.e.* the `symmetryPlane` and `empty` patches. The `p` file includes primitive types applied to the `inlet` and `bottom` faces, and a more complex derived type applied to the `outlet`. Comparison of the two files shows that the base and numerical types are consistent where the base type is not a simple `patch`, *i.e.* for the `symmetryPlane` and `empty` patches.

## 5.2.2 Base types

The base and geometric types are described below; the keywords used for specifying these types in OpenFOAM are summarised in [Table 5.2](#).

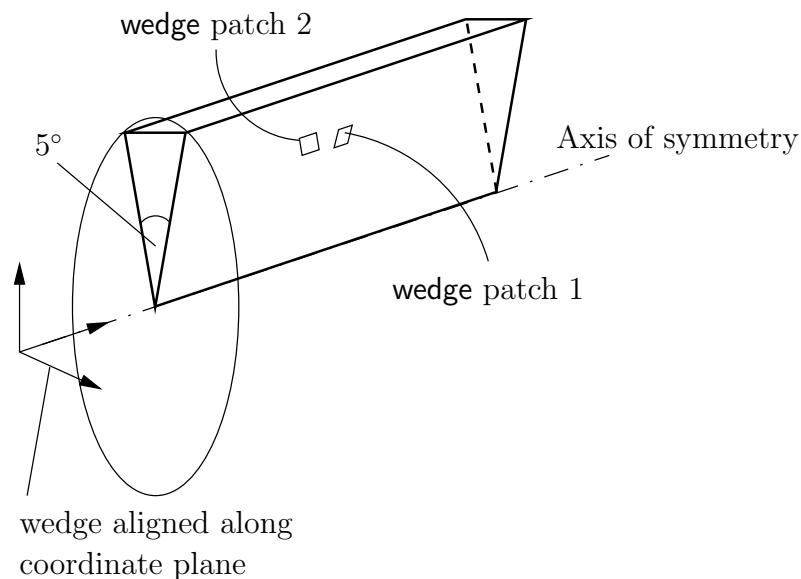

Figure 5.3: Axi-symmetric geometry using the `wedge` patch type.

Selection Key	Description
<code>patch</code>	generic patch
<code>symmetryPlane</code>	plane of symmetry
<code>empty</code>	front and back planes of a 2D geometry
<code>wedge</code>	wedge front and back for an axi-symmetric geometry
<code>cyclic</code>	cyclic plane
<code>wall</code>	wall — used for wall functions in turbulent flows
<code>processor</code>	inter-processor boundary

Table 5.2: Basic patch types.

**patch** The basic patch type for a patch condition that contains no geometric or topological information about the mesh (with the exception of **wall**), *e.g.* an inlet or an outlet.

**wall** There are instances where a patch that coincides with a wall needs to be identifiable as such, particularly where specialist modelling is applied at wall boundaries. A good example is wall turbulence modelling where a wall must be specified with a **wall** patch type, so that the distance from the wall of the cell centres next to the wall are stored as part of the patch.

**symmetryPlane** For a symmetry plane.

**empty** While OpenFOAM always generates geometries in 3 dimensions, it can be instructed to solve in 2 (or 1) dimensions by specifying a special **empty** condition on each patch whose plane is normal to the 3rd (and 2nd) dimension for which no solution is required.

**wedge** For 2 dimensional axi-symmetric cases, *e.g.* a cylinder, the geometry is specified as a wedge of  $5^\circ$  angle and 1 cell thick running along the plane of symmetry, straddling one of the coordinate planes, as shown in [Figure 5.3](#). The axi-symmetric wedge planes must be specified as separate patches of **wedge** type. The details of generating wedge-shaped geometries using **blockMesh** are described in [section 5.3.3](#).

**cyclic** Enables two patches to be treated as if they are physically connected; used for repeated geometries, *e.g.* heat exchanger tube bundles. A single **cyclic** patch splits the faces in its **faceList** into two, and links the two sets of faces as shown in [Figure 5.4](#). Each face-face pair must be of the same area but the faces do not need to be of the same orientation.

**processor** If a code is being run in parallel, on a number of processors, then the mesh must be divided up so that each processor computes on roughly the same number of cells. The boundaries between the different parts of the mesh are called **processor** boundaries.

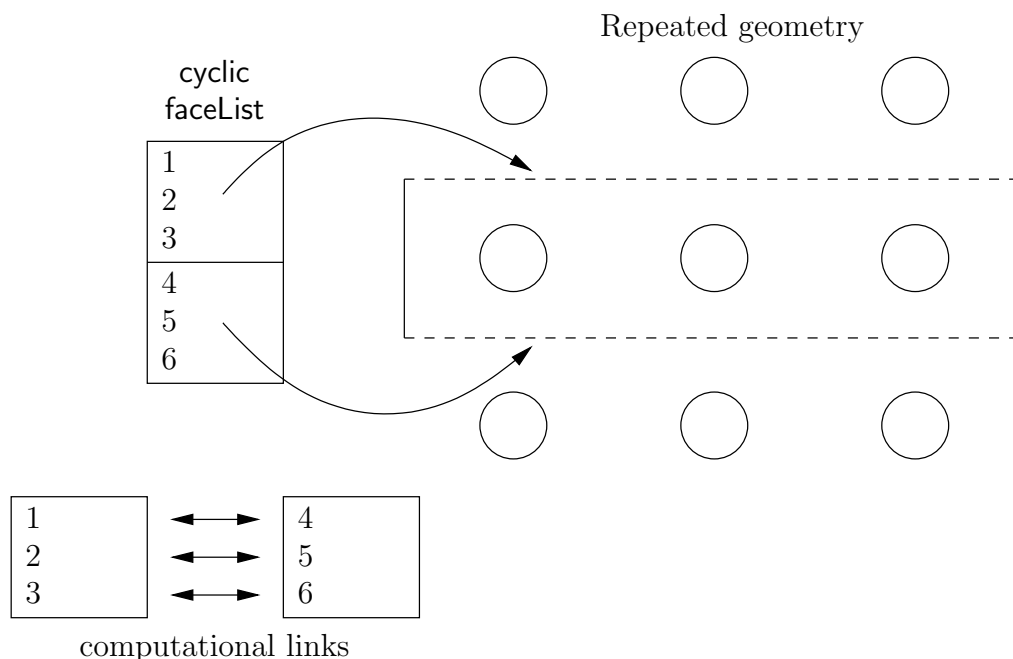

Figure 5.4: Repeated geometry using the cyclic patch type.

### 5.2.3 Primitive types

The primitive types are listed in [Table 5.3](#).

Type	Description of condition for patch field $\phi$	Data to specify
<code>fixedValue</code>	Value of $\phi$ is specified	<code>value</code>
<code>fixedGradient</code>	Normal gradient of $\phi$ is specified	<code>gradient</code>
<code>zeroGradient</code>	Normal gradient of $\phi$ is zero	—
<code>calculated</code>	Boundary field $\phi$ derived from other fields	—
<code>mixed</code>	Mixed <code>fixedValue</code> / <code>fixedGradient</code> condition depending on the value in <code>valueFraction</code>	<code>refValue</code> , <code>refGradient</code> , <code>valueFraction</code> , <code>value</code>
<code>directionMixed</code>	A mixed condition normal to the patch with a <code>fixedGradient</code> condition tangential to the patch	<code>refValue</code> , <code>refGradient</code> , <code>valueFraction</code> , <code>value</code>

Table 5.3: Primitive patch field types.

### 5.2.4 Derived types

There are numerous derived types of boundary conditions in OpenFOAM, too many to list here. Instead a small selection is listed in [Table 5.4](#). If the user wishes to obtain a list of all available model, they should consult the OpenFOAM source code. Derived boundary condition source code can be found at the following locations:

- in `$FOAM_SRC/finiteVolume/fields/fvPatchFields/derived`
- within certain model libraries, that can be located by typing the following command in a terminal window

```
find $FOAM_SRC -name "*derivedFvPatch*"
```

- within certain solvers, that can be located by typing the following command in a terminal window

```
find $FOAM_SOLVERS -name "*fvPatch*"
```

## 5.3 Mesh generation with the blockMesh utility

This section describes the mesh generation utility, `blockMesh`, supplied with OpenFOAM. The `blockMesh` utility creates parametric meshes with grading and curved edges.

The mesh is generated from a dictionary file named `blockMeshDict` located in the `constant/polyMesh` directory of a case. `blockMesh` reads this dictionary, generates the mesh and writes out the mesh data to `points` and `faces`, `cells` and `boundary` files in the same directory.

The principle behind `blockMesh` is to decompose the domain geometry into a set of 1 or more three dimensional, hexahedral blocks. Edges of the blocks can be straight lines,

Types derived from fixedValue		Data to specify
movingWallVelocity	Replaces the normal of the patch <code>value</code> so the flux across the patch is zero	<code>value</code>
pressureInletVelocity	When $p$ is known at inlet, $\mathbf{U}$ is evaluated from the flux, normal to the patch	<code>value</code>
pressureDirectedInletVelocity	When $p$ is known at inlet, $\mathbf{U}$ is calculated from the flux in the <code>inletDirection</code>	<code>value</code> , <code>inletDirection</code>
surfaceNormalFixedValue	Specifies a vector boundary condition, normal to the patch, by its magnitude; +ve for vectors pointing out of the domain	<code>value</code>
totalPressure	Total pressure $p_0 = p + \frac{1}{2}\rho \mathbf{U} ^2$ is fixed; when $\mathbf{U}$ changes, $p$ is adjusted accordingly	<code>p0</code>
turbulentInlet	Calculates a fluctuating variable based on a scale of a mean value	<code>referenceField</code> , <code>fluctuationScale</code>
Types derived from fixedGradient/zeroGradient		
fluxCorrectedVelocity	Calculates normal component of $\mathbf{U}$ at inlet from flux	<code>value</code>
wallBuoyantPressure	Sets <code>fixedGradient</code> pressure based on the atmospheric pressure gradient	—
Types derived from mixed		
inletOutlet	Switches $\mathbf{U}$ and $p$ between <code>fixedValue</code> and <code>zeroGradient</code> depending on direction of $\mathbf{U}$	<code>inletValue</code> , <code>value</code>
outletInlet	Switches $\mathbf{U}$ and $p$ between <code>fixedValue</code> and <code>zeroGradient</code> depending on direction of $\mathbf{U}$	<code>outletValue</code> , <code>value</code>
pressureInletOutletVelocity	Combination of <code>pressureInletVelocity</code> and <code>inletOutlet</code>	<code>value</code>
pressureDirected- InletOutletVelocity	Combination of <code>pressureDirectedInletVelocity</code> and <code>inletOutlet</code>	<code>value</code> , <code>inletDirection</code>
pressureTransmissive	Transmits supersonic pressure waves to surrounding pressure $p_\infty$	<code>pInf</code>
supersonicFreeStream	Transmits oblique shocks to surroundings at $p_\infty$ , $T_\infty$ , $\mathbf{U}_\infty$	<code>pInf</code> , <code>TInf</code> , <code>UInf</code>
Other types		
slip	<code>zeroGradient</code> if $\phi$ is a scalar; if $\phi$ is a vector, normal component is <code>fixedValue zero</code> , tangential components are <code>zeroGradient</code>	—
partialSlip	Mixed <code>zeroGradient</code> / <code>slip</code> condition depending on the <code>valueFraction</code> ; = 1 for <code>slip</code>	<code>valueFraction</code>

Note:  $p$  is pressure,  $\mathbf{U}$  is velocity

Table 5.4: Derived patch field types.

arcs or splines. The mesh is ostensibly specified as a number of cells in each direction of the block, sufficient information for `blockMesh` to generate the mesh data.

Each block of the geometry is defined by 8 vertices, one at each corner of a hexahedron. The vertices are written in a list so that each vertex can be accessed using its label, remembering that OpenFOAM always uses the C++ convention that the first element of the list has label '0'. An example block is shown in [Figure 5.5](#) with each vertex numbered according to the list. The edge connecting vertices 1 and 5 is curved to remind the reader that curved edges can be specified in `blockMesh`.

It is possible to generate blocks with less than 8 vertices by collapsing one or more pairs of vertices on top of each other, as described in [section 5.3.3](#).

Each block has a local coordinate system  $(x_1, x_2, x_3)$  that must be right-handed. A right-handed set of axes is defined such that to an observer looking down the  $Oz$  axis, with  $O$  nearest them, the arc from a point on the  $Ox$  axis to a point on the  $Oy$  axis is in a clockwise sense.

The local coordinate system is defined by the order in which the vertices are presented in the block definition according to:

- the axis origin is the first entry in the block definition, vertex 0 in our example;
- the  $x_1$  direction is described by moving from vertex 0 to vertex 1;

Keyword	Description	Example/selection
<code>convertToMeters</code>	Scaling factor for the vertex coordinates	0.001 scales to mm
<code>vertices</code>	List of vertex coordinates	(0 0 0)
<code>edges</code>	Used to describe arc or spline edges	arc 1 4 (0.939 0.342 -0.5)
<code>block</code>	Ordered list of vertex labels and mesh size	hex (0 1 2 3 4 5 6 7) (10 10 1) simpleGrading (1.0 1.0 1.0)
<code>patches</code>	List of patches	symmetryPlane base ( (0 1 2 3) )
<code>mergePatchPairs</code>	List of patches to be merged	see <a href="#">section 5.3.2</a>

Table 5.5: Keywords used in *blockMeshDict*.

```
convertToMeters    0.001;
```

means that all coordinates are multiplied by 0.001, *i.e.* the values quoted in the *blockMeshDict* file are in mm.

### 5.3.1.1 The vertices

The vertices of the blocks of the mesh are given next as a standard list named `vertices`, *e.g.* for our example block in [Figure 5.5](#), the vertices are:

```
vertices
(
    ( 0    0    0 )    // vertex number 0
    ( 1    0    0.1)  // vertex number 1
    ( 1.1  1    0.1)  // vertex number 2
    ( 0    1    0.1)  // vertex number 3
    (-0.1 -0.1  1 )  // vertex number 4
    ( 1.3  0    1.2)  // vertex number 5
    ( 1.4  1.1  1.3)  // vertex number 6
    ( 0    1    1.1)  // vertex number 7
);
```

### 5.3.1.2 The edges

Each edge joining 2 vertex points is assumed to be straight by default. However any edge may be specified to be curved by entries in a list named `edges`. The list is optional; if the geometry contains no curved edges, it may be omitted.

Each entry for a curved edge begins with a keyword specifying the type of curve from those listed in [Table 5.6](#).

The keyword is then followed by the labels of the 2 vertices that the edge connects. Following that, interpolation points must be specified through which the edge passes. For a `arc`, a single interpolation point is required, which the circular arc will intersect. For `simpleSpline`, `polyLine` and `polySpline`, a list of interpolation points is required. The `line` edge is directly equivalent to the option executed by default, and requires no

Keyword selection	Description	Additional entries
<code>arc</code>	Circular arc	Single interpolation point
<code>simpleSpline</code>	Spline curve	List of interpolation points
<code>polyLine</code>	Set of lines	List of interpolation points
<code>polySpline</code>	Set of splines	List of interpolation points
<code>line</code>	Straight line	—

Table 5.6: Edge types available in the *blockMeshDict* dictionary.

interpolation points. Note that there is no need to use the `line` edge but it is included for completeness. For our example block in [Figure 5.5](#) we specify an `arc` edge connecting vertices 1 and 5 as follows through the interpolation point (1.1, 0.0, 0.5):

```
edges
(
    arc 1 5 (1.1 0.0 0.5)
);
```

### 5.3.1.3 The blocks

The block definitions are contained in a list named `blocks`. Each block definition is a compound entry consisting of a list of vertex labels whose order is described in [section 5.3](#), a vector giving the number of cells required in each direction, the type and list of cell expansion ratio in each direction.

Then the blocks are defined as follows:

```
blocks
(
    hex (0 1 2 3 4 5 6 7) // vertex numbers
    (10 10 10) // numbers of cells in each direction
    simpleGrading (1 2 3) // cell expansion ratios
);
```

The definition of each block is as follows:

**Vertex numbering** The first entry is the shape identifier of the block, as defined in the *.OpenFOAM-1.6/cellModels* file. The shape is always `hex` since the blocks are always hexahedra. There follows a list of vertex numbers, ordered in the manner described on page [U-134](#).

**Number of cells** The second entry gives the number of cells in each of the  $x_1$   $x_2$  and  $x_3$  directions for that block.

**Cell expansion ratios** The third entry gives the cell expansion ratios for each direction in the block. The expansion ratio enables the mesh to be graded, or refined, in specified directions. The ratio is that of the width of the end cell  $\delta_e$  along one edge of a block to the width of the start cell  $\delta_s$  along that edge, as shown in [Figure 5.6](#). Each of the following keywords specify one of two types of grading specification available in `blockMesh`.

`simpleGrading` The simple description specifies uniform expansions in the local  $x_1$ ,  $x_2$  and  $x_3$  directions respectively with only 3 expansion ratios, *e.g.*



```
simpleGrading (1 2 3)
```

**edgeGrading** The full cell expansion description gives a ratio for each edge of the block, numbered according to the scheme shown in [Figure 5.5](#) with the arrows representing the direction ‘from first cell... to last cell’ *e.g.* something like

```
edgeGrading (1 1 1 1 2 2 2 2 3 3 3 3)
```

This means the ratio of cell widths along edges 0-3 is 1, along edges 4-7 is 2 and along 8-11 is 3 and is directly equivalent to the **simpleGrading** example given above.

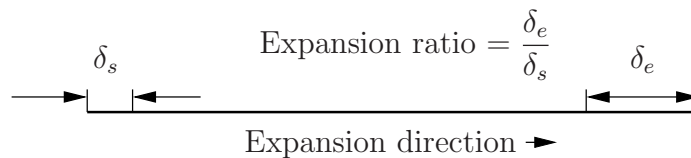

Figure 5.6: Mesh grading along a block edge

#### 5.3.1.4 The patches

The patches of the mesh are given in a list named **patches**. Each patch in the list is a compound entry containing:

- the patch type, either a generic **patch** on which some boundary conditions are applied or a particular geometric condition, as listed in [Table 5.2](#) and described in [section 5.2.2](#);
- a list of block faces that make up the patch and whose name is the choice of the user, although we recommend something that conveniently identifies the patch, *e.g.* `quoteTextinlet`; the name is used as an identifier for for for setting boundary conditions in the field data files.

**blockMesh** collects faces from any boundary patch that is omitted from the **patches** list and assigns them to a default patch named **defaultFaces** of type **empty**. This means that for a 2 dimensional geometry, the user has the option to omit block faces lying in the 2D plane, knowing that they will be collected into an **empty** patch as required.

Returning to the example block in [Figure 5.5](#), if it has an inlet on the left face, an output on the right face and the four other faces are walls then the patches could be defined as follows:

```
patches // keyword
(
  patch // patch type for patch 0
  inlet // patch name
  (
    (0 4 7 3) // block face in this patch
  ) // end of 0th patch definition

  patch // patch type for patch 1
  outlet // arbitrary patch name
  (
    (1 2 6 5)
```

```

    )

    wall
    walls
    (
        (0 1 5 4)
        (0 3 2 1)
        (3 7 6 2)
        (4 5 6 7)
    )
);

```

Each block face is defined by a list of 4 vertex numbers. The order in which the vertices are given **must** be such that, looking from inside the block and starting with any vertex, the face must be traversed in a clockwise direction to define the other vertices.

### 5.3.2 Multiple blocks

A mesh can be created using more than 1 block. In such circumstances, the mesh is created as has been described in the preceding text; the only additional issue is the connection between blocks, in which there are two distinct possibilities:

**face matching** the set of faces that comprise a patch from one block are exactly collocated with a set of faces patch that comprise a patch from another block;

**face merging** a group of faces from a patch from one block are connected to another group of faces from a patch from another block, to create a new set of internal faces connecting the two blocks.

To connect two blocks with **face matching**, the two patches that form the connection should simply be ignored from the `patches` list. `blockMesh` then identifies that the faces do not form an external boundary and combines each collocated pair into a single internal faces that connects cells from the two blocks.

The alternative, **face merging**, requires that the block patches to be merged are first defined in the `patches` list. Each pair of patches whose faces are to be merged must then be included in an optional list named `mergePatchPairs`. The format of `mergePatchPairs` is:

```

mergePatchPairs
(
    ( <masterPatch> <slavePatch> ) // merge patch pair 0
    ( <masterPatch> <slavePatch> ) // merge patch pair 1
    ...
)

```

The pairs of patches are interpreted such that the first patch becomes the *master* and the second becomes the *slave*. The rules for merging are as follows:

- the faces of the master patch remain as originally defined, with all vertices in their original location;
- the faces of the slave patch are projected onto the master patch where there is some separation between slave and master patch;

- the location of any vertex of a slave face might be adjusted by `blockMesh` to eliminate any face edge that is shorter than a minimum tolerance;
- if patches overlap as shown in [Figure 5.7](#), each face that does not merge remains as an external face of the original patch, on which boundary conditions must then be applied;
- if all the faces of a patch are merged, then the patch itself will contain no faces and is removed.

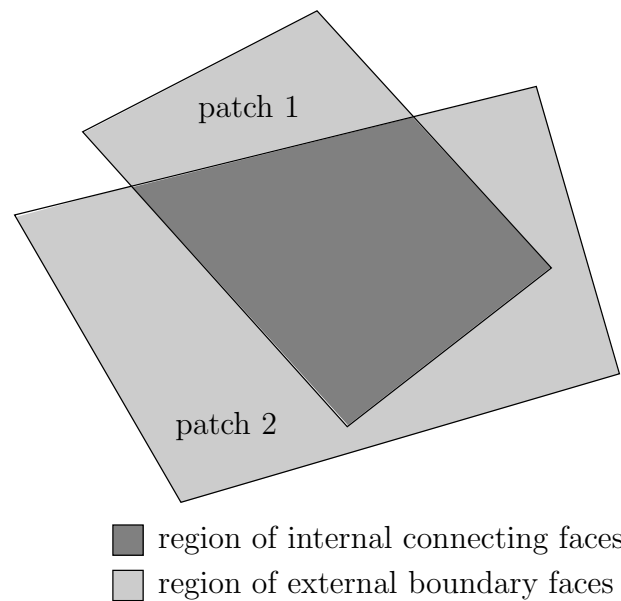

Figure 5.7: Merging overlapping patches

The consequence is that the original geometry of the slave patch will not necessarily be completely preserved during merging. Therefore in a case, say, where a cylindrical block is being connected to a larger block, it would be wise to assign the master patch to the cylinder, so that its cylindrical shape is correctly preserved. There are some additional recommendations to ensure successful merge procedures:

- in 2 dimensional geometries, the size of the cells in the third dimension, *i.e.* out of the 2D plane, should be similar to the width/height of cells in the 2D plane;
- it is inadvisable to merge a patch twice, *i.e.* include it twice in `mergePatchPairs`;
- where a patch to be merged shares a common edge with another patch to be merged, both should be declared as a master patch.

### 5.3.3 Creating blocks with fewer than 8 vertices

It is possible to collapse one or more pair(s) of vertices onto each other in order to create a block with fewer than 8 vertices. The most common example of collapsing vertices is when creating a 6-sided wedge shaped block for 2-dimensional axi-symmetric cases that use the `wedge` patch type described in [section 5.2.2](#). The process is best illustrated by using a simplified version of our example block shown in [Figure 5.8](#). Let us say we wished to create a wedge shaped block by collapsing vertex 7 onto 4 and 6 onto 5. This is simply done by exchanging the vertex number 7 by 4 and 6 by 5 respectively so that the block numbering would become:

```
hex (0 1 2 3 4 5 5 4)
```

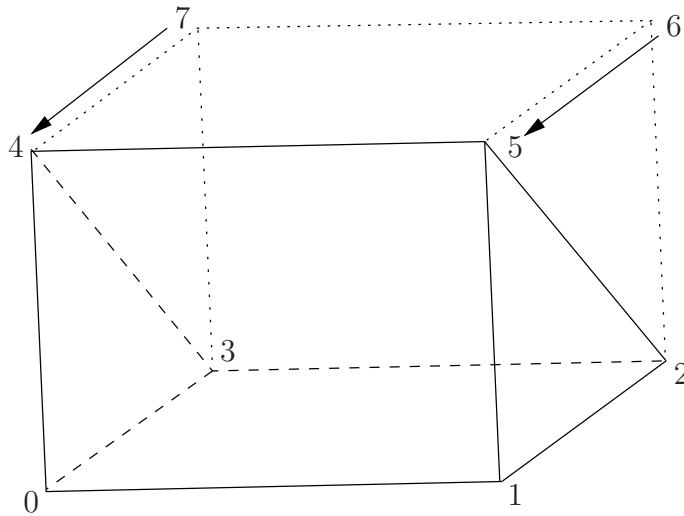

Figure 5.8: Creating a wedge shaped block with 6 vertices

The same applies to the patches with the main consideration that the block face containing the collapsed vertices, previously (4 5 6 7) now becomes (4 5 5 4). This is a block face of zero area which creates a patch with no faces in the `polyMesh`, as the user can see in a *boundary* file for such a case. The patch should be specified as `empty` in the *blockMeshDict* and the boundary condition for any fields should consequently be empty also.

### 5.3.4 Running blockMesh

As described in [section 3.3](#), the following can be executed at the command line to run `blockMesh` for a case in the `<case>` directory:

```
blockMesh -case <case>
```

The *blockMeshDict* file must exist in subdirectory *constant/polyMesh*.

## 5.4 Mesh generation with the snappyHexMesh utility

This section describes the mesh generation utility, `snappyHexMesh`, supplied with OpenFOAM. The `snappyHexMesh` utility generates 3-dimensional meshes containing hexahedra (hex) and split-hexahedra (split-hex) automatically from triangulated surface geometries in Stereolithography (STL) format. The mesh approximately conforms to the surface by iteratively refining a starting mesh and morphing the resulting split-hex mesh to the surface. An optional phase will shrink back the resulting mesh and insert cell layers. The specification of mesh refinement level is very flexible and the surface handling is robust with a pre-specified final mesh quality. It runs in parallel with a load balancing step every iteration.

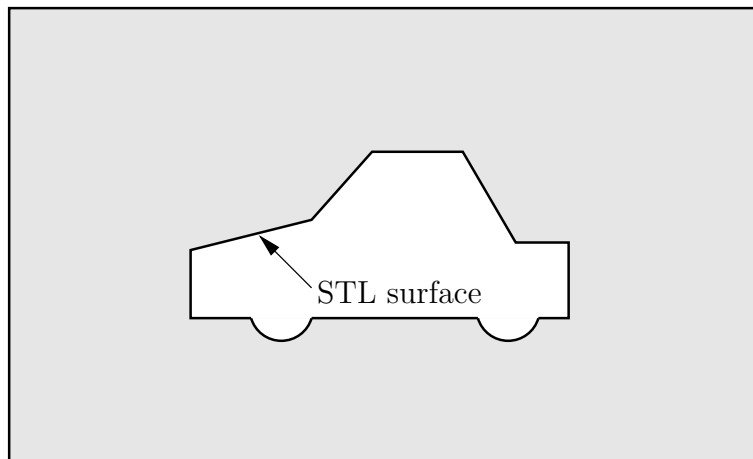

Figure 5.9: Schematic 2D meshing problem for `snappyHexMesh`

### 5.4.1 The mesh generation process of `snappyHexMesh`

The process of generating a mesh using `snappyHexMesh` will be described using the schematic in [Figure 5.9](#). The objective is to mesh a rectangular shaped region (shaded grey in the figure) surrounding an object described by an STL surface, *e.g.* typical for an external aerodynamics simulation. Note that the schematic is 2-dimensional to make it easier to understand, even though the `snappyHexMesh` is a 3D meshing tool.

In order to run `snappyHexMesh`, the user requires the following:

- surface data files in STL format, either binary or ASCII, located in a `triSurface` sub-directory of the case directory;
- a background hex mesh which defines the extent of the computational domain and a base level mesh density; typically generated using `blockMesh`, discussed in [section 5.4.2](#).
- a `snappyHexMeshDict` dictionary, with appropriate entries, located in the `system` sub-directory of the case.

The `snappyHexMeshDict` dictionary includes: switches at the top level that control the various stages of the meshing process; and, individual sub-directories for each process. The entries are listed in [Table 5.7](#).

All the geometry used by `snappyHexMesh` is specified in a `geometry` sub-dictionary in the `snappyHexMeshDict` dictionary. The geometry can be specified through an STL surface or bounding geometry entities in OpenFOAM. An example is given below:

```

geometry
{
  sphere.stl // STL filename
  {
    type triSurfaceMesh;
    regions
    {
      secondSolid // Named region in the STL file
      {
        name mySecondPatch; // User-defined patch name
      } // otherwise given sphere.stl_secondSolid
    }
  }

  box1x1x1 // User defined region name
  {
    type searchableBox; // region defined by bounding box
    min (1.5 1 -0.5);
  }
}

```

Keyword	Description	Example
castellatedMesh	Create the castellated mesh?	true
snap	Do the surface snapping stage?	true
doLayers	Add surface layers?	true
mergeTolerance	Merge tolerance as fraction of bounding box of initial mesh	1e-06
debug	Controls writing of intermediate meshes and screen printing	
	— Write final mesh only	0
	— Write intermediate meshes	1
	— Write volScalarField with cellLevel for post-processing	2
	— Write current intersections as .obj files	4
geometry	Sub-dictionary of all surface geometry used	
castellatedMeshControls	Sub-dictionary of controls for castellated mesh	
snapControls	Sub-dictionary of controls for surface snapping	
addLayersControls	Sub-dictionary of controls for layer addition	
meshQualityControls	Sub-dictionary of controls for mesh quality	

Table 5.7: Keywords at the top level of *snappyHexMeshDict*.

```

    max    (3.5 2 0.5);
}

sphere2 // User defined region name
{
    type    searchableSphere; // region defined by bounding sphere
    centre (1.5 1.5 1.5);
    radius 1.03;
}
};

```

### 5.4.2 Creating the background hex mesh

Before *snappyHexMesh* is executed the user must create a background mesh of hexahedral cells that fills the entire region within by the external boundary as shown in [Figure 5.10](#). This can be done simply using *blockMesh*. The following criteria must be observed when

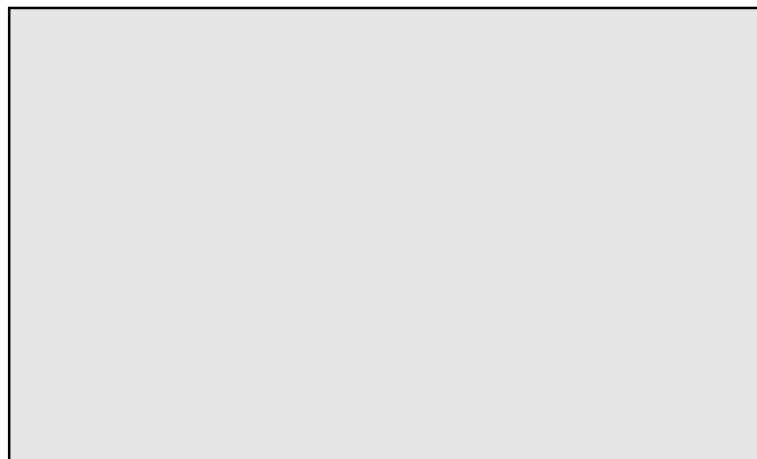

- the mesh must consist purely of hexes;
- the cell aspect ratio should be approximately 1, at least near surfaces at which the subsequent snapping procedure is applied, otherwise the convergence of the snapping procedure is slow, possibly to the point of failure;
- there must be at least one intersection of a cell edge with the STL surface, *i.e.* a mesh of one cell will not work.

### 5.4.3 Cell splitting at feature edges and surfaces

Cell splitting is performed according to the specification supplied by the user in the `castellatedMeshControls` sub-dictionary in the `snappyHexMeshDict`. The entries for `castellatedMeshControls` are presented in [Table 5.8](#).

Keyword	Description	Example
<code>locationInMesh</code>	Location vector inside the region to be meshed <i>N.B.</i> vector must not coincide with a cell face either before or during refinement	(5 0 0)
<code>maxLocalCells</code>	Max number of cells per processor during refinement	1e+06
<code>maxGlobalCells</code>	Overall cell limit during refinement ( <i>i.e.</i> before removal)	2e+06
<code>minRefinementCells</code>	If $\geq$ number of cells to be refined, surface refinement stops	0
<code>nCellsBetweenLevels</code>	Number of buffer layers of cells between different levels of refinement	1
<code>resolveFeatureAngle</code>	Applies maximum level of refinement to cells that can see intersections whose angle exceeds this	30
<code>features</code>	List of features for refinement	
<code>refinementSurfaces</code>	Dictionary of surfaces for refinement	
<code>refinementRegions</code>	Dictionary of regions for refinement	

Table 5.8: Keywords in the `castellatedMeshControls` sub-dictionary of `snappyHexMeshDict`.

The splitting process begins with cells being selected according to specified edge features first within the domain as illustrated in [Figure 5.11](#). The `features` list in the `castellatedMeshControls` sub-dictionary permits dictionary entries containing a name of an `edgeMesh` file and the `level` of refinement, *e.g.*:

```
features
(
  {
    file "someLine.eMesh"; // file containing edge mesh
    level 2;                // level of refinement
  }
);
```

Following feature refinement, cells are selected for splitting in the locality of specified surfaces as illustrated in [Figure 5.12](#). The `refinementSurfaces` dictionary in `castellatedMeshControls` requires dictionary entries for each STL surface and a default `level` specification of the minimum and maximum refinement in the form (`<min>` `<max>`).

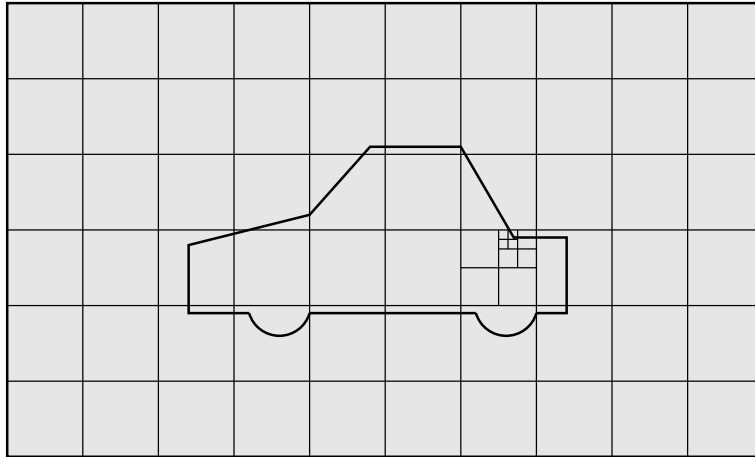

Figure 5.11: Cell splitting by feature edge in `snappyHexMesh` meshing process



Figure 5.12: Cell splitting by surface in `snappyHexMesh` meshing process

The minimum level is applied generally across the surface; the maximum level is applied to cells that can see intersections that form an angle in excess of that specified by `resolveFeatureAngle`.

The refinement can optionally be overridden on one or more specific region of an STL surface. The region entries are collected in a `regions` sub-dictionary. The keyword for each region entry is the name of the region itself and the refinement level is contained within a further sub-dictionary. An example is given below:

```
refinementSurfaces
{
  sphere.stl
  {
    level (2 2); // default (min max) refinement for whole surface
    regions
    {
      secondSolid
      {
        level (3 3); // optional refinement for secondSolid region
      }
    }
  }
}
```

#### 5.4.4 Cell removal

Once the feature and surface splitting is complete a process of cell removal begins. Cell removal requires one or more regions enclosed entirely by a bounding surface within the



domain. The region in which cells are retained are simply identified by a location vector within that region, specified by the `locationInMesh` keyword in `castellatedMeshControls`. Cells are retained if, approximately speaking, 50% or more of their volume lies within the region. The remaining cells are removed accordingly as illustrated in [Figure 5.13](#).

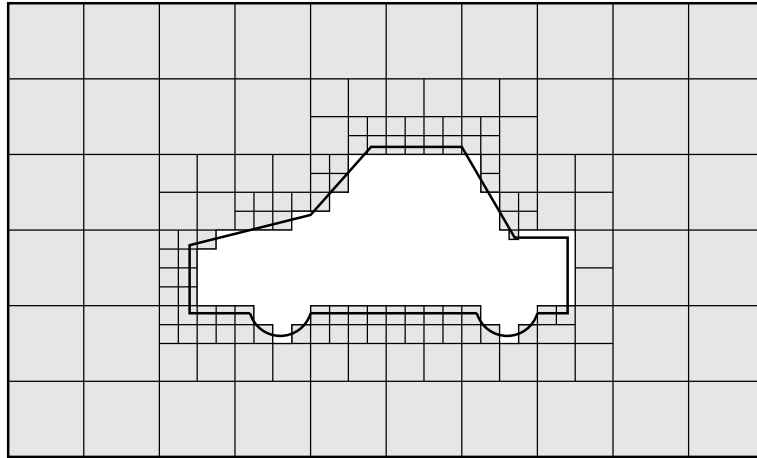

Figure 5.13: Cell removal in snappyHexMesh meshing process

#### 5.4.5 Cell splitting in specified regions

Those cells that lie within one or more specified volume regions can be further split as illustrated in [Figure 5.14](#) by a rectangular region shown by dark shading. The `refinement-`

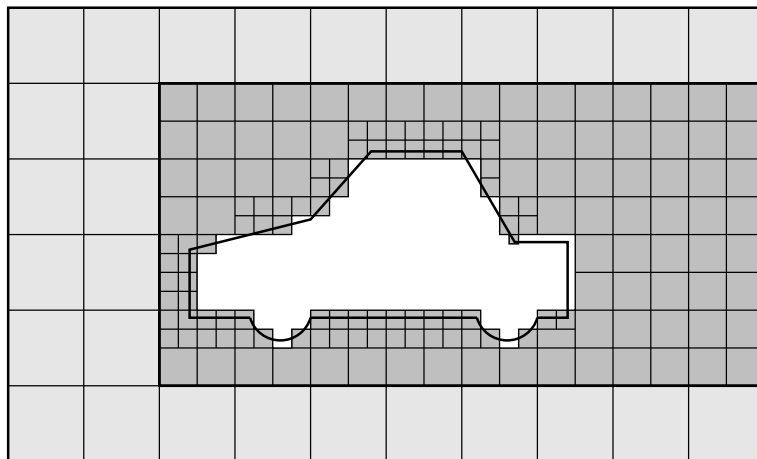

Figure 5.14: Cell splitting by region in snappyHexMesh meshing process

`Regions` sub-dictionary in `castellatedMeshControls` contains entries for refinement of the volume regions specified in the `geometry` sub-dictionary. A refinement mode is applied to each region which can be:

- `inside` refines inside the volume region;
- `outside` refines outside the volume region
- `distance` refines according to distance to the surface; and can accommodate different levels at multiple distances with the `levels` keyword.

For the `refinementRegions`, the refinement level is specified by the `levels` list of entries with the format(`<distance> <level>`). In the case of `inside` and `outside` refinement, the `<distance>` is not required so is ignored (but it must be specified). Examples are shown below:

```
refinementRegions
{
  box1x1x1
  {
    mode inside;
    levels ((1.0 4));           // refinement level 4 (1.0 entry ignored)
  }

  sphere.stl
  {
    mode distance;           // refinement level 5 within 1.0 m
    levels ((1.0 5) (2.0 3)); // refinement level 3 within 2.0 m
                              // levels must be ordered nearest first
  }
}
```

### 5.4.6 Snapping to surfaces

The next stage of the meshing process involves moving cell vertex points onto surface geometry to remove the jagged castellated surface from the mesh. The process is:

1. displace the vertices in the castellated boundary onto the STL surface;
2. solve for relaxation of the internal mesh with the latest displaced boundary vertices;
3. find the vertices that cause mesh quality parameters to be violated;
4. reduce the displacement of those vertices from their initial value (at 1) and repeat from 2 until mesh quality is satisfied.

The method uses the settings in the `snapControls` sub-dictionary in `snappyHexMeshDict`, listed in [Table 5.9](#). An example is illustrated in the schematic in [Figure 5.15](#) (albeit with

Keyword	Description	Example
<code>nSmoothPatch</code>	Number of patch smoothing iterations before finding correspondence to surface	3
<code>tolerance</code>	Ratio of distance for points to be attracted by surface feature point or edge, to local maximum edge length	4.0
<code>nSolveIter</code>	Number of mesh displacement relaxation iterations	30
<code>nRelaxIter</code>	Maximum number of snapping relaxation iterations	5

Table 5.9: Keywords in the `snapControls` dictionary of `snappyHexMeshDict`.

mesh motion that looks slightly unrealistic).

### 5.4.7 Mesh layers

The mesh output from the snapping stage may be suitable for the purpose, although it can produce some irregular cells along boundary surfaces. There is an optional stage of the meshing process which introduces additional layers of hexahedral cells aligned to the boundary surface as illustrated by the dark shaded cells in [Figure 5.16](#).

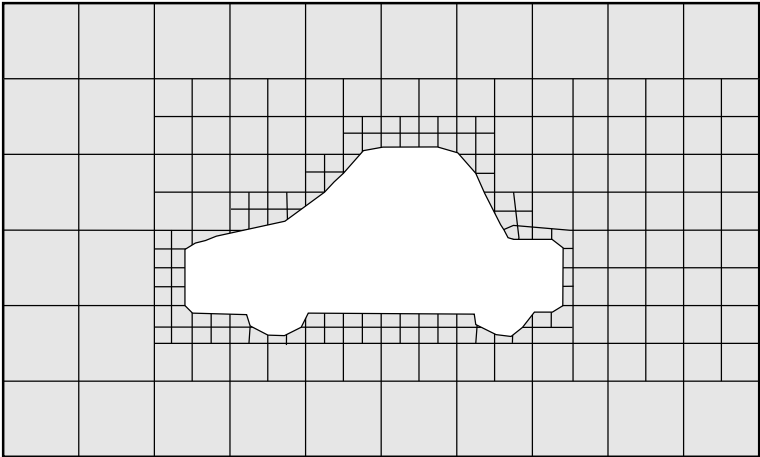
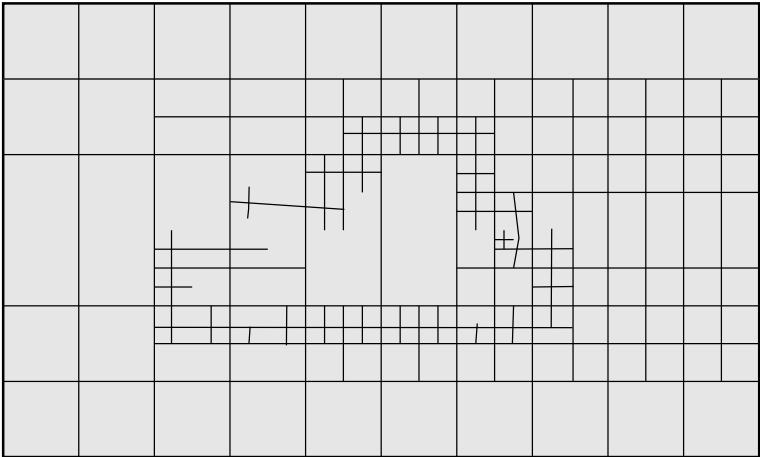

Figure 5.15: Surface snapping in snappyHexMesh meshing process



Keyword	Description	Example
<code>layers</code>	Dictionary of layers	
<code>relativeSizes</code>	Are layer thicknesses relative to undistorted cell size outside layer or absolute?	<code>true/false</code>
<code>expansionRatio</code>	Expansion factor for layer mesh	1.0
<code>finalLayerRatio</code>	Thickness of layer furthest from the wall, either relative or absolute according to the <code>relativeSizes</code> entry	0.3
<code>minThickness</code>	Minimum thickness of cell layer, either relative or absolute (as above)	0.25
<code>nGrow</code>	Number of layers of connected faces that are not grown if points get not extruded; helps convergence of layer addition close to features	1
<code>featureAngle</code>	Angle above which surface is not extruded	60
<code>nRelaxIter</code>	Maximum number of snapping relaxation iterations	5
<code>nSmoothSurfaceNormals</code>	Number of smoothing iterations of surface normals	1
<code>nSmoothNormals</code>	Number of smoothing iterations of interior mesh movement direction	3
<code>nSmoothThickness</code>	Smooth layer thickness over surface patches	10
<code>maxFaceThicknessRatio</code>	Stop layer growth on highly warped cells	0.5
<code>maxThicknessToMedialRatio</code>	Reduce layer growth where ratio thickness to medial distance is large	0.3
<code>minMedianAxisAngle</code>	Angle used to pick up medial axis points	130
<code>nBufferCellsNoExtrude</code>	Create buffer region for new layer terminations	0
<code>nLayerIter</code>	Overall max number of layer addition iterations	50
<code>nRelaxedIter</code>	Max number of iterations after which the controls in the <i>relaxed</i> sub dictionary of <code>meshQuality</code> are used	20

Table 5.10: Keywords in the *addLayersControls* sub-dictionary of *snappyHexMeshDict*.

```

{
    nSurfaceLayers 1;
}
maxY
{
    nSurfaceLayers 1;
}
}

```

### 5.4.8 Mesh quality controls

The mesh quality is controlled by the entries in the *meshQualityControls* sub-dictionary in *snappyHexMeshDict*; entries are listed in [Table 5.11](#).

## 5.5 Mesh conversion

The user can generate meshes using other packages and convert them into the format that OpenFOAM uses. There are numerous mesh conversion utilities listed in [Table 3.6](#).

Keyword	Description	Example
<code>maxNonOrtho</code>	Maximum non-orthogonality allowed; 180 disables	65
<code>maxBoundarySkewness</code>	Max boundary face skewness allowed; <0 disables	20
<code>maxInternalSkewness</code>	Max internal face skewness allowed; <0 disables	4
<code>maxConcave</code>	Max concaveness allowed; 180 disables	80
<code>minFlatness</code>	Ratio of minimum projected area to actual area; -1 disables	0.5
<code>minVol</code>	Minimum pyramid volume; large negative number, <i>e.g.</i> <code>-1e30</code> disables	<code>1e-13</code>
<code>minArea</code>	Minimum face area; <0 disables	-1
<code>minTwist</code>	Minimum face twist; <-1 disables	0.05
<code>minDeterminant</code>	Minimum normalised cell determinant; 1 = hex; $\leq 0$ illegal cell	0.001
<code>minFaceWeight</code>	0→0.5	0.05
<code>minVolRatio</code>	0→1.0	0.01
<code>minTriangleTwist</code>	>0 for Fluent compatability	-1
<code>nSmoothScale</code>	Number of error distribution iterations	4
<code>errorReduction</code>	Amount to scale back displacement at error points	0.75
<code>relaxed</code>	Sub-dictionary that can include modified values for the above keyword entries to be used when <code>nRelaxedIter</code> is exceeded in the layer addition process	<code>relaxed</code> { ... }

Table 5.11: Keywords in the *meshQualityControls* sub-dictionary of *snappyHexMeshDict*.

Some of the more popular mesh converters are listed below and their use is presented in this section.

`fluentMeshToFoam` reads a `Fluent.msh` mesh file, working for both 2-D and 3-D cases;

`starToFoam` reads STAR-CD/PROSTAR mesh files.

`gambitToFoam` reads a GAMBIT `.neu` neutral file;

`ideasToFoam` reads an I-DEAS mesh written in `ANSYS.ans` format;

`cfx4ToFoam` reads a CFX mesh written in `.geo` format;

### 5.5.1 `fluentMeshToFoam`

Fluent writes mesh data to a single file with a `.msh` extension. The file must be written in ASCII format, which is not the default option in `Fluent`. It is possible to convert single-stream `Fluent` meshes, including the 2 dimensional geometries. In `OpenFOAM`, 2 dimensional geometries are currently treated by defining a mesh in 3 dimensions, where the front and back plane are defined as the `empty` boundary patch type. When reading a 2 dimensional `Fluent` mesh, the converter automatically extrudes the mesh in the third direction and adds the empty patch, naming it `frontAndBackPlanes`.

The following features should also be observed.

- The OpenFOAM converter will attempt to capture the **Fluent** boundary condition

### 5.5.2.1 General advice on conversion

We strongly recommend that the user run the STAR-CD mesh checking tools before attempting a `starToFoam` conversion and, after conversion, the `checkMesh` utility should be run on the newly converted mesh. Alternatively, `starToFoam` may itself issue warnings containing PROSTAR commands that will enable the user to take a closer look at cells with problems. Problematic cells and matches should be checked and fixed before attempting to use the mesh with OpenFOAM. Remember that an invalid mesh will not run with OpenFOAM, but it may run in another environment that does not impose the validity criteria.

Some problems of tolerance matching can be overcome by the use of a matching tolerance in the converter. However, there is a limit to its effectiveness and an apparent need to increase the matching tolerance from its default level indicates that the original mesh suffers from inaccuracies.

### 5.5.2.2 Eliminating extraneous data

When mesh generation is completed, remove any extraneous vertices and compress the cells boundary and vertex numbering, assuming that fluid cells have been created and all other cells are discarded. This is done with the following PROSTAR commands:

```
CSET NEWS FLUID
CSET INVE
```

The CSET should be empty. If this is not the case, examine the cells in CSET and adjust the model. If the cells are genuinely not desired, they can be removed using the PROSTAR command:

```
CDEL CSET
```

Similarly, vertices will need to be discarded as well:

```
CSET NEWS FLUID
VSET NEWS CSET
VSET INVE
```

Before discarding these unwanted vertices, the unwanted boundary faces have to be collected before purging:

```
CSET NEWS FLUID
VSET NEWS CSET
BSET NEWS VSET ALL
BSET INVE
```

If the BSET is not empty, the unwanted boundary faces can be deleted using:

```
BDEL BSET
```

At this time, the model should contain only the fluid cells and the supporting vertices, as well as the defined boundary faces. All boundary faces should be fully supported by the vertices of the cells, if this is not the case, carry on cleaning the geometry until everything is clean.

### 5.5.2.3 Removing default boundary conditions

By default, STAR-CD assigns wall boundaries to any boundary faces not explicitly associated with a boundary region. The remaining boundary faces are collected into a **default** boundary region, with the assigned boundary type 0. OpenFOAM deliberately does not have a concept of a **default** boundary condition for undefined boundary faces since it invites human error, *e.g.* there is no means of checking that we meant to give all the unassociated faces the default condition.

Therefore **all** boundaries for each OpenFOAM mesh must be specified for a mesh to be successfully converted. The **default** boundary needs to be transformed into a real one using the procedure described below:

1. Plot the geometry with **Wire Surface** option.
2. Define an extra boundary region with the same parameters as the **default** region 0 and add all visible faces into the new region, say 10, by selecting a zone option in the boundary tool and drawing a polygon around the entire screen draw of the model. This can be done by issuing the following commands in **PROSTAR**:

```
RDEF 10 WALL
BZON 10 ALL
```

3. We shall remove all previously defined boundary types from the set. Go through the boundary regions:

```
BSET NEWS REGI 1
BSET NEWS REGI 2
... 3, 4, ...
```

Collect the vertices associated with the boundary set and then the boundary faces associated with the vertices (there will be twice as many of them as in the original set).

```
BSET NEWS REGI 1
VSET NEWS BSET
BSET NEWS VSET ALL
BSET DELE REGI 1
REPL
```

This should give the faces of boundary Region 10 which have been defined on top of boundary Region 1. Delete them with **BDEL BSET**. Repeat these for all regions.

### 5.5.2.4 Renumbering the model

Renumber and check the model using the commands:

```
CSET NEW FLUID
CCOM CSET

VSET NEWS CSET
VSET INVE (Should be empty!)
VSET INVE
VCOM VSET
```





### 5.5.2.6 Problems with the `.vrt` file

The `.vrt` file is written in columns of data of specified width, rather than free format. A typical line of data might be as follows, giving a vertex number followed by the coordinates:

```
19422      -0.105988957      -0.413711881E-02  0.000000000E+00
```

If the ordinates are written in scientific notation and are negative, there may be no space between values, *e.g.*:

```
19423      -0.953953117E-01-0.338810333E-02  0.000000000E+00
```

The `starToFoam` converter reads the data using spaces to delimit the ordinate values and will therefore object when reading the previous example. Therefore, OpenFOAM includes a simple script, `foamCorrectVrt` to insert a space between values where necessary, *i.e.* it would convert the previous example to:

```
19423      -0.953953117E-01 -0.338810333E-02  0.000000000E+00
```

The `foamCorrectVrt` script should therefore be executed if necessary before running the `starToFoam` converter, by typing:

```
foamCorrectVrt <file>.vrt
```

### 5.5.2.7 Converting the mesh to OpenFOAM format

The translator utility `starToFoam` can now be run to create the boundaries, cells and points files necessary for a OpenFOAM run:

```
starToFoam <meshFilePrefix>
```

where `<meshFilePrefix>` is the name of the the prefix of the mesh files, including the full or relative path. After the utility has finished running, OpenFOAM boundary types should be specified by editing the `boundary` file by hand.

### 5.5.3 `gambitToFoam`

GAMBIT writes mesh data to a single file with a `.neu` extension. The procedure of converting a GAMBIT `.neu` file is first to create a new OpenFOAM case, then at a command prompt, the user should execute:

```
gambitToFoam <meshFile>
```

where `<meshFile>` is the name of the `.neu` file, including the full or relative path.

The GAMBIT file format does not provide information about type of the boundary patch, *e.g.* wall, symmetry plane, cyclic. Therefore all the patches have been created as type patch. Please reset after mesh conversion as necessary.

### 5.5.4 ideasToFoam

OpenFOAM can convert a mesh generated by I-DEAS but written out in ANSYS format as a *.ans* file. The procedure of converting the *.ans* file is first to create a new OpenFOAM case, then at a command prompt, the user should execute:

```
ideasToFoam <meshFile>
```

where *<meshFile>* is the name of the *.ans* file, including the full or relative path.

### 5.5.5 cfx4ToFoam

CFX writes mesh data to a single file with a *.geo* extension. The mesh format in CFX is block-structured, *i.e.* the mesh is specified as a set of blocks with glueing information and the vertex locations. OpenFOAM will convert the mesh and capture the CFX boundary condition as best as possible. The 3 dimensional ‘patch’ definition in CFX, containing information about the porous, solid regions *etc.* is ignored with all regions being converted into a single OpenFOAM mesh. CFX supports the concept of a ‘default’ patch, where each external face without a defined boundary condition is treated as a **wall**. These faces are collected by the converter and put into a **defaultFaces** patch in the OpenFOAM mesh and given the type **wall**; of course, the patch type can be subsequently changed.

Like, OpenFOAM 2 dimensional geometries in CFX are created as 3 dimensional meshes of 1 cell thickness [*\*\**]. If a user wishes to run a 2 dimensional case on a mesh created by CFX, the boundary condition on the front and back planes should be set to **empty**; the user should ensure that the boundary conditions on all other faces in the plane of the calculation are set correctly. Currently there is no facility for creating an axi-symmetric geometry from a 2 dimensional CFX mesh.

The procedure of converting a CFX.*geo* file is first to create a new OpenFOAM case, then at a command prompt, the user should execute:

```
cfx4ToFoam <meshFile>
```

where *<meshFile>* is the name of the *.geo* file, including the full or relative path.

## 5.6 Mapping fields between different geometries

The *mapFields* utility maps one or more fields relating to a given geometry onto the

### 5.6.1 Mapping consistent fields

A mapping of consistent fields is simply performed by executing `mapFields` on the (target) case using the `-consistent` command line option as follows:

```
mapFields <source dir> -consistent
```

### 5.6.2 Mapping inconsistent fields

When the fields are not consistent, as shown in [Figure 5.17](#), `mapFields` requires a `mapFieldsDict` dictionary in the `system` directory of the target case. The following rules apply to the mapping:

- the field data is mapped from source to target wherever possible, *i.e.* in our example all the field data within the target geometry is mapped from the source, except those in the shaded region which remain unaltered;
- the patch field data is left unaltered unless specified otherwise in the `mapFieldsDict` dictionary.

The `mapFieldsDict` dictionary contain two lists that specify mapping of patch data. The first list is `patchMap` that specifies mapping of data between pairs of source and target patches that are geometrically coincident, as shown in [Figure 5.17](#). The list contains each pair of names of source and target patch. The second list is `cuttingPatches` that contains names of target patches whose values are to be mapped from the source internal field through which the target patch cuts. In the situation where the target patch only cuts through part of the source internal field, *e.g.* bottom left target patch in our example, those values within the internal field are mapped and those outside remain unchanged. An example `mapFieldsDict` dictionary is shown below:

```
17
18 patchMap      ( lid movingWall );
19
20 cuttingPatches ( fixedWalls );
21
22
23 // ***** //
```

```
mapFields <source dir>
```

### 5.6.3 Mapping parallel cases

If either or both of the source and target cases are decomposed for running in parallel, additional options must be supplied when executing `mapFields`:

`-parallelSource` if the source case is decomposed for parallel running;

`-parallelTarget` if the target case is decomposed for parallel running.

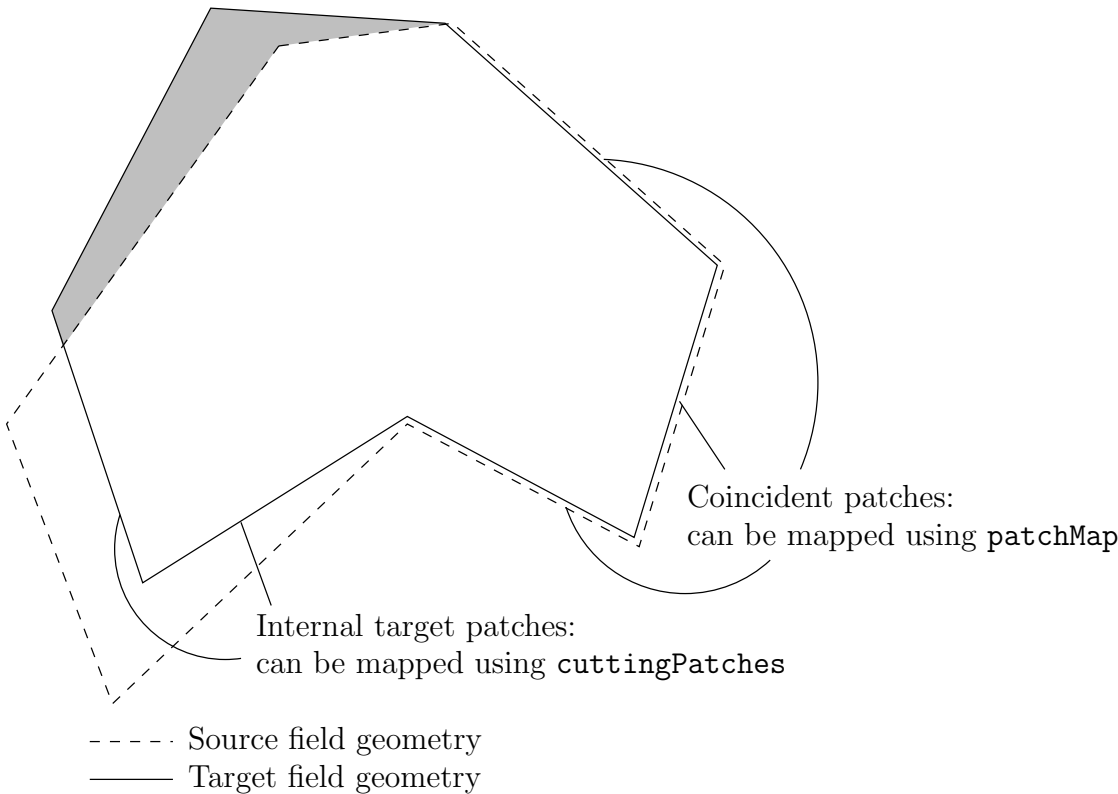

Figure 5.17: Mapping inconsistent fields



# Chapter 6

## Post-processing

This chapter describes options for post-processing with OpenFOAM. OpenFOAM is supplied with a post-processing utility `paraFoam` that uses `ParaView`, an open source visualisation application described in [section 6.1](#).

Other methods of post-processing using third party products are offered, including `EnSight`, `Fieldview` and the post-processing supplied with `Fluent`.

### 6.1 `paraFoam`

The main post-processing tool provided with OpenFOAM is the a reader module to run with `ParaView`, an open-source, visualization application. The module is compiled into 2 libraries, `PV3FoamReader` and `vtkPV3Foam` using version 3.6.1 of `ParaView` supplied with the OpenFOAM release (`PVFoamReader` and `vtkFoam` in `ParaView` version 2.x). It is recommended that this version of `ParaView` is used, although it is possible that the latest binary release of the software will run adequately. Further details about `ParaView` can be found at <http://www.paraview.org> and further documentation is available at <http://www.kitware.com/products/paraviewguide.html>.

`ParaView` uses the Visualisation Toolkit (VTK) as its data processing and rendering engine and can therefore read any data in VTK format. OpenFOAM includes the `foamToVTK` utility to convert data from its native format to VTK format, which means that any VTK-based graphics tools can be used to post-process OpenFOAM cases. This provides an alternative means for using `ParaView` with OpenFOAM. For users who wish to experiment with advanced, parallel visualisation, there is also the free `VisIt` software, available at <http://www.llnl.gov/visit>.

In summary, we recommend the reader module for `ParaView` as the primary post-processing tool for OpenFOAM. Alternatively OpenFOAM data can be converted into VTK format to be read by `ParaView` or any other VTK -based graphics tools.

#### 6.1.1 Overview of `paraFoam`

`paraFoam` is strictly a script that launches `ParaView` using the reader module supplied with OpenFOAM. It is executed like any of the OpenFOAM utilities either by the single command from within the case directory or with the `-case` option with the case path as an argument, *e.g.*:

```
paraFoam -case <caseDir>
```

`ParaView` is launched and opens the window shown in [Figure 6.1](#). The case is controlled from the left panel, which contains the following:

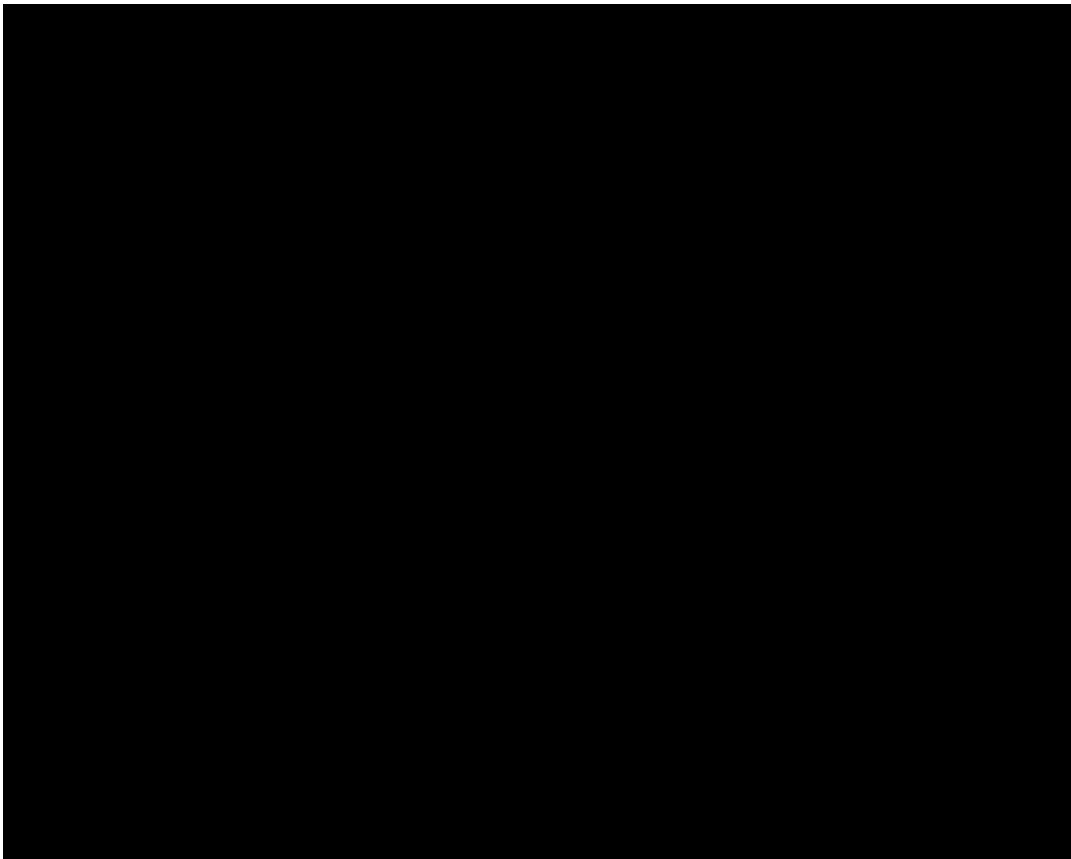

Figure 6.1: The paraFoam window

**Pipeline Browser** lists the *modules* opened in ParaView, where the selected modules are highlighted in blue and the graphics for the given module can be enabled/disabled by clicking the **eye** button alongside;

**Properties panel** contains the input selections for the case, such as times, regions and fields;

**Display panel** controls the visual representation of the selected module, *e.g.* colours;

**Information panel** gives case statistics such as mesh geometry and size.

ParaView operates a tree-based structure in which data can be filtered from the top-level case module to create sets of sub-modules. For example, a contour plot of, say, pressure could be a sub-module of the case module which contains all the pressure data. The strength of ParaView is that the user can create a number of sub-modules and display whichever ones they feel to create the desired image or animation. For example, they may add some solid geometry, mesh and velocity vectors, to a contour plot of pressure, switching any of the items on and off as necessary.

The general operation of the system is based on the user making a selection and then clicking the green **Apply** button in the **Properties** panel. The additional buttons are: the **Reset**



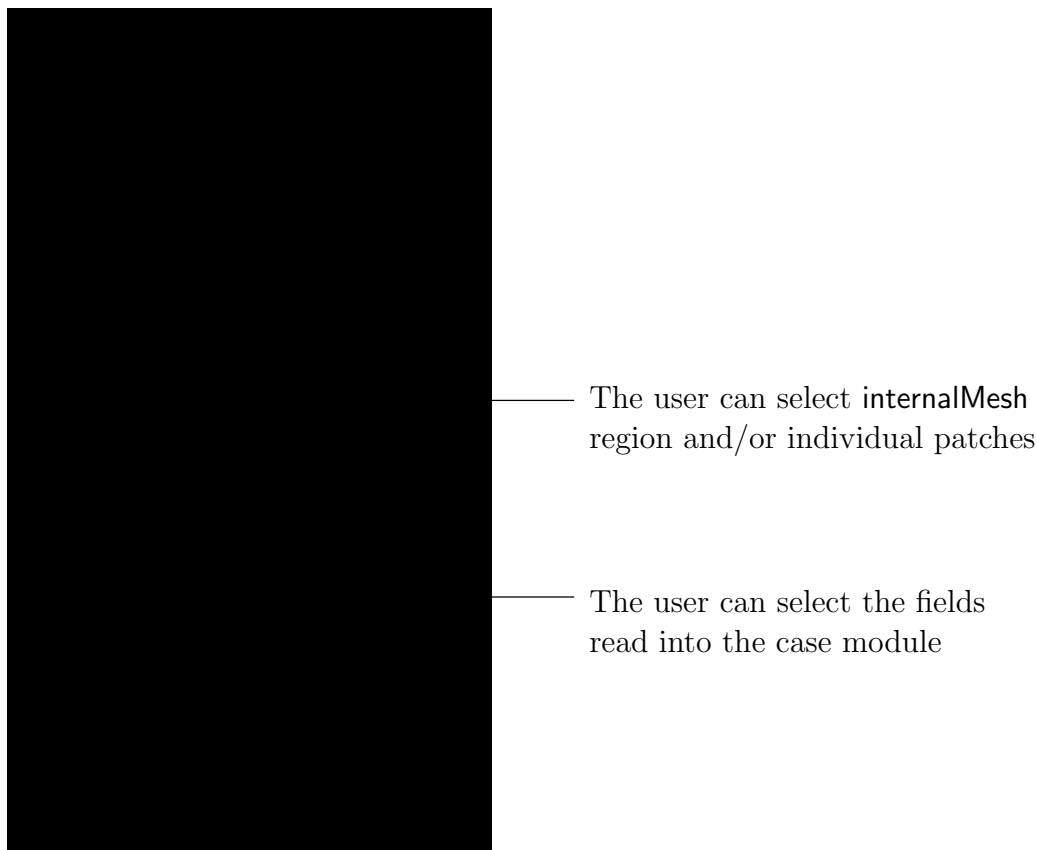

Figure 6.2: The Properties panel for the case module

in the current reader module, data in all time directories are loaded into ParaView (in the reader module for ParaView 2.x, a set of check boxes controlled the time that were displayed). In the current reader module, the buttons in the **Current Time Controls** and **VCR Controls** toolbars select the time data to be displayed, as shown in [section 6.1.4](#).

As with any operation in paraFoam, the user must click **Apply** after making any changes to any selections. The **Apply** button is highlighted in green to alert the user if changes have been made but not accepted. This method of operation has the advantage of allowing the user to make a number of selections before accepting them, which is particularly useful in large cases where data processing is best kept to a minimum.

There are occasions when the case data changes on file and ParaView needs to load the changes, *e.g.* when field data is written into new time directories. To load the changes, the user should check the **Update GUI** button at the top of the **Properties** panel and then apply the changes.

### 6.1.3 The Display panel

The **Display** panel contains the settings for visualising the data for a given case module. The following points are particularly important:

- the data range may not be automatically updated to the max/min limits of a field, so the user should take care to select **Rescale to Data Range** at appropriate intervals, in particular after loading the initial case module;
- clicking the **Edit Color Map** button, brings up a window in which there are two panels:

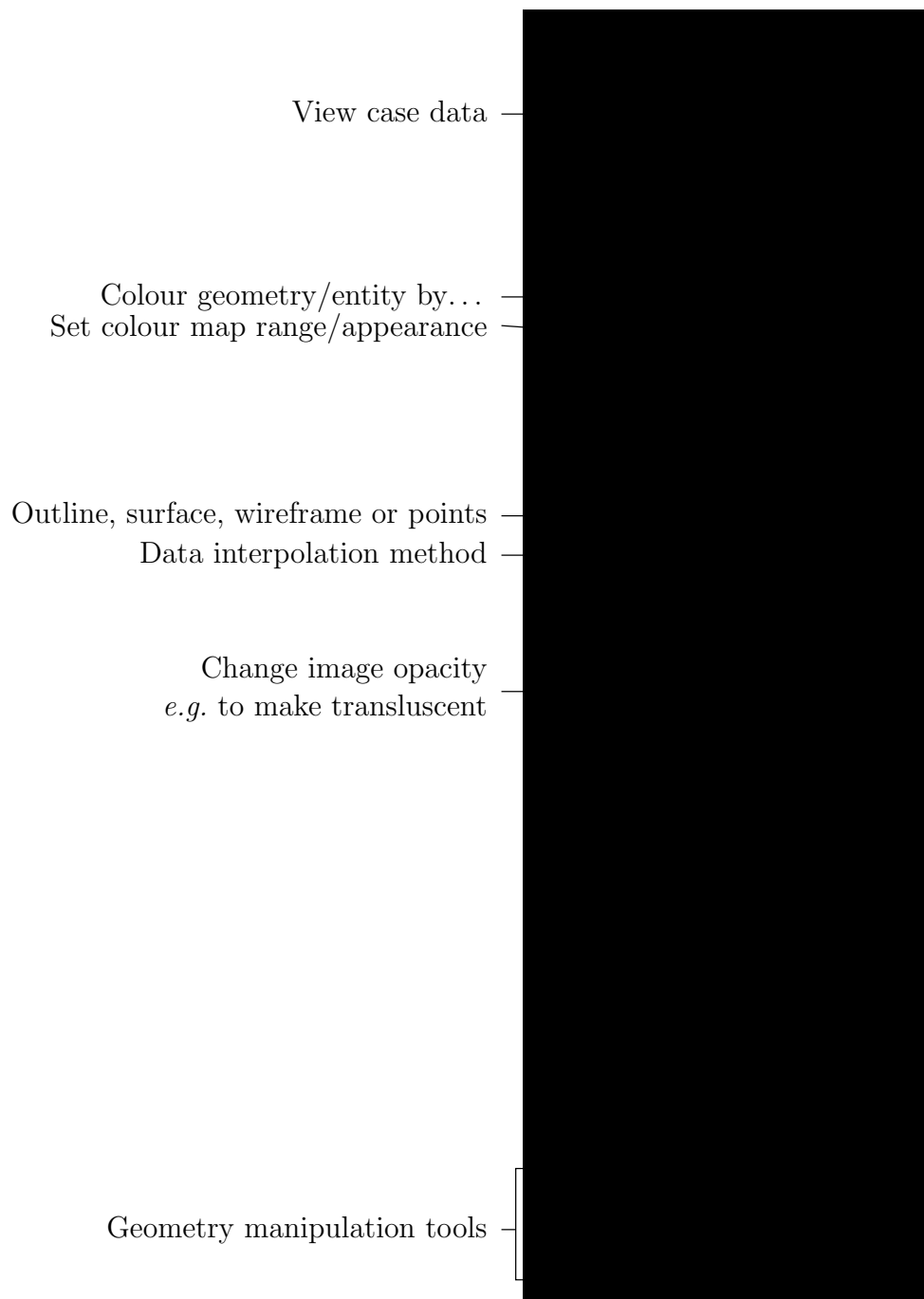

Figure 6.3: The Display panel

1. The **Color Scale** panel in which the colours within the scale can be chosen. The standard blue to red colour scale for CFD can be selected by clicking **Choose Preset** and selecting **Blue to Red Rainbow HSV**.
  2. The **Color Legend** panel has a toggle switch for a colour bar legend and contains settings for the layout of the legend, *e.g.* font.
- the underlying mesh can be represented by selecting **Wireframe** in the **Representation** menu of the **Style** panel;
  - the geometry, *e.g.* a mesh (if **Wireframe** is selected), can be visualised as a single colour by selecting **Solid Color** from the **Color By** menu and specifying the colour in the **Set Solid Color** window;

- the image can be made translucent by editing the value in the **Opacity** text box (1 = solid, 0 = invisible) in the **Style** panel.

### 6.1.4 The button toolbars

ParaView duplicates functionality from pull-down menus at the top of the main window and the major panels, within the toolbars below the main pull-down menus. The displayed toolbars can be selected from **Toolbars** in the main **View** menu. The default layout with all toolbars is shown in **Figure 6.4** with each toolbar labelled. The function of many of the buttons is clear from their icon and, with tooltips enabled in the **Help** menu, the user is given a concise description of the function of any button.

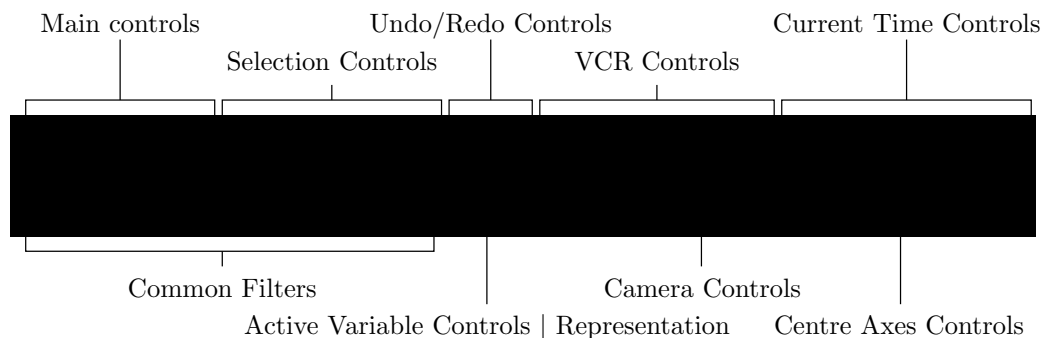

Figure 6.4: Toolbars in ParaView

### 6.1.5 Manipulating the view

This section describes operations for setting and manipulating the view of objects in paraFoam.

#### 6.1.5.1 View settings

The **View Settings** are selected from the **Edit** menu, which opens a **Render View Options** window with a table of 3 items: **General**, **Lights** and **Annotation**. The **General** panel includes the following items which are **often worth setting at startup**:

- the background colour, where white is often a preferred choice for printed material;
- Use parallel projection which is the usual choice for CFD, especially for 2D cases;

The **Lights** panel contains detailed lighting controls within the **Light Kit** panel. A separate **Headlight** panel controls the direct lighting of the image. Checking the **Headlight** button with white light colour of strength 1 seems to help produce images with strong bright colours, e.g. with an isosurface.

The **Annotation** panel includes options for including annotations in the image. The **Orientation Axes** feature controls an axes icon in the image window, e.g. to set the colour of the axes labels  $x$ ,  $y$  and  $z$ .

#### 6.1.5.2 General settings

The general **Settings** are selected from the **Edit** menu, which opens a general **Options** window with **General** and **Render View** menu items.

The **General** panel controls some default behaviour of ParaView. In particular, there is an **Auto Accept** button that enables ParaView to accept changes automatically without

clicking the green **Apply** button in the **Properties** window. For larger cases, this option is generally not recommended: the user does not generally want the image to be re-rendered between each of a number of changes he/she selects, but be able to apply a number of changes to be re-rendered in their entirety once.

The **Render View** panel contains 3 sub-items: **General**, **Camera** and **Server**. The **General** panel includes the level of detail (LOD) which controls the rendering of the image while it is being manipulated, *e.g.* translated, resized, rotated; lowering the levels set by the sliders, allows cases with large numbers of cells to be re-rendered quickly during manipulation.

The **Camera** panel includes control settings for 3D and 2D movements. This presents the user with a map of rotation, translate and zoom controls using the mouse in combination with Shift- and Control-keys. The map can be edited to suit by the user.

## 6.1.6 Contour plots

A contour plot is created by selecting **Contour** from the **Filter** menu at the top menu bar. The filter acts on a given module so that, if the module is the 3D case module itself, the contours will be a set of 2D surfaces that represent a constant value, *i.e.* isosurfaces. The **Properties** panel for contours contains an **Isosurfaces** list that the user can edit, most conveniently by the **New Range** window. The chosen scalar field is selected from a pull down menu.

### 6.1.6.1 Introducing a cutting plane

Very often a user will wish to create a contour plot across a plane rather than producing isosurfaces. To do so, the user must first use the **Slice** filter to create the cutting plane, on which the contours can be plotted. The **Slice** filter allows the user to specify a cutting **Plane**, **Box** or **Sphere** in the **Slice Type** menu by a **center** and **normal/radius** respectively. The user can manipulate the cutting plane like any other using the mouse.

The user can then run the **Contour** filter on the cut plane to generate contour lines.

## 6.1.7 Vector plots

Vector plots are created using the **Glyph** filter. The filter reads the field selected in **Vectors** and offers a range of **Glyph Types** for which the **Arrow** provides a clear vector plot images. Each glyph has a selection of graphical controls in a panel which the user can manipulate to best effect.

The remainder of the **Properties** panel contains mainly the **Scale Mode** menu for the glyphs. The most common options are **Scale Mode** are: **Vector**, where the glyph length is proportional to the vector magnitude; and, **Off** where each glyph is the same length. The **Set Scale Factor** parameter controls the base length of the glyphs.

### 6.1.7.1 Plotting at cell centres

Vectors are by default plotted on cell vertices but, very often, we wish to plot data at cell centres. This is done by first applying the **Cell Centers** filter to the case module, and then applying the **Glyph** filter to the resulting cell centre data.

## 6.1.8 Streamlines

Streamlines are created by first creating tracer lines using the **Stream Tracer** filter. The tracer **Seed** panel specifies a distribution of tracer points over a **Line Source** or **Point**

**Cloud.** The user can view the tracer source, *e.g.* the line, but it is displayed in white, so they may need to change the background colour in order to see it.

The distance the tracer travels and the length of steps the tracer takes are specified in the text boxes in the main **Stream Tracer** panel. The process of achieving desired tracer lines is largely one of trial and error in which the tracer lines obviously appear smoother as the step length is reduced but with the penalty of a longer calculation time.

Once the tracer lines have been created, the **Tubes** filter can be applied to the *Tracer* module to produce high quality images. The tubes follow each tracer line and are not strictly cylindrical but have a fixed number of sides and given radius. When the number of sides is set above, say, 10, the tubes do however appear cylindrical, but again this adds a computational cost.

### 6.1.9 Image output

The simplest way to output an image to file from **ParaView** is to select **Save Screenshot** from the **File** menu. On selection, a window appears in which the user can select the resolution for the image to save. There is a button that, when clicked, locks the aspect ratio, so if the user changes the resolution in one direction, the resolution is adjusted in the other direction automatically. After selecting the pixel resolution, the image can be saved. To achieve high quality output, the user might try setting the pixel resolution to 1000 or more in the *x*-direction so that when the image is scaled to a typical size of a figure in an A4 or US letter document, perhaps in a PDF document, the resolution is sharp.

### 6.1.10 Animation output

To create an animation, the user should first select **Save Animation** from the **File** menu. A dialogue window appears in which the user can specify a number of things including the image resolution. The user should specify the resolution as required. The other noteworthy setting is number of frames per timestep. While this would intuitively be set to 1, it can be set to a larger number in order to introduce more frames into the animation artificially. This technique can be particularly useful to produce a slower animation because some movie players have limited speed control, particularly over **mpeg** movies.

On clicking the **Save Animation** button, another window appears in which the user specifies a file name *root* and file format for a set of images. On clicking **OK**, the set of files will be saved according to the naming convention “<fileRoot>\_<imageNo>.<fileExt>”, *e.g.* the third image of a series with the file root “**animation**”, saved in **jpg** format would be named “**animation\_0002.jpg**” (<imageNo> starts at 0000).

Once the set of images are saved the user can convert them into a movie using their software of choice. The **convert** utility in the **ImageMagick** package can do this from the command line, *e.g.* by

```
convert animation*.jpg movie.mpg
```

When creating an **mpg** movie it can be worth increasing the default quality setting, *e.g.* with **-quality 90%**, to reduce the graininess that can occur with the default setting.

## 6.2 Post-processing with Fluent

It is possible to use **Fluent** as a post-processor for the cases run in **OpenFOAM**. Two converters are supplied for the purpose: `foamMeshToFluent` which converts the **OpenFOAM** mesh into **Fluent** format and writes it out as a `.msh` file; and, `foamDataToFluent` converts the **OpenFOAM** results data into a `.dat` file readable by **Fluent**. `foamMeshToFluent` is executed in the usual manner. The resulting mesh is written out in a `fluentInterface` subdirectory of the case directory, *i.e.* `<caseName>/fluentInterface/<caseName>.msh`

`foamDataToFluent` converts the **OpenFOAM** data results into the **Fluent** format. The conversion is controlled by two files. First, the `controlDict` dictionary specifies `startTime`, giving the set of results to be converted. If you want to convert the latest result, `startFrom` can be set to `latestTime`. The second file which specifies the translation is the `foamDataToFluentDict` dictionary, located in the `constant` directory. An example `foamDataToFluentDict` dictionary is given below:

```

1  /*----- C++ -----*/
2  |=====|
3  | \ \ \ \ \ \ \ \ \ \ | F i e l d           | OpenFOAM: The Open Source CFD Toolbox
4  | \ \ \ \ \ \ \ \ \ \ | O p e r a t i o n       | Version: 1.6
5  | \ \ \ \ \ \ \ \ \ \ | A n d                 | Web:      www.OpenFOAM.org
6  | \ \ \ \ \ \ \ \ \ \ | M a n i p u l a t i o n   |
7  /*-----*/
8  FoamFile
9  {
10     version      2.0;
11     format       ascii;
12     class        dictionary;
13     location     "system";
14     object       foamDataToFluentDict;
15 }
16 // ***** //
17
18 p          1;
19
20 U          2;
21
22 T          3;
23
24 h          4;
25
26 k          5;
27
28 epsilon    6;
29
30 gamma      150;
31
32
33 // ***** //

```

The dictionary contains entries of the form

```
<fieldName> <fluentUnitNumber>
```

The `<fluentUnitNumber>` is a label used by the **Fluent** post-processor that only recognises a fixed set of fields. The basic set of `<fluentUnitNumber>` numbers are quoted in [Table 6.1](#). The dictionary must contain all the entries the user requires to post-process, *e.g.* in our example we have entries for pressure `p` and velocity `U`. The list of default entries described in [Table 6.1](#). The user can run `foamDataToFluent` like any utility.

To view the results using **Fluent**, go to the `fluentInterface` subdirectory of the case directory and start a 3 dimensional version of **Fluent** with

```
fluent 3d
```

The mesh and data files can be loaded in and the results visualised. The mesh is read by selecting `Read Case` from the `File` menu. Support items should be selected to read

Fluent name	Unit number	Common OpenFOAM name
PRESSURE	1	p
MOMENTUM	2	U
TEMPERATURE	3	T
ENTHALPY	4	h
TKE	5	k
TED	6	epsilon
SPECIES	7	—
G	8	—
XF_RF_DATA_VOF	150	gamma
TOTAL_PRESSURE	192	—
TOTAL_TEMPERATURE	193	—

Table 6.1: Fluent unit numbers for post-processing.

certain data types, *e.g.* to read turbulence data for **k** and **epsilon**, the user would select **k-epsilon** from the **Define->Models->Viscous** menu. The data can then be read by selecting **Read Data** from the **File** menu.

A note of caution: users **MUST NOT** try to use an original **Fluent** mesh file that has been converted to OpenFOAM format in conjunction with the OpenFOAM solution that has been converted to **Fluent** format since the alignment of zone numbering cannot be guaranteed.

## 6.3 Post-processing with Fieldview

OpenFOAM offers the capability for post-processing OpenFOAM cases with **Fieldview**. The method involves running a post-processing utility **foamToFieldview** to convert case data from OpenFOAM to **Fieldview.uns** file format. For a given case, **foamToFieldview** is executed like any normal application. **foamToFieldview** creates a directory named **Fieldview** in the case directory, *deleting any existing Fieldview directory in the process*. By default the converter reads the data in all time directories and writes into a set of files of the form **<case>\_nn.uns**, where *nn* is an incremental counter starting from 1 for the first time directory, 2 for the second and so on. The user may specify the conversion of a single time directory with the option **-time <time>**, where **<time>** is a time in general, scientific or fixed format.

**Fieldview** provides certain functions that require information about boundary conditions, *e.g.* drawing streamlines that uses information about wall boundaries. The converter tries, wherever possible, to include this information in the converted files by default. The user can disable the inclusion of this information by using the **-noWall** option in the execution command.

The data files for **Fieldview** have the **.uns** extension as mentioned already. If the original OpenFOAM case includes a dot '.', **Fieldview** may have problems interpreting a set of data files as a single case with multiple time steps.

## 6.4 Post-processing with EnSight

OpenFOAM offers the capability for post-processing OpenFOAM cases with **EnSight**, with a choice of 2 options:

- converting the OpenFOAM data to EnSight format with the `foamToEnSight` utility;
- reading the OpenFOAM data directly into EnSight using the `ensight74FoamExec` module.

### 6.4.1 Converting data to EnSight format

The `foamToEnSight` utility converts data from OpenFOAM to EnSight file format. For a given case, `foamToEnSight` is executed like any normal application. `foamToEnSight` creates a directory named *EnSight* in the case directory, *deleting any existing EnSight directory in the process*. The converter reads the data in all time directories and writes into a case file and a set of data files. The case file is named *EnSight\_Case* and contains details of the data file names. Each data file has a name of the form *EnSight\_nn.ext*, where *nn* is an incremental counter starting from 1 for the first time directory, 2 for the second and so on and *ext* is a file extension of the name of the field that the data refers to, as described in the case file, *e.g.* `T` for temperature, `mesh` for the mesh. Once converted, the data can be read into EnSight by the normal means:

1. from the EnSight GUI, the user should select **Data (Reader)** from the **File** menu;



Environment variable	Description and options
\$CEI_HOME	Path where EnSight is installed, eg <i>/usr/local/ensight</i> , added to the system path by default
\$CEI_ARCH	Machine architecture, from a choice of names corresponding to the machine directory names in <i>\$CEI_HOME/ensight74/machines</i> ; default settings include <i>linux_2.4</i> and <i>sgi_6.5_n32</i>
\$ENSIGHT7_READER	Path that EnSight searches for the user defined libuserd-foam reader library, set by default to \$FOAM_LIBBIN
\$ENSIGHT7_INPUT	Set by default to <i>dummy</i>

Table 6.2: Environment variable settings for EnSight.

3. The user should find their case directory from the File Selection window, highlight one of top 2 entries in the Directories box ending in */.* or */..* and click (Set) Geometry.
4. The path field should now contain an entry for the case. The (Set) Geometry text box should contain a *'/*.
5. The user may now click Okay and EnSight will begin reading the data.
6. When the data is read, a new Data Part Loader window will appear, asking which part(s) are to be read. The user should select Load all.
7. When the mesh is displayed in the EnSight window the user should close the Data Part Loader window, since some features of EnSight will not work with this window open.

```

34  surfaces      ();
35
36  fields       ( sigmaxx );
37
38
39  // ***** //

```

Keyword	Options	Description
interpolation-	cell	Cell-centre value assumed constant over cell
Scheme	cellPoint	Linear weighted interpolation using cell values
	cellPointFace	Mixed linear weighted / cell-face interpolation
setFormat	raw	
	gnuplot	
	xmgr	
	jplot	

The `setFormat` entry for line sampling includes a raw data format and formats for `gnuplot`, `Grace/xmgr` and `jPlot` graph drawing packages. The data are written into a `sets` directory within the case directory. The directory is split into a set of time directories and the data files are contained therein. Each data file is given a name containing the field name, the sample set name, and an extension relating to the output format, including `.xy` for raw data, `.agr` for `Grace/xmgr` and `.dat` for `jPlot`. The `gnuplot` format has the data in raw form with an additional commands file, with `.gplt` extension, for generating the graph. *Note that any existing `sets` directory is deleted when `sample` is run.*

The `surfaceFormat` entry for surface sampling includes a raw data format and formats for `gnuplot`, `Grace/xmgr` and `jPlot` graph drawing packages. The data are written into a `surfaces` directory within the case directory. The directory is split into time directories and files are written much as with line sampling.

The `fields` list contains the fields that the user wishes to sample. The `sample` utility can parse the following restricted set of functions to enable the user to manipulate vector and tensor fields, *e.g.* for `U`:

`U.component(n)` writes the *n*th component of the vector/tensor,  $n = 0, 1 \dots$ ;

`mag(U)` writes the magnitude of the vector/tensor.

The `sets` list contains sub-dictionaries of locations where the data is to be sampled. The sub-dictionary is named according to the name of the set and contains a set of entries, also listed in [Table 6.4](#), that describes the locations where the data is to be sampled. For example, a `uniform` sampling provides a uniform distribution of `nPoints` sample locations along a line specified by a `start` and `end` point. All sample sets are also given: a `type`; and, means of specifying the length ordinate on a graph by the `axis` keyword.

Sampling type	Sample locations	Required entries					
		name	axis	start	end	nPoints	points
<code>uniform</code>	Uniformly distributed points on a line	•	•	•	•	•	
<code>face</code>	Intersection of specified line and cell faces	•	•	•	•		
<code>midPoint</code>	Midpoint between line-face intersections	•	•	•	•		
<code>midPointAndFace</code>	Combination of <code>midPoint</code> and <code>face</code>	•	•	•	•		
<code>curve</code>	Specified points, tracked along a curve	•	•				•
<code>cloud</code>	Specified points	•	•				•

Entries	Description	Options
<code>type</code>	Sampling type	see list above
<code>axis</code>	Output of sample location	<code>x</code> $x$ ordinate <code>y</code> $y$ ordinate <code>z</code> $z$ ordinate <code>xyz</code> $xyz$ coordinates <code>distance</code> distance from point 0
<code>start</code>	Start point of sample line	<i>e.g.</i> (0.0 0.0 0.0)
<code>end</code>	End point of sample line	<i>e.g.</i> (0.0 2.0 0.0)
<code>nPoints</code>	Number of sampling points	<i>e.g.</i> 200
<code>points</code>	List of sampling points	

Table 6.4: Entries within `sets` sub-dictionaries.

Keyword	Description	Options
basePoint	Point on plane	<i>e.g.</i> (0 0 0)
normalVector	Normal vector to plane	<i>e.g.</i> (1 0 0)
interpolate	Interpolate data?	true/false
triangulate	Triangulate surface? (optional)	true/false

Table 6.5: Entries for a `plane` in `surfaces` sub-dictionaries.

Keyword	Description	Options
patchName	Name of patch	<i>e.g.</i> movingWall
interpolate	Interpolate data?	true/false
triangulate	Triangulate surface? (optional)	true/false

Table 6.6: Entries for a `patch` in `surfaces` sub-dictionaries.

The `surfaces` list contains sub-dictionaries of locations where the data is to be sampled. The sub-dictionary is named according to the name of the surface and contains a set of entries beginning with the `type`: either a `plane`, defined by point and normal direction, with additional sub-dictionary entries as specified in [Table 6.5](#); or, a `patch`, coinciding with an existing boundary patch, with additional sub-dictionary entries as specified in [Table 6.6](#).

## 6.6 Monitoring and managing jobs

This section is concerned primarily with successful running of OpenFOAM jobs and extends on the basic execution of solvers described in [section 3.3](#). When a solver is executed, it reports the status of equation solution to standard output, *i.e.* the screen, if the `level` debug switch is set to 1 or 2 (default) in `DebugSwitches` in the `$WM_PROJECT_DIR/etc/controlDict` file. An example from the beginning of the solution of the cavity tutorial is shown below where it can be seen that, for each equation that is solved, a report line is written with the solver name, the variable that is solved, its initial and final residuals and number of iterations.

```

Solving for 0
. . .
M o n i t o r i n g
B^ # So ng o , n , n 6338 6, 6
^ # So ng o , n , n 336 6, 6
^ # So ng o , n , n 376 , g o -6 6, c -6 6
^ # So ng o , n , n 68 6, n 3
^ # So ng o , n , n 6 6, g o -6 6, c -6 6
c on
. . .
M o n i t o r i n g
B^ # So ng o , n , n 6
B^ # So ng o , n , n 6
^ # So ng o , n , n 6 6, n 33
^ # So ng o , n , n 3 3, g o 6 3 - , c 66
^ # So ng o , n , n 3 6 3 6 6, n 33
^ # So ng o , n , n 3 6 6 6, g o -6 6, c 6 6
c on
. . .

```



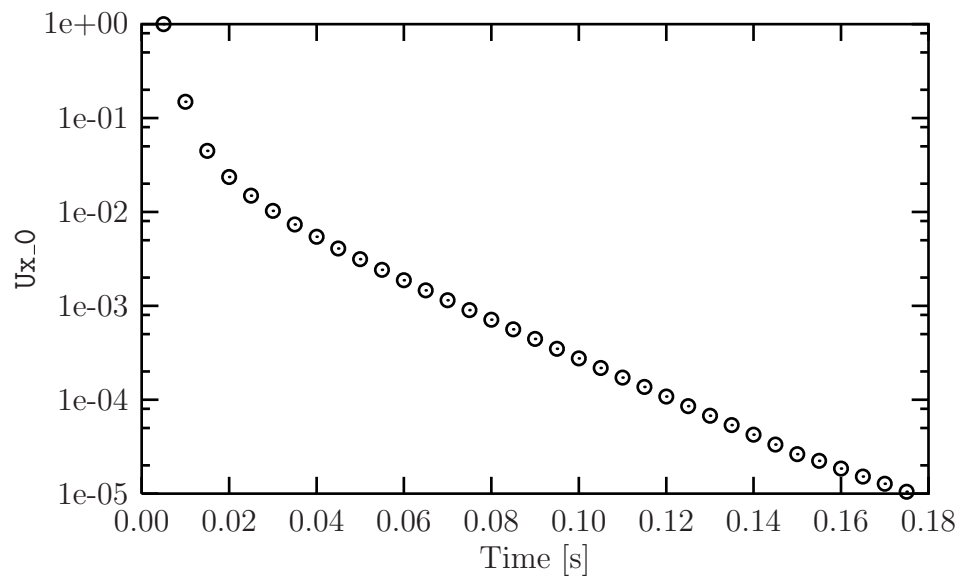

Figure 6.5: Initial residual of  $U_x$  in the cavity tutorial

- cumulative, global and local continuity errors after each of the 2 p equations, `contCumulative_0`, `contGlobal_0`, `contLocal_0` and `contCumulative_1`, `contGlobal_1`, `contLocal_1`;
- residuals and iterations from the the 2 p equations `p_0`, `pFinalRes_0`, `pIters_0` and `p_1`, `pFinalRes_1`, `pIters_1`;
- and execution time, `executionTime`.

# Chapter 7

## Models and physical properties

OpenFOAM includes a large range of solvers each designed for a specific class of problem. The equations and algorithms differ from one solver to another so that the selection of a solver involves the user making some initial choices on the modelling for their particular case. The choice of solver typically involves scanning through their descriptions in [Table 3.5](#) to find the one suitable for the case. It ultimately determines many of the parameters and physical properties required to define the case but leaves the user with some modelling options that can be specified at runtime through the entries in dictionary files in the *constant* directory of a case. This chapter deals with many of the more common models and associated properties that may be specified at runtime.

### 7.1 Thermophysical models

Thermophysical models are concerned with the energy, heat and physical properties.

The *thermophysicalProperties* dictionary is read by any solver that uses the thermophysical model library. A thermophysical model is constructed in OpenFOAM as a pressure-temperature  $p - T$  system from which other properties are computed. There is one compulsory dictionary entry called `thermoType` which specifies the complete thermophysical model that is used in the simulation. The thermophysical modelling starts with a layer that defines the basic equation of state and then adds more layers of modelling that derive properties from the previous layer(s). The naming of the `thermoType` reflects these multiple layers of modelling as listed in [Table 7.1](#).

---

#### Equation of State — equationOfState

icoPolynomial	Incompressible polynomial equation of state, <i>e.g.</i> for liquids
perfectGas	Perfect gas equation of state

---

#### Basic thermophysical properties — thermo

eConstThermo	Constant specific heat $c_p$ model with evaluation of internal energy $e$ and entropy $s$
hConstThermo	Constant specific heat $c_p$ model with evaluation of enthalpy $h$ and entropy $s$
hPolynomialThermo	$c_p$ evaluated by a function with coefficients from polynomials, from which $h$ , $s$ are evaluated
janafThermo	$c_p$ evaluated by a function with coefficients from JANAF thermodynamic tables, from which $h$ , $s$ are evaluated

---

#### Derived thermophysical properties — specieThermo

*Continued on next page*

*Continued from previous page*

specieThermo	Thermophysical properties of species, derived from $c_p$ , $h$ and/or $s$
<b>Transport properties — transport</b>	
constTransport	Constant transport properties
polynomialTransport	Polynomial based temperature-dependent transport properties
sutherlandTransport	Sutherland's formula for temperature-dependent transport properties
<b>Mixture properties — mixture</b>	
pureMixture	General thermophysical model calculation for passive gas mixtures
homogeneousMixture	Combustion mixture based on normalised fuel mass fraction $b$
inhomogeneousMixture	Combustion mixture based on $b$ and total fuel mass fraction $f_t$
veryInhomogeneousMixture	Combustion mixture based on $b$ , $f_t$ and unburnt fuel mass fraction $f_u$
dieselMixture	Combustion mixture based on $f_t$ and $f_u$
basicMultiComponentMixture	Basic mixture based on multiple components
multiComponentMixture	Derived mixture based on multiple components
reactingMixture	Combustion mixture using thermodynamics and reaction schemes
egrMixture	Exhaust gas recirculation mixture
<b>Thermophysical model — thermoModel</b>	
hPsiThermo	General thermophysical model calculation based on enthalpy $h$ and compressibility $\psi$
ePsiThermo	General thermophysical model calculation based on internal energy $e$ and compressibility $\psi$
hRhoThermo	General thermophysical model calculation based on enthalpy $h$
hPsiMixtureThermo	Calculates enthalpy for combustion mixture based on $\psi$
hRhoMixtureThermo	Calculates enthalpy for combustion mixture based on $\rho$
hhuMixtureThermo	Calculates enthalpy for unburnt gas and combustion mixture

Table 7.1: Layers of thermophysical modelling.

The thermoType entry typically takes the form:

```
thermoModel<mixture<transport<specieThermo<thermo<equationOfState>>>>>
```

so that the following is an example entry for thermoType:

```
hThermo<pureMixture<constTransport<specieThermo<hConstThermo<perfectGas>>>>>
```



### 7.1.1 Thermophysical property data

The basic thermophysical properties are specified for each species from input data. The data is specified using a compound entry with the following format for a specie accessed through the keyword `mixture`:

```
mixture <specieCoeffs> <thermoCoeffs> <transportCoeffs>
```

The specie coefficients `<specieCoeffs>` contains the entries listed in [Table 7.2](#) in the order that they are specified in input.

Description	Entry
String name	<i>e.g.</i> <code>mixture</code>
Number of moles of this specie	<i>n<sub>moles</sub></i>
Molecular weight	<i>W</i> (kg/kmol)

Table 7.2: Specie coefficients.

The thermodynamic coefficients `<thermoCoeffs>` are ostensibly concerned with evaluating the specific heat  $c_p$  from which other properties are derived. The current thermo models are described as follows:

`hConstThermo` assumes a constant  $c_p$  and a heat of fusion  $H_f$  which is simply specified by a two values  $c_p H_f$  following the `<specieCoeffs>`.

`eConstThermo` assumes a constant  $c_v$  and a heat of fusion  $H_f$  which is simply specified by a two values  $c_v H_f$  following the `<specieCoeffs>`.

`janafThermo` calculates  $c_p$  as a function of temperature  $T$  from a set of coefficients taken from JANAF tables of thermodynamics. The ordered list of coefficients is given in [Table 7.3](#). The function is valid between a lower and upper limit in temperature  $T_l$  and  $T_h$  respectively. Two sets of coefficients are specified, the first set for temperatures above a common temperature  $T_c$  (and below  $T_h$ , the second for temperatures below  $T_c$  (and above  $T_l$ ). The function relating  $c_p$  to temperature is:

$$c_p = R(((a_4 T + a_3)T + a_2)T + a_1)T + a_0 \quad (7.1)$$

In addition, there are constants of integration,  $a_5$  and  $a_6$ , both at high and low temperature, used to evaluating  $h$  and  $s$  respectively.

`hPolynomialThermo` calculates  $C_p$  as a function of temperature by a polynomial of any order. The following case provides an example of its use: `$FOAM_TUTORIALS/lagrangian/porous-ExplicitSourceReactingParcelFoam/filter`

The transport coefficients `<transportCoeffs>` are used to to evaluate dynamic viscosity  $\mu$ , thermal conductivity  $\kappa$  and laminar thermal conductivity (for enthalpy equation)  $\alpha$ . The current transport models are described as follows:

`constTransport` assumes a constant  $\mu$  and Prandtl number  $Pr = c_p \mu / \kappa$  which is simply specified by a two values  $\mu Pr$  following the `<thermoCoeffs>`.

`sutherlandTransport` calculates  $\mu$  as a function of temperature  $T$  from a Sutherland coefficient  $A_s$  and Sutherland temperature  $T_s$ , specified by values following the `<thermoCoeffs>`;  $\mu$  is calculated according to:

$$\mu = \frac{A_s \sqrt{T}}{1 + T_s/T} \quad (7.2)$$

Description	Entry
Lower temperature limit	$T_l$ (K)
Upper temperature limit	$T_h$ (K)
Common temperature	$T_c$ (K)
High temperature coefficients	$a_0 \dots a_4$
High temperature enthalpy offset	$a_5$
High temperature entropy offset	$a_6$
Low temperature coefficients	$a_0 \dots a_4$
Low temperature enthalpy offset	$a_5$
Low temperature entropy offset	$a_6$

Table 7.3: JANAF thermodynamic coefficients.

`polynomialTransport` calculates  $\mu$  and  $s$  as a function of temperature  $T$  from a polynomial of any order.

The following is an example entry for a species named `fuel` modelled using `superlandTransport` and `janafThermo`, with comments: `$(g) 0.4307(63)-68.13.8859y25659434(-04-0.3104`

is selected, the choice of LES modelling is specified in a *LESProperties* dictionary and the LES turbulence model is selected by the `LESModel` entry.

The entries required in the *RASProperties* are listed in [Table 7.4](#) and those for *LESProperties* dictionaries are listed in [Table 7.5](#).

<code>RASModel</code>	Name of RAS turbulence model
<code>turbulence</code>	Switch to turn turbulence modelling on/off
<code>&lt;RASModel&gt;Coeffs</code>	Optional dictionary of coefficients for the respective <code>RASModel</code>

Table 7.4: Keyword entries in the *RASProperties* dictionary.

<code>LESmodel</code>	Name of LES model
<code>delta</code>	Name of delta $\delta$ model
<code>&lt;LESmodel&gt;Coeffs</code>	Dictionary of coefficients for the respective <code>LESmodel</code>
<code>&lt;delta&gt;Coeffs</code>	Dictionary of coefficients for each <code>delta</code> model

Table 7.5: Keyword entries in the *LESProperties* dictionary.

The incompressible and compressible RAS turbulence models, isochoric and anisochoric LES models and delta models are all named and described in [Table 3.9](#). Examples of their use can be found in the *\$FOAM\_TUTORIALS*.

### 7.2.1 Model coefficients

The coefficients for the RAS turbulence models are given default values in their respective source code. If the user wishes to override these default values, then they can do so by adding a sub-dictionary entry to the *RASProperties* file, whose keyword name is that of the model with `Coeffs` appended, *e.g.* `kEpsilonCoeffs` for the `kEpsilon` model. If the `printCoeffs` switch is on in the *RASProperties* file, an example of the relevant `...Coeffs` dictionary is printed to standard output when the model is created at the beginning of a run. The user can simply copy this into the *RASProperties* file and edit the entries as required.

### 7.2.2 Wall functions

From version 1.6 onwards, a range of wall function models is available in OpenFOAM that are applied as boundary conditions on individual patches. This enables different wall function models to be applied to different wall regions. The choice of wall function model is specified through:  $\nu_t$  in the *0/nut* file for incompressible RAS;  $\mu_t$  in the *0/mut* file for compressible RAS;  $\nu_{sgs}$  in the *0/nuSgs* file for incompressible LES;  $\mu_{sgs}$  in the *0/muSgs* file for incompressible LES. For example, a *0/nut* file:

```

17
18 dimensions      [0 2 -1 0 0 0 0];
19
20 internalField    uniform 0;
21
22 boundaryField
23 {
24     movingWall
25     {
26         type      nutWallFunction;
27         value      uniform 0;
28     }
29     fixedWalls

```

```

30     {
31         type          nutWallFunction;
32         value         uniform 0;
33     }
34     frontAndBack
35     {
36         type          empty;
37     }
38 }
39
40
41 // ***** //

```

There are a number of wall function models available in the release, *e.g.* `nutWallFunction`, `nutRoughWallFunction`, `nutSpalartAllmarasStandardRoughWallFunction`, `nutSpalartAllmarasStandardWallFunction` and `nutSpalartAllmarasWallFunction`. The user can consult the relevant directories for a full list of wall function models:

```
find $FOAM_SRC/turbulenceModels -name wallFunctions
```

Within each wall function boundary condition the user can over-ride default settings for  $E$  and  $\kappa$  through optional `E` and `kappa` keyword entries.

Having selected the particular wall functions on various patches in the `nut/mut` file, the user should select `epsilonWallFunction` on corresponding patches in the `epsilon` field and `kqRwallFunction` on corresponding patches in the turbulent fields  $k$ ,  $q$  and  $R$ .

# Index

**Symbols Numbers A B C D E F G H I J K L M N O P Q R S T U V W X Z**

## Symbols

- \*
  - tensor member function, [P-25](#)
- +
  - tensor member function, [P-25](#)
- - tensor member function, [P-25](#)
- /
  - tensor member function, [P-25](#)
- /\*...\*/
  - C++ syntax, [U-78](#)
- //
  - C++ syntax, [U-78](#)
  - OpenFOAM file syntax, [U-102](#)
- # include
  - C++ syntax, [U-72](#), [U-78](#)
- &
  - tensor member function, [P-25](#)
- &&
  - tensor member function, [P-25](#)
- ~
  - tensor member function, [P-25](#)
- <LESmodel>Coeffs keyword, [U-179](#)
- <RASModel>Coeffs keyword, [U-179](#)
- <delta>Coeffs keyword, [U-179](#)
- cellSet utility, [U-90](#)
- faceSet utility, [U-90](#)
- pointSet utility, [U-90](#)
- 0.000000e+00 directory, [U-102](#)
- 1-dimensional mesh, [U-126](#)
- 1D mesh, [U-126](#)
- 2-dimensional mesh, [U-126](#)
- 2D mesh, [U-126](#)
- adjustTimeStep keyword, [U-60](#)
- agglomerator keyword, [U-119](#)
- algorithms tools, [U-94](#)
- alphaContactAngle
  - boundary condition, [U-58](#)
- analytical solution, [P-45](#)
- anisotropicFilter model, [U-98](#)
- Annotation window panel, [U-26](#), [U-163](#)
- ansysToFoam utility, [U-89](#)
- APIfunctions model, [U-97](#)
- applications, [U-69](#)
- Apply button, [U-160](#), [U-164](#)
- applyBoundaryLayer utility, [U-89](#)
- applyWallFunctionBoundaryConditions utility, [U-89](#)
- arbitrarily unstructured, [P-31](#)
- arc
  - keyword entry, [U-136](#)
- arc keyword, [U-135](#)
- ascii
  - keyword entry, [U-109](#)
- attachMesh utility, [U-90](#)
- Auto Accept button, [U-163](#)
- autoMesh
  - library, [U-95](#)
- autoPatch utility, [U-90](#)
- autoRefineMesh utility, [U-91](#)
- axes
  - right-handed, [U-134](#)
  - right-handed rectangular Cartesian, [P-15](#), [U-20](#)
- axi-symmetric cases, [U-131](#), [U-139](#)
- axi-symmetric mesh, [U-126](#)

## Numbers

0 directory, [U-102](#)

## A

- access functions, [P-23](#)
- addLayersControls keyword, [U-142](#)
- adiabaticFlameT utility, [U-93](#)
- adjustableRunTime
  - keyword entry, [U-60](#), [U-109](#)

## B

- background
  - process, [U-26](#), [U-81](#)
- backward
  - keyword entry, [U-116](#)
- Backward differencing, [P-39](#)
- barotropicCompressibilityModels
  - library, [U-97](#)

- basicMultiComponentMixture model, [U-96](#), [U-176](#)
  - basicThermophysicalModels
    - library, [U-96](#)
  - binary
    - keyword entry, [U-109](#)
  - BirdCarreau model, [U-99](#)
  - blended differencing, [P-38](#)
  - block
    - expansion ratio, [U-136](#)
  - block keyword, [U-135](#)
  - blockMesh solver, [P-47](#)
  - blockMesh utility, [U-38](#), [U-89](#), [U-132](#)
  - blockMesh executable
    - vertex numbering, [U-136](#)
  - blockMeshDict*
    - dictionary, [U-20](#), [U-22](#), [U-37](#), [U-49](#), [U-132](#), [U-140](#)
  - blocks keyword, [U-22](#), [U-32](#), [U-136](#)
  - boundaries, [U-128](#)
  - boundary, [U-128](#)
  - boundary*
    - dictionary, [U-125](#), [U-132](#)
  - boundary condition
    - alphaContactAngle, [U-58](#)
    - calculated, [U-132](#)
    - cyclic, [U-131](#)
    - directionMixed, [U-132](#)
    - empty, [P-63](#), [P-69](#), [U-20](#), [U-126](#), [U-131](#)
    - fixedGradient, [U-132](#)
    - fixedValue, [U-132](#)
    - fluxCorrectedVelocity, [U-133](#)
    - inlet, [P-69](#)
    - inletOutlet, [U-133](#)
    - mixed, [U-132](#)
    - movingWallVelocity, [U-133](#)
    - outlet, [P-69](#)
    - outletInlet, [U-133](#)
    - partialSlip, [U-133](#)
    - patch, [U-131](#)
    - pressureDirectedInletVelocity, [U-133](#)
    - pressureInletVelocity, [U-133](#)
    - pressureOutlet, [P-63](#)
    - pressureTransmissive, [U-133](#)
    - processor, [U-131](#)
    - setup, [U-22](#)
    - slip, [U-133](#)
    - supersonicFreeStream, [U-133](#)
    - surfaceNormalFixedValue, [U-133](#)
    - symmetryPlane, [P-63](#), [U-131](#)
    - totalPressure, [U-133](#)
    - turbulentInlet, [U-133](#)
    - wall, [U-41](#)
    - wall, [P-63](#), [P-69](#), [U-58](#), [U-131](#)
    - wallBuoyantPressure, [U-133](#)
    - wedge, [U-126](#), [U-131](#), [U-139](#)
    - zeroGradient, [U-132](#)
  - boundary conditions, [P-43](#)
    - Dirichlet, [P-43](#)
    - inlet, [P-44](#)
    - Neumann, [P-43](#)
    - no-slip impermeable wall, [P-44](#)
    - outlet, [P-44](#)
    - physical, [P-44](#)
    - symmetry plane, [P-44](#)
  - boundaryField keyword, [U-22](#), [U-106](#)
  - boundaryFoam solver, [U-85](#)
  - bounded
    - keyword entry, [U-114](#), [U-115](#)
  - boxToCell keyword, [U-59](#)
  - boxTurb utility, [U-89](#)
  - breaking of a dam, [U-56](#)
  - bubbleFoam solver, [U-86](#)
  - buoyantBoussinesqPisoFoam solver, [U-87](#)
  - buoyantBoussinesqSimpleFoam solver, [U-87](#)
  - buoyantPisoFoam solver, [U-87](#)
  - buoyantSimpleFoam solver, [U-87](#)
  - buoyantSimpleRadiationFoam solver, [U-87](#)
  - button
    - Apply, [U-160](#), [U-164](#)
    - Auto Accept, [U-163](#)
    - Choose Preset, [U-162](#)
    - Delete, [U-160](#)
    - Edit Color Map, [U-161](#)
    - Enable Line Series, [U-36](#)
    - Orientation Axes, [U-26](#), [U-163](#)
    - Rescale to Data Range, [U-28](#)
    - Reset, [U-160](#)
    - Set Solid Color, [U-162](#)
    - Update GUI, [U-28](#), [U-161](#)
    - Use Parallel Projection, [U-25](#)
    - Use parallel projection, [U-163](#)
- ## C
- C++ syntax
    - /\*...\*/, [U-78](#)
    - //, [U-78](#)
    - # include, [U-72](#), [U-78](#)
  - cacheAgglomeration keyword, [U-120](#)
  - calculated
    - boundary condition, [U-132](#)
  - cAlpha keyword, [U-62](#)
  - cases, [U-101](#)
  - castellatedMesh keyword, [U-142](#)
  - castellatedMeshControls*
    - dictionary, [U-143](#), [U-145](#)
  - castellatedMeshControls keyword, [U-142](#)
  - cavitatingFoam solver, [U-86](#)

- cavity flow, [U-19](#)
- CEI\_ARCH
  - environment variable, [U-169](#)
- CEI\_HOME
  - environment variable, [U-169](#)
- cell
  - expansion ratio, [U-136](#)
- cell class, [P-31](#)
- cell
  - keyword entry, [U-170](#)
- cellPoint
  - keyword entry, [U-170](#)
- cellPointFace
  - keyword entry, [U-170](#)
- cells
  - dictionary, [U-132](#)
- central differencing, [P-38](#)
- cfTools tools, [U-95](#)
- cfx4ToFoam utility, [U-89](#), [U-149](#)
- changeDictionary utility, [U-89](#)
- channelFoam solver, [U-85](#)
- Chart Options window, [U-36](#)
- checkMesh utility, [U-90](#), [U-151](#)
- chemistryModel
  - library, [U-97](#)
- chemistryModel model, [U-97](#)
- chemistrySolver model, [U-97](#)
- chemkinToFoam utility, [U-93](#)
- Choose Preset button, [U-162](#)
- chtMultiRegionFoam solver, [U-87](#)
- Chung
  - library, [U-97](#)
- class
  - cell, [P-31](#)
  - dimensionSet, [P-25](#), [P-32](#), [P-33](#)
  - face, [P-31](#)
  - finiteVolumeCalculus, [P-33](#)
  - finiteVolumeMethod, [P-33](#)
  - fvMesh, [P-31](#)
  - fvSchemes, [P-36](#)
  - fvc, [P-36](#)
  - fvm, [P-36](#)
  - pointField, [P-31](#)
  - polyBoundaryMesh, [P-31](#)
  - polyMesh, [P-31](#), [U-123](#), [U-125](#)
  - polyPatchList, [P-31](#)
  - polyPatch, [P-31](#)
  - scalarField, [P-29](#)
  - scalar, [P-23](#)
  - slice, [P-31](#)
  - symmTensorField, [P-29](#)
  - symmTensorThirdField, [P-29](#)
  - tensorField, [P-29](#)
  - tensorThirdField, [P-29](#)
  - tensor, [P-23](#)
  - vectorField, [P-29](#)
  - vector, [P-23](#), [U-105](#)
  - word, [P-25](#), [P-31](#)
- class keyword, [U-103](#)
- clockTime
  - keyword entry, [U-109](#)
- cloud keyword, [U-171](#)
- cmptAv
  - tensor member function, [P-25](#)
- Co utility, [U-91](#)
- coalChemistryFoam solver, [U-88](#)
- coalCombustion
  - library, [U-95](#)
- cofactors
  - tensor member function, [P-25](#)
- coldEngineFoam solver, [U-87](#)
- collapseEdges utility, [U-91](#)
- Color By menu, [U-162](#)
- Color Legend window, [U-30](#)
- Color Legend window panel, [U-162](#)
- Color Scale window panel, [U-162](#)
- combinePatchFaces utility, [U-91](#)
- comments, [U-78](#)
- compressed
  - keyword entry, [U-109](#)
- compressibleInterDyMFoam solver, [U-86](#)
- compressibleInterFoam solver, [U-86](#)
- compressibleLESModels
  - library, [U-99](#)
- compressibleRASModels
  - library, [U-98](#)
- constant* directory, [U-102](#), [U-175](#)
- constLaminarFlameSpeed model, [U-97](#)
- constTransport model, [U-97](#), [U-176](#)
- containers tools, [U-94](#)
- continuum
  - mechanics, [P-15](#)
- control
  - of time, [U-108](#)
- controlDict*
  - dictionary, [P-65](#), [U-23](#), [U-32](#), [U-42](#), [U-51](#), [U-60](#), [U-102](#), [U-155](#)
- controlDict* file, [P-49](#)
- convection, *see* divergence, [P-38](#)
- convergence, [U-40](#)
- conversion
  - library, [U-96](#)
- convertToMeters keyword, [U-134](#), [U-135](#)
- coordinate
  - system, [P-15](#)
- coordinate system, [U-20](#)
- corrected
  - keyword entry, [U-114](#), [U-115](#)

- Courant number, [P-42](#), [U-24](#)
- cpuTime  
keyword entry, [U-109](#)
- Crank Nicholson  
temporal discretisation, [P-42](#)
- CrankNicholson  
keyword entry, [U-116](#)
- createBaffles utility, [U-90](#)
- createPatch utility, [U-90](#)
- createTurbulenceFields utility, [U-92](#)
- cross product, *see* tensor, vector cross product
- CrossPowerLaw  
keyword entry, [U-59](#)
- CrossPowerLaw model, [U-99](#)
- cubeRootVolDelta model, [U-98](#)
- cubicCorrected  
keyword entry, [U-116](#)
- cubicCorrection  
keyword entry, [U-113](#)
- curl, [P-37](#)
- curl  
fvc member function, [P-37](#)
- Current Time Controls menu, [U-28](#), [U-161](#)
- curve keyword, [U-171](#)
- cyclic  
boundary condition, [U-131](#)
- cyclic  
keyword entry, [U-130](#)
- cylinder  
flow around a, [P-45](#)
- ## D
- d2dt2  
fvc member function, [P-37](#)  
fvm member function, [P-37](#)
- dam  
breaking of a, [U-56](#)
- db tools, [U-94](#)
- ddt  
fvc member function, [P-37](#)  
fvm member function, [P-37](#)
- DeardorffDiffStress model, [U-99](#)
- debug keyword, [U-142](#)
- decomposePar utility, [U-81](#), [U-82](#), [U-93](#)
- decomposeParDict*  
dictionary, [U-81](#)
- decomposition  
of field, [U-81](#)  
of mesh, [U-81](#)
- decompositionMethods  
library, [U-96](#)
- decompression of a tank, [P-62](#)
- defaultFieldValues keyword, [U-59](#)
- deformedGeom utility, [U-90](#)
- Delete button, [U-160](#)
- delta keyword, [U-83](#), [U-179](#)
- deltaT keyword, [U-108](#)
- dependencies, [U-72](#)
- dependency lists, [U-72](#)
- det  
tensor member function, [P-25](#)
- determinant, *see* tensor, determinant
- dev  
tensor member function, [P-25](#)
- diag  
tensor member function, [P-25](#)
- diagonal  
keyword entry, [U-119](#)
- DIC  
keyword entry, [U-119](#)
- DICGaussSeidel  
keyword entry, [U-119](#)
- dictionary  
*LESProperties*, [U-179](#)  
*PISO*, [U-25](#)  
*blockMeshDict*, [U-20](#), [U-22](#), [U-37](#), [U-49](#),  
[U-132](#), [U-140](#)  
*boundary*, [U-125](#), [U-132](#)  
*castellatedMeshControls*, [U-143](#), [U-145](#)  
*cells*, [U-132](#)  
*controlDict*, [P-65](#), [U-23](#), [U-32](#), [U-42](#), [U-51](#),  
[U-60](#), [U-102](#), [U-155](#)  
*decomposeParDict*, [U-81](#)  
*faces*, [U-125](#), [U-132](#)  
*fvSchemes*, [U-61](#), [U-102](#), [U-110](#), [U-111](#)  
*fvSolution*, [U-102](#), [U-117](#)  
*mechanicalProperties*, [U-51](#)  
*neighbour*, [U-125](#)  
*owner*, [U-125](#)  
*points*, [U-125](#), [U-132](#)  
*thermalProperties*, [U-51](#)  
*thermophysicalProperties*, [U-175](#)  
*transportProperties*, [U-23](#), [U-39](#), [U-42](#)  
*turbulenceProperties*, [U-42](#), [U-60](#), [U-178](#)
- dieselEngineFoam solver, [U-87](#)
- dieselFoam solver, [U-87](#)
- dieselMixture model, [U-96](#), [U-176](#)
- dieselSpray  
library, [U-95](#)
- differencing  
Backward, [P-39](#)  
blended, [P-38](#)  
central, [P-38](#)  
Euler implicit, [P-39](#)  
Gamma, [P-38](#)  
MINMOD, [P-38](#)  
SUPERBEE, [P-38](#)  
upwind, [P-38](#)



- van Leer, [P-38](#)
  - DILU
    - keyword entry, [U-119](#)
  - dimension
    - checking in OpenFOAM, [P-25](#), [U-105](#)
  - dimensional units, [U-105](#)
  - dimensioned<Type> template class, [P-25](#)
  - dimensionedTypes tools, [U-94](#)
  - dimensions keyword, [U-22](#), [U-106](#)
  - dimensionSet class, [P-25](#), [P-32](#), [P-33](#)
  - dimensionSet tools, [U-94](#)
  - direct numerical simulation, [U-61](#)
  - directionMixed
    - boundary condition, [U-132](#)
  - directory
    - 0.000000e+00*, [U-102](#)
    - 0*, [U-102](#)
    - Make*, [U-73](#)
    - constant*, [U-102](#), [U-175](#)
    - fluentInterface*, [U-166](#)
    - polyMesh*, [U-102](#), [U-125](#)
    - processorN*, [U-82](#)
    - run*, [U-101](#)
    - system*, [P-49](#), [U-102](#)
    - tutorials*, [P-45](#), [U-19](#)
  - discretisation
    - equation, [P-33](#)
  - Display window panel, [U-25](#), [U-28](#), [U-160](#), [U-161](#)
  - distance
    - keyword entry, [U-145](#), [U-171](#)
  - distributed keyword, [U-83](#), [U-84](#)
  - div
    - fvc member function, [P-37](#)
    - fvm member function, [P-37](#)
  - divergence, [P-37](#), [P-39](#)
  - divSchemes keyword, [U-111](#)
  - dnsFoam solver, [U-87](#)
  - doLayers keyword, [U-142](#)
  - double inner product, *see* tensor,double inner product
  - dsmc
    - library, [U-95](#)
  - dsmcFieldsCalc utility, [U-93](#)
  - dsmcFoam solver, [U-88](#)
  - dsmcInitialise utility, [U-89](#)
  - dx
    - keyword entry, [U-170](#)
  - dynamicFvMesh
    - library, [U-95](#)
  - dynamicMesh
    - library, [U-95](#)
  - dynMixedSmagorinsky model, [U-99](#)
  - dynOneEqEddy model, [U-99](#)
  - dynSmagorinsky model, [U-99](#)
- ## E
- eConstThermo model, [U-97](#), [U-175](#)
  - edgeGrading keyword, [U-137](#)
  - edgeMesh
    - library, [U-95](#)
  - edges keyword, [U-135](#)
  - Edit menu, [U-163](#)
  - Edit Color Map button, [U-161](#)
  - egrMixture model, [U-96](#), [U-176](#)
  - electrostaticFoam solver, [U-88](#)
  - empty
    - boundary condition, [P-63](#), [P-69](#), [U-20](#), [U-126](#), [U-131](#)
  - empty
    - keyword entry, [U-130](#)
  - Enable Line Series button, [U-36](#)
  - endTime keyword, [U-24](#), [U-108](#)
  - engine
    - library, [U-96](#)
  - engineCompRatio utility, [U-93](#)
  - engineFoam solver, [U-87](#)
  - engineSwirl utility, [U-89](#)
  - ensight74FoamExec utility, [U-168](#)
  - ENSIGHT7\_INPUT
    - environment variable, [U-169](#)
  - ENSIGHT7\_READER
    - environment variable, [U-169](#)
  - ensightFoamReader utility, [U-91](#)
  - enstrophy utility, [U-91](#)
  - environment variable
    - CEI\_ARCH, [U-169](#)
    - CEI\_HOME, [U-169](#)
    - ENSIGHT7\_INPUT, [U-169](#)
    - ENSIGHT7\_READER, [U-169](#)
    - FOAM\_RUN, [U-101](#)
    - WM\_ARCH, [U-76](#)
    - WM\_COMPILER\_BIN, [U-76](#)
    - WM\_COMPILER\_DIR, [U-76](#)
    - WM\_COMPILER\_LIB, [U-76](#)
    - WM\_COMPILER, [U-76](#)
    - WM\_COMPILE\_OPTION, [U-76](#)
    - WM\_DIR, [U-76](#)
    - WM\_JAVAC\_OPTION, [U-76](#)
    - WM\_LINK\_LANGUAGE, [U-76](#)
    - WM\_MPLIB, [U-76](#)
    - WM\_OPTIONS, [U-76](#)
    - WM\_PROJECT\_DIR, [U-76](#)
    - WM\_PROJECT\_INST\_DIR, [U-76](#)
    - WM\_PROJECT\_LANGUAGE, [U-76](#)
    - WM\_PROJECT\_USER\_DIR, [U-76](#)
    - WM\_PROJECT\_VERSION, [U-76](#)
    - WM\_PROJECT, [U-76](#)

- WM.SHELL, [U-76](#)
  - wmake, [U-75](#)
  - ePsiThermo model, [U-96](#), [U-176](#)
  - equilibriumCO utility, [U-93](#)
  - equilibriumFlameT utility, [U-93](#)
  - errorEstimation
    - library, [U-95](#)
  - errorReduction keyword, [U-149](#)
  - estimateScalarError utility, [U-93](#)
  - Euler
    - keyword entry, [U-116](#)
  - Euler implicit
    - differencing, [P-39](#)
    - temporal discretisation, [P-42](#)
  - examples
    - decompression of a tank, [P-62](#)
    - flow around a cylinder, [P-45](#)
    - flow over backward step, [P-53](#)
    - Hartmann problem, [P-67](#)
    - supersonic flow over forward step, [P-58](#)
  - execFlowFunctionObjects utility, [U-93](#)
  - expandDictionary utility, [U-94](#)
  - expansionRatio keyword, [U-148](#)
  - explicit
    - temporal discretisation, [P-42](#)
  - exponential model, [U-97](#)
  - extrude2DMesh utility, [U-89](#)
  - extrudeMesh utility, [U-89](#)
- F**
- face class, [P-31](#)
  - face keyword, [U-171](#)
  - faceAreaPair
    - keyword entry, [U-119](#)
  - faces
    - dictionary, [U-125](#), [U-132](#)
  - FDIC
    - keyword entry, [U-119](#)
  - featureAngle keyword, [U-148](#)
  - features keyword, [U-143](#)
  - field
    - U, [U-24](#)
    - p, [U-24](#)
    - decomposition, [U-81](#)
  - FieldField<Type> template class, [P-32](#)
  - fieldFunctionObjects
    - library, [U-95](#)
  - fields, [P-29](#)
    - mapping, [U-155](#)
  - fields tools, [U-94](#), [U-95](#)
  - fields keyword, [U-170](#)
  - Field<Type> template class, [P-29](#)
  - fieldValues keyword, [U-59](#)
  - fieldview9Reader utility, [U-91](#)
  - file
    - Make/files, [U-74](#)
    - controlDict, [P-49](#)
    - files, [U-73](#)
    - g, [U-59](#)
    - options, [U-73](#)
    - snappyHexMeshDict, [U-141](#)
    - transportProperties, [U-59](#)
  - file format, [U-102](#)
  - files file, [U-73](#)
  - finalLayerRatio keyword, [U-148](#)
  - financialFoam solver, [U-88](#)
  - finite volume
    - discretisation, [P-27](#)
    - mesh, [P-31](#)
  - finiteVolume
    - library, [U-95](#)
  - finiteVolume tools, [U-95](#)
  - finiteVolumeCalculus class, [P-33](#)
  - finiteVolumeMethod class, [P-33](#)
  - firstTime keyword, [U-108](#)
  - fixed
    - keyword entry, [U-109](#)
  - fixedGradient
    - boundary condition, [U-132](#)
  - fixedValue
    - boundary condition, [U-132](#)
  - flattenMesh utility, [U-90](#)
  - flow
    - free surface, [U-56](#)
    - laminar, [U-19](#)
    - steady, turbulent, [P-53](#)
    - supersonic, [P-58](#)
    - turbulent, [U-19](#)
  - flow around a cylinder, [P-45](#)
  - flow over backward step, [P-53](#)
  - flowType utility, [U-91](#)
  - fluent3DMeshToFoam utility, [U-89](#)
  - fluentInterface directory, [U-166](#)
  - fluentMeshToFoam utility, [U-89](#), [U-149](#)
  - fluxCorrectedVelocity
    - boundary condition, [U-133](#)
  - fluxRequired keyword, [U-111](#)
  - OpenFOAM
    - cases, [U-101](#)
  - FOAM.RUN
    - environment variable, [U-101](#)
  - foamCalc utility, [U-34](#)
  - foamCalcFunctions
    - library, [U-95](#)
  - foamCorrectVrt script/alias, [U-154](#)
  - foamDataToFluent utility, [U-91](#), [U-166](#)
  - foamDebugSwitches utility, [U-94](#)
  - FoamFile keyword, [U-103](#)

foamFile  
 keyword entry, [U-170](#)  
 foamFormatConvert utility, [U-94](#)  
 foamInfoExec utility, [U-94](#)  
 foamJob script/alias, [U-173](#)  
 foamLog script/alias, [U-173](#)  
 foamMeshToFluent utility, [U-89](#), [U-166](#)  
 foamToEnight utility, [U-91](#)  
 foamToEnightParts utility, [U-91](#)  
 foamToFieldview9 utility, [U-91](#)  
 foamToGMV utility, [U-91](#)  
 foamToStarMesh utility, [U-89](#)  
 foamToVTK utility, [U-91](#)  
 foamUpgradeFvSolution utility, [U-89](#)  
 forces  
 library, [U-95](#)  
 foreground  
 process, [U-26](#)  
 format keyword, [U-103](#)  
 fourth  
 keyword entry, [U-114](#), [U-115](#)  
 functions keyword, [U-110](#)  
 fvc class, [P-36](#)  
 fvc member function  
 curl, [P-37](#)  
 d2dt2, [P-37](#)  
 ddt, [P-37](#)  
 div, [P-37](#)  
 gGrad, [P-37](#)  
 grad, [P-37](#)  
 laplacian, [P-37](#)  
 lsGrad, [P-37](#)  
 snGrad, [P-37](#)  
 snGradCorrection, [P-37](#)  
 sqrGradGrad, [P-37](#)  
 fvDOM  
 library, [U-96](#)  
 fvm class, [P-36](#)  
 fvm member function  
 d2dt2, [P-37](#)  
 ddt, [P-37](#)  
 div, [P-37](#)  
 laplacian, [P-37](#)  
 Su, [P-37](#)  
 SuSp, [P-37](#)  
 fvMatrices tools, [U-95](#)  
 fvMatrix template class, [P-33](#)  
 fvMesh class, [P-31](#)  
 fvMesh tools, [U-95](#)  
 fvMotionSolver  
 library, [U-95](#)  
 fvSchemes  
 dictionary, [U-61](#), [U-102](#), [U-110](#), [U-111](#)  
 fvSchemes class, [P-36](#)

fvSchemes  
 menu entry, [U-52](#)  
 fvSolution  
 dictionary, [U-102](#), [U-117](#)  

## G

 g file, [U-59](#)  
 gambitToFoam utility, [U-89](#), [U-149](#)  
 GAMG  
 keyword entry, [U-53](#), [U-118](#), [U-119](#)  
 Gamma  
 keyword entry, [U-113](#)  
 Gamma differencing, [P-38](#)  
 Gauss  
 keyword entry, [U-114](#)  
 Gauss's theorem, [P-36](#)  
 GaussSeidel  
 keyword entry, [U-119](#)  
 General window panel, [U-163](#)  
 general model, [U-97](#)  
 general  
 keyword entry, [U-109](#)  
 geometric-algebraic multi-grid, [U-119](#)  
 GeometricBoundaryField template class, [P-32](#)  
 geometricField<Type> template class, [P-32](#)  
 geometry keyword, [U-142](#)  
 gGrad  
 fvc member function, [P-37](#)  
 global tools, [U-94](#)  
 gmshToFoam utility, [U-89](#)  
 gnuplot  
 keyword entry, [U-109](#), [U-170](#)  
 grad  
 fvc member function, [P-37](#)  
 (Grad Grad) squared, [P-37](#)  
 gradient, [P-37](#), [P-40](#)  
 Gauss scheme, [P-40](#)  
 Gauss's theorem, [U-52](#)  
 least square fit, [U-52](#)  
 least squares method, [P-40](#), [U-52](#)  
 surface normal, [P-40](#)  
 gradSchemes keyword, [U-111](#)  
 graph tools, [U-94](#)  
 graphFormat keyword, [U-109](#)  
 GuldersonEGR Laminar Flame Speed model, [U-97](#)  
 Gulderson Laminar Flame Speed model, [U-97](#)

## H

hConstThermo model, [U-97](#), [U-175](#)  
 Help menu, [U-163](#)  
 HerschelBulkley model, [U-99](#)  
 hhuMixtu e 2349 cm BT R27 1 9 91 Tf 1 1 299 9 7 1

homogeneousMixture model, [U-96](#), [U-176](#)  
 hPolynomialThermo model, [U-97](#), [U-175](#)  
 hPsiMixtureThermo model, [U-96](#), [U-176](#)  
 hPsiThermo model, [U-96](#), [U-176](#)  
 hRhoMixtureThermo model, [U-96](#), [U-176](#)  
 hRhoThermo model, [U-96](#), [U-176](#)

## I

I  
 tensor member function, [P-25](#)  
 icoErrorEstimate utility, [U-93](#)  
 icoFoam solver, [U-19](#), [U-23](#), [U-24](#), [U-26](#), [U-85](#)  
 icoMomentError utility, [U-94](#)  
 icoPolynomial model, [U-97](#), [U-175](#)  
 ideasToFoam utility, [U-149](#)  
 ideasUnvToFoam utility, [U-89](#)  
 identities, *see* tensor, identities  
 identity, *see* tensor, identity  
 incompressibleLESModels  
 library, [U-99](#)  
 incompressibleRASModels  
 library, [U-98](#)  
 incompressibleTransportModels  
 library, [P-55](#), [U-99](#)  
 incompressibleTurbulenceModels  
 library, [P-55](#)  
 index  
 notation, [P-16](#), [P-17](#)  
 Information window panel, [U-160](#)  
 inhomogeneousMixture model, [U-96](#), [U-176](#)  
 inlet  
 boundary condition, [P-69](#)  
 inletOutlet  
 boundary condition, [U-133](#)  
 inner product, *see* tensor, inner product  
 inside  
 keyword entry, [U-145](#)  
 insideCells utility, [U-90](#)  
 interDyMFoam solver, [U-86](#)  
 interfaceProperties model, [U-99](#)  
 interFoam solver, [U-87](#)  
 internalField keyword, [U-22](#), [U-106](#)  
 interPhaseChangeFoam solver, [U-87](#)  
 interpolation tools, [U-95](#)  
 interpolationScheme keyword, [U-170](#)  
 interpolations tools, [U-94](#)  
 interpolationSchemes keyword, [U-111](#)  
 inv  
 tensor member function, [P-25](#)

## J

janafThermo model, [U-97](#), [U-175](#)  
 jplot  
 keyword entry, [U-109](#), [U-170](#)

## K

kEpsilon model, [U-98](#)  
 keyword  
 FoamFile, [U-103](#)  
 LESmodel, [U-179](#)  
 RASModel, [U-179](#)  
 addLayersControls, [U-142](#)  
 adjustTimeStep, [U-60](#)  
 agglomerator, [U-119](#)  
 arc, [U-135](#)  
 blocks, [U-22](#), [U-32](#), [U-136](#)  
 block, [U-135](#)  
 boundaryField, [U-22](#), [U-106](#)  
 boxToCell, [U-59](#)  
 cAlpha, [U-62](#)  
 cacheAgglomeration, [U-120](#)  
 castellatedMeshControls, [U-142](#)  
 castellatedMesh, [U-142](#)  
 class, [U-103](#)  
 cloud, [U-171](#)  
 convertToMeters, [U-134](#), [U-135](#)  
 curve, [U-171](#)  
 debug, [U-142](#)  
 defaultFieldValues, [U-59](#)  
 deltaT, [U-108](#)  
 delta, [U-83](#), [U-179](#)  
 dimensions, [U-22](#), [U-106](#)  
 distributed, [U-83](#), [U-84](#)  
 divSchemes, [U-111](#)  
 doLayers, [U-142](#)  
 edgeGrading, [U-137](#)  
 edges, [U-135](#)  
 endTime, [U-24](#), [U-108](#)  
 errorReduction, [U-149](#)  
 expansionRatio, [U-148](#)  
 face, [U-171](#)  
 featureAngle, [U-148](#)  
 features, [U-143](#)  
 fieldValues, [U-59](#)  
 fields, [U-170](#)  
 finalLayerRatio, [U-148](#)  
 firstTime, [U-108](#)  
 fluxRequired, [U-111](#)  
 format, [U-103](#)  
 functions, [U-110](#)  
 geometry, [U-142](#)  
 gradSchemes, [U-111](#)  
 graphFormat, [U-109](#)  
 internalField, [U-22](#), [U-106](#)  
 interpolationSchemes, [U-111](#)  
 interpolationScheme, [U-170](#)  
 laplacianSchemes, [U-111](#)  
 latestTime, [U-39](#)  
 layers, [U-148](#)

---

leastSquares, [U-52](#)  
levels, [U-146](#)  
libs, [U-80](#), [U-110](#)  
locationInMesh, [U-143](#), [U-145](#)  
location, [U-103](#)  
manualCoeffs, [U-83](#)  
maxBoundarySkewness, [U-149](#)  
maxConcave, [U-149](#)  
maxCo, [U-60](#)  
maxDeltaT, [U-60](#)  
maxFaceThicknessRatio, [U-148](#)  
maxGlobalCells, [U-143](#)  
maxInternalSkewness, [U-149](#)  
maxLocalCells, [U-143](#)  
maxNonOrtho, [U-149](#)  
maxThicknessToMedialRatio, [U-148](#)  
mergeLevels, [U-120](#)  
mergePatchPairs, [U-135](#)  
mergeTolerance, [U-142](#)  
meshQualityControls, [U-142](#)  
method, [U-83](#)  
metisCoeffs, [U-83](#)  
midPointAndFace, [U-171](#)  
midPoint, [U-171](#)  
minArea, [U-149](#)  
minDeterminant, [U-149](#)  
minFaceWeight, [U-149](#)  
minFlatness, [U-149](#)  
minMedianAxisAngle, [U-148](#)  
minRefinementCells, [U-143](#)  
minThickness, [U-148](#)  
minTriangleTwist, [U-149](#)  
minTwist, [U-149](#)  
minVolRatio,

- uniform, [U-171](#)
- valueFraction, [U-132](#)
- value, [U-23](#), [U-132](#)
- version, [U-103](#)
- vertices, [U-22](#), [U-135](#)
- writeCompression, [U-109](#)
- writeControl, [U-24](#), [U-60](#), [U-108](#)
- writeFormat, [U-55](#), [U-109](#)
- writeInterval, [U-24](#), [U-33](#), [U-109](#)
- writePrecision, [U-109](#)
- <LESmodel>Coeffs, [U-179](#)
- <RASModel>Coeffs, [U-179](#)
- <delta>Coeffs, [U-179](#)
- keyword entry
  - CrankNicholson, [U-116](#)
  - CrossPowerLaw, [U-59](#)
  - DICGaussSeidel, [U-119](#)
  - DIC, [U-119](#)
  - DILU, [U-119](#)
  - Euler, [U-116](#)
  - FDIC, [U-119](#)
  - GAMG, [U-53](#), [U-118](#), [U-119](#)
  - Gamma, [U-113](#)
  - GaussSeidel, [U-119](#)
  - Gauss, [U-114](#)
  - LESmodel, [U-42](#), [U-178](#)
  - MGridGen, [U-119](#)
  - MUSCL, [U-113](#)
  - Newtonian, [U-59](#)
  - PBiCG, [U-118](#)
  - PCG, [U-118](#)
  - QUICK, [U-113](#), [U-116](#)
  - RASmodel, [U-42](#), [U-178](#)
  - SFCD, [U-113](#), [U-116](#)
  - UMIST, [U-112](#)
  - adjustableRunTime, [U-60](#), [U-109](#)
  - arc, [U-136](#)
  - ascii, [U-109](#)
  - backward, [U-116](#)
  - binary, [U-109](#)
  - bounded, [U-114](#), [U-115](#)
  - cellPointFace, [U-170](#)
  - cellPoint, [U-170](#)
  - cell, [U-170](#)
  - clockTime, [U-109](#)
  - compressed, [U-109](#)
  - corrected, [U-114](#), [U-115](#)
  - cpuTime, [U-109](#)
  - cubicCorrected, [U-116](#)
  - cubicCorrection, [U-113](#)
  - cyclic, [U-130](#)
  - diagonal, [U-119](#)
  - distance, [U-145](#), [U-171](#)
  - dx, [U-170](#)
  - empty, [U-130](#)
  - faceAreaPair, [U-119](#)
  - fixed, [U-109](#)
  - foamFile, [U-170](#)
  - fourth, [U-114](#), [U-115](#)
  - general, [U-109](#)
  - gnuplot, [U-109](#), [U-170](#)
  - hierarchical, [U-82](#), [U-83](#)
  - inside, [U-145](#)
  - jplot, [U-109](#), [U-170](#)
  - laminar, [U-42](#), [U-178](#)
  - latestTime, [U-108](#)
  - leastSquares, [U-114](#)
  - limitedCubic, [U-113](#)
  - limitedLinear, [U-113](#)
  - limited, [U-114](#), [U-115](#)
  - linearUpwind, [U-113](#), [U-116](#)
  - linear, [U-113](#), [U-116](#)
  - line, [U-136](#)
  - manual, [U-82](#), [U-83](#)
  - metis, [U-82](#), [U-83](#)
  - midPoint, [U-113](#)
  - nextWrite, [U-108](#)
  - noWriteNow, [U-108](#)
  - none, [U-112](#), [U-119](#)
  - null, [U-170](#)
  - outside, [U-145](#)
  - patch, [U-130](#), [U-172](#)
  - polyLine, [U-136](#)
  - polySpline, [U-136](#)
  - processor, [U-130](#)
  - raw, [U-109](#), [U-170](#)
  - runTime, [U-33](#), [U-108](#)
  - scientific, [U-109](#)
  - scotch, [U-82](#), [U-83](#)
  - simpleSpline, [U-136](#)
  - simple, [U-82](#), [U-83](#)
  - skewLinear, [U-113](#), [U-116](#)
  - smoothSolver, [U-118](#)
  - startTime, [U-23](#), [U-108](#)
  - steadyState, [U-116](#)
  - stl, [U-170](#)
  - symmetryPlane, [U-130](#)
  - timeStep, [U-24](#), [U-33](#), [U-108](#)
  - uncompressed, [U-109](#)
  - uncorrected, [U-114](#), [U-115](#)
  - upwind, [U-113](#), [U-116](#)
  - vanLeer, [U-113](#)
  - vtk, [U-170](#)
  - wall, [U-130](#)
  - wedge, [U-130](#)
  - writeControl, [U-108](#)
  - writeNow, [U-108](#)
  - xmgr, [U-109](#), [U-170](#)

- xyz, [U-171](#)
  - x, [U-171](#)
  - y, [U-171](#)
  - z, [U-171](#)
  - kivaToFoam utility, [U-89](#)
  - kOmega model, [U-98](#)
  - kOmegaSST model, [U-98](#), [U-99](#)
  - Kronecker delta, [P-20](#)
- ## L
- lagrangian
    - library, [U-95](#)
  - lagrangianIntermediate
    - library, [U-95](#)
  - Lambda2 utility, [U-91](#)
  - LamBremhorstKE model, [U-98](#)
  - laminar model, [U-98](#)
  - laminar
    - keyword entry, [U-42](#), [U-178](#)
  - laminarFlameSpeedModels
    - library, [U-97](#)
  - laplaceFilter model, [U-98](#)
  - Laplacian, [P-38](#)
  - laplacian, [P-37](#)
  - laplacian
    - fvc member function, [P-37](#)
    - fvm member function, [P-37](#)
  - laplacianFoam solver, [U-85](#)
  - laplacianSchemes keyword, [U-111](#)
  - latestTime
    - keyword entry, [U-108](#)
  - latestTime keyword, [U-39](#)
  - LaunderGibsonRSTM model, [U-98](#)
  - LaunderSharmaKE model, [U-98](#)
  - layers keyword, [U-148](#)
  - leastSquares
    - keyword entry, [U-114](#)
  - leastSquares keyword, [U-52](#)
  - LESdeltas
    - library, [U-98](#)
  - LESfilters
    - library, [U-98](#)
  - LESmodel
    - keyword entry, [U-42](#), [U-178](#)
  - LESmodel keyword, [U-179](#)
  - LESProperties*
    - dictionary, [U-179](#)
  - levels keyword, [U-146](#)
  - libraries, [U-69](#)
  - library
    - Chung, [U-97](#)
    - LESdeltas, [U-98](#)
    - LESfilters, [U-98](#)
    - MGridGenGAMGAgglomeration, [U-96](#)
    - ODE, [U-95](#)
    - OSspecific, [U-96](#)
    - OpenFOAM, [U-94](#)
    - P1, [U-96](#)
    - PV3FoamReader, [U-159](#)
    - PVFoamReader, [U-159](#)
    - Wallis, [U-97](#)
    - autoMesh, [U-95](#)
    - barotropicCompressibilityModels, [U-97](#)
    - basicThermophysicalModels, [U-96](#)
    - chemistryModel, [U-97](#)
    - coalCombustion, [U-95](#)
    - compressibleLESModels, [U-99](#)
    - compressibleRASModels, [U-98](#)
    - conversion, [U-96](#)
    - decompositionMethods, [U-96](#)
    - dieselSpray, [U-95](#)
    - dsmc, [U-95](#)
    - dynamicFvMesh, [U-95](#)
    - dynamicMesh, [U-95](#)
    - edgeMesh, [U-95](#)
    - engine, [U-96](#)
    - errorEstimation, [U-95](#)
    - fieldFunctionObjects, [U-95](#)
    - finiteVolume, [U-95](#)
    - foamCalcFunctions, [U-95](#)
    - forces, [U-95](#)
    - fvDOM, [U-96](#)
    - fvMotionSolver, [U-95](#)
    - incompressibleLESModels, [U-99](#)
    - incompressibleRASModels, [U-98](#)
    - incompressibleTransportModels, [P-55](#), [U-99](#)
    - incompressibleTurbulenceModels, [P-55](#)
    - lagrangianIntermediate, [U-95](#)
    - lagrangian, [U-95](#)
    - laminarFlameSpeedModels, [U-97](#)
    - linear, [U-97](#)
    - liquidMixture, [U-98](#)
    - liquids, [U-98](#)
    - meshTools, [U-95](#)
    - molecularMeasurements, [U-95](#)
    - molecule, [U-95](#)
    - pdf, [U-97](#)
    - postCalc, [U-95](#)
    - potential, [U-95](#)
    - primitive, [P-23](#)
    - radiation, [U-96](#)
    - randomProcesses, [U-96](#)
    - reactionThermophysicalModels, [U-96](#)
    - sampling, [U-95](#)
    - solidMixture, [U-98](#)
    - solidParticle, [U-96](#)
    - solids, [U-98](#)
    - specie, [U-97](#)



- surfMesh, [U-95](#)
  - systemCall, [U-95](#)
  - thermophysicalFunctions, [U-97](#)
  - thermophysical, [U-175](#)
  - topoChangerFvMesh, [U-95](#)
  - triSurface, [U-95](#)
  - utilityFunctionObjects, [U-95](#)
  - vtkFoam, [U-159](#)
  - vtkPV3Foam, [U-159](#)
  - libs keyword, [U-80](#), [U-110](#)
  - lid-driven cavity flow, [U-19](#)
  - LienCubicKE model, [U-98](#)
  - LienCubicKELowRe model, [U-98](#)
  - LienLeschzinerLowRe model, [U-98](#)
  - Lights window panel, [U-163](#)
  - limited
    - keyword entry, [U-114](#), [U-115](#)
  - limitedCubic
    - keyword entry, [U-113](#)
  - limitedLinear
    - keyword entry, [U-113](#)
  - line
    - keyword entry, [U-136](#)
  - Line Style menu, [U-36](#)
  - linear
    - library, [U-97](#)
  - linear
    - keyword entry, [U-113](#), [U-116](#)
  - linearUpwind
    - keyword entry, [U-113](#), [U-116](#)
  - liquid
    - electrically-conducting, [P-67](#)
  - liquidMixture
    - library, [U-98](#)
  - liquids
    - library, [U-98](#)
  - lists, [P-29](#)
  - List<Type> template class, [P-29](#)
  - location keyword, [U-103](#)
  - locationInMesh keyword, [U-143](#), [U-145](#)
  - locDynOneEqEddy model, [U-99](#)
  - lowReOneEqEddy model, [U-99](#)
  - LRDDiffStress model, [U-99](#)
  - LRR model, [U-98](#)
  - lsGrad
    - fvc member function, [P-37](#)
- M**
- Mach utility, [U-92](#)
  - mag
    - tensor member function, [P-25](#)
  - magnetohydrodynamics, [P-67](#)
  - magSqr
    - tensor member function, [P-25](#)
  - Make directory, [U-73](#)
  - make script/alias, [U-71](#)
  - Make/files file, [U-74](#)
  - manual
    - keyword entry, [U-82](#), [U-83](#)
  - manualCoeffs keyword, [U-83](#)
  - mapFields utility, [U-32](#), [U-39](#), [U-43](#), [U-55](#), [U-89](#), [U-155](#)
  - mapping
    - fields, [U-155](#)
  - Marker Style menu, [U-36](#)
  - matrices tools, [U-94](#)
  - max
    - tensor member function, [P-25](#)
  - maxBoundarySkewness keyword, [U-149](#)
  - maxCo keyword, [U-60](#)
  - maxConcave keyword, [U-149](#)
  - maxDeltaT keyword, [U-60](#)
  - maxFaceThicknessRatio keyword, [U-148](#)
  - maxGlobalCells keyword, [U-143](#)
  - maxInternalSkewness keyword, [U-149](#)
  - maxLocalCells keyword, [U-143](#)
  - maxNonOrtho keyword, [U-149](#)
  - maxThicknessToMedialRatio keyword, [U-148](#)
  - mdEquilibrationFoam solver, [U-88](#)
  - mdFoam solver, [U-88](#)
  - mdInitialise utility, [U-89](#)
  - mechanicalProperties*
    - dictionary, [U-51](#)
  - memory tools, [U-94](#)
  - menu
    - Color By, [U-162](#)
    - Current Time Controls, [U-28](#), [U-161](#)
    - Edit, [U-163](#)
    - Help, [U-163](#)
    - Line Style, [U-36](#)
    - Marker Style, [U-36](#)
    - Plot Type, [U-35](#)
    - VCR Controls, [U-28](#), [U-161](#)
    - View, [U-163](#)
  - menu entry
    - Plot Over Line, [U-35](#)
    - Save Animation, [U-165](#)
    - Save Screenshot, [U-165](#)
    - Settings, [U-163](#)
    - Show Color Legend, [U-28](#)
    - Solid Color, [U-162](#)
    - Toolbars, [U-163](#)
    - View Settings..., [U-25](#)
    - View Settings, [U-26](#), [U-163](#)
    - Wireframe, [U-162](#)
    - fvSchemes, [U-52](#)
  - mergeLevels keyword, [U-120](#)
  - mergeMeshes utility, [U-90](#)



- mergeOrSplitBaffles utility, [U-90](#)
- mergePatchPairs keyword, [U-135](#)
- mergeTolerance keyword, [U-142](#)
- mesh
  - 1-dimensional, [U-126](#)
  - 1D, [U-126](#)
  - 2-dimensional, [U-126](#)
  - 2D, [U-126](#)
  - axi-symmetric, [U-126](#)
  - basic, [P-31](#)
  - block structured, [U-132](#)
  - decomposition, [U-81](#)
  - description, [U-123](#)
  - finite volume, [P-31](#)
  - generation, [U-132](#), [U-140](#)
  - grading, [U-132](#), [U-136](#)
  - grading, example of, [P-53](#)
  - non-orthogonal, [P-45](#)
  - refinement, [P-62](#)
  - resolution, [U-30](#)
  - specification, [U-123](#)
  - split-hex, [U-140](#)
  - Stereolithography (STL), [U-140](#)
  - surface, [U-140](#)
  - validity constraints, [U-123](#)
- meshes tools, [U-94](#)
- meshQualityControls keyword, [U-142](#)
- meshTools
  - library, [U-95](#)
- message passing interface
  - openMPI, [U-83](#)
- method keyword, [U-83](#)
- metis
  - keyword entry, [U-82](#), [U-83](#)
- metisCoeffs keyword, [U-83](#)
- MGridGen
  - keyword entry, [U-119](#)
- MGridGenGAMGAgglomeration
  - library, [U-96](#)
- mhdFoam solver, [P-69](#), [U-88](#)
- midPoint
  - keyword entry, [U-113](#)
- midPoint keyword, [U-171](#)
- midPointAndFace keyword, [U-171](#)
- min
  - tensor member function, [P-25](#)
- minArea keyword, [U-149](#)
- minDeterminant keyword, [U-149](#)
- minFaceWeight keyword, [U-149](#)
- minFlatness keyword, [U-149](#)
- minMedianAxisAngle keyword, [U-148](#)
- MINMOD differencing, [P-38](#)
- minRefinementCells keyword, [U-143](#)
- minThickness keyword, [U-148](#)
- minTriangleTwist keyword, [U-149](#)
- minTwist keyword, [U-149](#)
- minVol keyword, [U-149](#)
- minVolRatio keyword, [U-149](#)
- mirrorMesh utility, [U-90](#)
- mixed
  - boundary condition, [U-132](#)
- mixedSmagorinsky model, [U-99](#)
- mixtureAdiabaticFlameT utility, [U-93](#)
- mode keyword, [U-145](#)
- model
  - APIfunctions, [U-97](#)
  - BirdCarreau, [U-99](#)
  - CrossPowerLaw, [U-99](#)
  - DeardorffDiffStress, [U-99](#)
  - GuldersEGR LaminarFlameSpeed, [U-97](#)
  - GuldersLaminarFlameSpeed, [U-97](#)
  - HerschelBulkley, [U-99](#)
  - LRDDiffStress, [U-99](#)
  - LRR, [U-98](#)
  - LamBremhorstKE, [U-98](#)
  - LaunderGibsonRSTM, [U-98](#)
  - LaunderSharmaKE, [U-98](#)
  - LienCubicKELowRe, [U-98](#)
  - LienCubicKE, [U-98](#)
  - LienLeschzinerLowRe, [U-98](#)
  - NSRDSfunctions, [U-97](#)
  - Newtonian, [U-99](#)
  - NonlinearKEShah, [U-98](#)
  - PrandtlDelta, [U-98](#)
  - RNGkEpsilon, [U-98](#)
  - RosinRammler, [U-97](#)
  - Smagorinsky2, [U-99](#)
  - Smagorinsky, [U-99](#)
  - SpalartAllmarasDDES, [U-99](#)
  - SpalartAllmarasIDDES, [U-99](#)
  - SpalartAllmaras, [U-98](#), [U-99](#)
  - anisotropicFilter, [U-98](#)
  - basicMultiComponentMixture, [U-96](#), [U-176](#)
  - chemistryModel, [U-97](#)
  - chemistrySolver, [U-97](#)
  - constLaminarFlameSpeed, [U-97](#)
  - constTransport, [U-97](#), [U-176](#)
  - cubeRootVolDelta, [U-98](#)
  - dieselMixture, [U-96](#), [U-176](#)
  - dynMixedSmagorinsky, [U-99](#)
  - dynOneEqEddy, [U-99](#)
  - dynSmagorinsky, [U-99](#)
  - eConstThermo, [U-97](#), [U-175](#)
  - ePsiThermo, [U-96](#), [U-176](#)
  - egrMixture, [U-96](#), [U-176](#)
  - exponential, [U-97](#)
  - general, [U-97](#)
  - hConstThermo, [U-97](#), [U-175](#)

hPolynomialThermo, [U-97](#), [U-175](#)

hPsiMixtureThermo, [U-96](#), [U-176](#)

hPsiThermo, [U-96](#), [U-176](#)

hRhoMixtureThermo, [U-96](#), [U-176](#)

hRhoThermo, [U-96](#), [U-176](#)

hhuMixtureThermo, [U-96](#) 0 0 10 0 0 cm BT /R251 10.9091 Tf 1 0 0 1 211.806 759.658 Tm (,)-0.248413TJ

- applications, [U-69](#)
    - file format, [U-102](#)
    - libraries, [U-69](#)
  - OpenFOAM
    - library, [U-94](#)
  - OpenFOAM file syntax
    - //, [U-102](#)
  - openMPI
    - message passing interface, [U-83](#)
    - MPI, [U-83](#)
  - operator
    - scalar, [P-28](#)
    - vector, [P-27](#)
  - Options window, [U-163](#)
  - options* file, [U-73](#)
  - order keyword, [U-83](#)
  - Orientation Axes button, [U-26](#), [U-163](#)
  - OSspecific
    - library, [U-96](#)
  - outer product, *see* tensor, outer product
  - outlet
    - boundary condition, [P-69](#)
  - outletInlet
    - boundary condition, [U-133](#)
  - outside
    - keyword entry, [U-145](#)
  - owner*
    - dictionary, [U-125](#)
- P**
- p field, [U-24](#)
  - P1
    - library, [U-96](#)
  - paraFoam, [U-25](#), [U-159](#)
  - parallel
    - running, [U-81](#)
  - partialSlip
    - boundary condition, [U-133](#)
  - particleTracks utility, [U-92](#)
  - patch
    - boundary condition, [U-131](#)
  - patch
    - keyword entry, [U-130](#), [U-172](#)
  - patchAverage utility, [U-92](#)
  - patches keyword, [U-135](#), [U-137](#)
  - patchIntegrate utility, [U-92](#)
  - patchMap keyword, [U-156](#)
  - patchSummary utility, [U-94](#)
  - PBiCG
    - keyword entry, [U-118](#)
  - PCG
    - keyword entry, [U-118](#)
  - pdf
    - library, [U-97](#)
  - pdfPlot utility, [U-93](#)
  - pdRefCell keyword, [U-121](#)
  - pdRefValue keyword, [U-121](#)
  - PDRFoam solver, [U-87](#)
  - Pe utility, [U-92](#)
  - perfectGas model, [U-97](#), [U-175](#)
  - permutation symbol, [P-19](#)
  - pimpleDyMFoam solver, [U-86](#)
  - pimpleFoam solver, [U-86](#)
  - Pipeline Browser window, [U-25](#), [U-160](#)
  - PISO*
    - dictionary, [U-25](#)
  - pisoFoam solver, [U-19](#), [U-86](#)
  - Plot Over Line
    - menu entry, [U-35](#)
  - Plot Type menu, [U-35](#)
  - plot3dToFoam utility, [U-89](#)
  - pointField class, [P-31](#)
  - pointField<Type> template class, [P-33](#)
  - points*
    - dictionary, [U-125](#), [U-132](#)
  - polyBoundaryMesh class, [P-31](#)
  - polyDualMesh utility, [U-90](#)
  - polyLine
    - keyword entry, [U-136](#)
  - polyMesh* directory, [U-102](#), [U-125](#)
  - polyMesh class, [P-31](#), [U-123](#), [U-125](#)
  - polynomialTransport model, [U-97](#), [U-176](#)
  - polyPatch class, [P-31](#)
  - polyPatchList class, [P-31](#)
  - polySpline
    - keyword entry, [U-136](#)
  - porousExplicitSourceReactingParcelFoam solver, [U-88](#)
  - post-processing, [U-159](#)
    - post-processing
      - paraFoam, [U-159](#)
  - postCalc
    - library, [U-95](#)
  - postChannel utility, [U-93](#)
  - potential
    - library, [U-95](#)
  - potentialFoam solver, [P-46](#), [U-85](#)
  - pow
    - tensor member function, [P-25](#)
  - powerLaw model, [U-99](#)
  - pPrime2 utility, [U-92](#)
  - PrandtlDelta model, [U-98](#)
  - preconditioner keyword, [U-118](#), [U-119](#)
  - pRefCell keyword, [U-25](#), [U-121](#)
  - pRefValue keyword, [U-25](#), [U-121](#)
  - pressure keyword, [U-50](#)
  - pressure waves
    - in liquids, [P-62](#)

pressureDirectedInletVelocity  
     boundary condition, [U-133](#)  
 pressureInletVelocity  
     boundary condition, [U-133](#)  
 pressureOutlet  
     boundary condition, [P-63](#)  
 pressureTransmissive  
     boundary condition, [U-133](#)  
 primitive  
     library, [P-23](#)  
 primitives tools, [U-94](#)  
 printCoeffs keyword, [U-42](#)  
 processorWeights keyword, [U-82](#)  
 probeLocations utility, [U-92](#)  
 process  
     background, [U-26](#), [U-81](#)  
     foreground, [U-26](#)  
 processor  
     boundary condition, [U-131](#)  
 processor  
     keyword entry, [U-130](#)  
*processorN* directory, [U-82](#)  
 processorWeights keyword, [U-83](#)  
 Properties window panel, [U-28](#), [U-160](#)  
 ptot utility, [U-93](#)  
 pureMixture model, [U-96](#), [U-176](#)  
 purgeWrite keyword, [U-109](#)  
 PV3FoamReader  
     library, [U-159](#)  
 PV3FoamReader utility, [U-91](#)  
 PVFoamReader  
     library, [U-159](#)  
 PVFoamReader utility, [U-91](#)

## Q

Q utility, [U-92](#)  
 QUICK  
     keyword entry, [U-113](#), [U-116](#)  
 qZeta model, [U-98](#)

## R

R utility, [U-92](#)  
 radiation  
     library, [U-96](#)  
 randomProcesses  
     library, [U-96](#)  
 RASModel keyword, [U-179](#)  
 RASmodel  
     keyword entry, [U-42](#), [U-178](#)  
 raw  
     keyword entry, [U-109](#), [U-170](#)  
 reactingFoam solver, [U-87](#)  
 reactingMixture model, [U-96](#), [U-176](#)  
 reactingParcelFoam solver, [U-88](#)

reactionThermophysicalModels  
     library, [U-96](#)  
 realizableKE model, [U-98](#)  
 reconstructPar utility, [U-85](#), [U-93](#)  
 reconstructParMesh utility, [U-93](#)  
 redistributeMeshPar utility, [U-93](#)  
 refGradient keyword, [U-132](#)  
 refineHexMesh utility, [U-91](#)  
 refinementRegions keyword, [U-145](#)  
 refinementLevel utility, [U-91](#)  
 refinementRegions keyword, [U-143](#), [U-146](#)  
 refinementSurfaces keyword, [U-143](#)  
 refineMesh utility, [U-90](#)  
 refineWallLayer utility, [U-91](#)  
 Region Status window panel, [U-25](#)  
 regions keyword, [U-59](#)  
 relative tolerance, [U-118](#)  
 relativeSizes keyword, [U-148](#)  
 relaxed keyword, [U-149](#)  
 relTol keyword, [U-53](#), [U-118](#)  
 removeFaces utility, [U-91](#)  
 Render View window, [U-164](#)  
 Render View window panel, [U-163](#)  
 Render View Options window, [U-163](#)  
 renumberMesh utility, [U-90](#)  
 Rescale to Data Range button, [U-28](#)  
 Reset button, [U-160](#)  
 resolveFeatureAngle keyword, [U-143](#), [U-144](#)  
 restart, [U-39](#)  
 Reynolds number, [U-19](#), [U-23](#)  
 rhoCentralFoam solver, [U-86](#)  
 rhoPisoFoam solver, [U-86](#)  
 rhoPimpleFoam solver, [U-86](#)  
 rhoPorousSimpleFoam solver, [U-86](#)  
 rhoPsonicFoam solver, [U-86](#)  
 rhoReactingFoam solver, [U-87](#)  
 rhoSimpleFoam solver, [U-86](#)  
 rhoSonicFoam solver, [U-86](#)  
 rmdepall script/alias, [U-76](#)  
 RNGkEpsilon model, [U-98](#)  
 roots keyword, [U-83](#), [U-84](#)  
 RosinRammler model, [U-97](#)  
 rotateMesh utility, [U-90](#)  
 run  
     parallel, [U-81](#)  
*run* directory, [U-101](#)  
 runTime  
     keyword entry, [U-33](#), [U-108](#)  
 runTimeModifiable keyword, [U-109](#)

## S

sammToFoam utility, [U-90](#)  
 sample utility, [U-93](#), [U-169](#)  
 sampling

- library, [U-95](#)
- Save Animation
  - menu entry, [U-165](#)
- Save Screenshot
  - menu entry, [U-165](#)
- scalar, [P-16](#)
  - operator, [P-28](#)
- scalar class, [P-23](#)
- scalarField class, [P-29](#)
- scalarTransportFoam solver, [U-85](#)
- scale
  - tensor member function, [P-25](#)
- scalePoints utility, [U-153](#)
- scaleSimilarity model, [U-99](#)
- scientific
  - keyword entry, [U-109](#)
- scotch
  - keyword entry, [U-82](#), [U-83](#)
- scotchCoeffs keyword, [U-83](#)
- script/alias
  - foamCorrectVrt, [U-154](#)
  - foamJob, [U-173](#)
  - foamLog, [U-173](#)
  - make, [U-71](#)
  - rmdepall, [U-76](#)
  - wclean, [U-75](#)
  - wmake, [U-71](#)
- second time derivative, [P-37](#)
- Seed window, [U-164](#)
- selectCells utility, [U-91](#)
- Set Solid Color button, [U-162](#)
- setFields utility, [U-58](#), [U-59](#), [U-89](#)
- setFormat keyword, [U-170](#)
- sets keyword, [U-170](#)
- setSet utility, [U-90](#)
- setsToZones utility, [U-90](#)
- Settings
  - menu entry, [U-163](#)
- settlingFoam solver, [U-87](#)
- SFCD
  - keyword entry, [U-113](#), [U-116](#)
- shallowWaterFoam solver, [U-86](#)
- shape, [U-136](#)
- Show Color Legend
  - menu entry, [U-28](#)
- SI units, [U-105](#)
- simple
  - keyword entry, [U-82](#), [U-83](#)
- simpleFilter model, [U-98](#)
- simpleFoam solver, [P-54](#), [U-86](#)
- simpleGrading keyword, [U-136](#)
- simpleSpline
  - keyword entry, [U-136](#)
- simulationType keyword, [U-42](#), [U-60](#), [U-178](#)
- skew
  - tensor member function, [P-25](#)
- skewLinear
  - keyword entry, [U-113](#), [U-116](#)
- slice class, [P-31](#)
- slip
  - boundary condition, [U-133](#)
- Smagorinsky model, [U-99](#)
- Smagorinsky2 model, [U-99](#)
- smapToFoam utility, [U-91](#)
- smoothDelta model, [U-98](#)
- smoother keyword, [U-120](#)
- smoothSolver
  - keyword entry, [U-118](#)
- snap keyword, [U-142](#)
- snapControls keyword, [U-142](#)
- snappyHexMesh utility
  - background mesh, [U-142](#)
  - cell removal, [U-144](#)
  - cell splitting, [U-143](#)
  - mesh layers, [U-146](#)
  - meshing process, [U-141](#)
  - snapping to surfaces, [U-146](#)
- snappyHexMesh utility, [U-89](#), [U-140](#)
- snappyHexMeshDict* file, [U-141](#)
- snGrad
  - fvf member function, [P-37](#)
- snGradCorrection
  - fvf member function, [P-37](#)
- snGradSchemes keyword, [U-111](#)
- Solid Color
  - menu entry, [U-162](#)
- solidDisplacementFoam solver, [U-88](#)
- solidDisplacementFoam solver, [U-51](#)
- solidEquilibriumDisplacementFoam solver, [U-88](#)
- solidMixture
  - library, [U-98](#)
- solidParticle
  - library, [U-96](#)
- solids
  - library, [U-98](#)
- solver
  - PDRFoam, [U-87](#)
  - XiFoam, [U-87](#)
  - blockMesh, [P-47](#)
  - boundaryFoam, [U-85](#)
  - bubbleFoam

chtMultiRegionFoam,

- surfaceNormalFixedValue
    - boundary condition, [U-133](#)
  - surfaces keyword, [U-170](#)
  - surfMesh
    - library, [U-95](#)
  - SuSp
    - fvm member function, [P-37](#)
  - sutherlandTransport model, [U-97](#), [U-176](#)
  - symm
    - tensor member function, [P-25](#)
  - symmetryPlane
    - boundary condition, [P-63](#), [U-131](#)
  - symmetryPlane
    - keyword entry, [U-130](#)
  - symmTensorField class, [P-29](#)
  - symmTensorThirdField class, [P-29](#)
  - system directory, [P-49](#), [U-102](#)
  - systemCall
    - library, [U-95](#)
- T**
- T()
    - tensor member function, [P-25](#)
  - template class
    - GeometricBoundaryField, [P-32](#)
    - fvMatrix, [P-33](#)
    - dimensioned<Type>, [P-25](#)
    - FieldField<Type>, [P-32](#)
    - Field<Type>, [P-29](#)
    - geometricField<Type>, [P-32](#)
    - List<Type>, [P-29](#)
    - pointField<Type>, [P-33](#)
    - surfaceField<Type>, [P-33](#)
    - volField<Type>, [P-33](#)
  - temporal discretisation, [P-42](#)
    - Crank Nicholson, [P-42](#)
    - Euler implicit, [P-42](#)
    - explicit, [P-42](#)
    - in OpenFOAM, [P-43](#)
  - tensor, [P-15](#)
    - addition, [P-17](#)
    - algebraic operations, [P-17](#)
    - algebraic operations in OpenFOAM, [P-23](#)
    - antisymmetric, *see* tensor, skew
    - calculus, [P-27](#)
    - classes in OpenFOAM, [P-23](#)
    - cofactors, [P-22](#)
    - component average, [P-20](#)
    - component maximum, [P-20](#)
    - component minimum, [P-20](#)
    - determinant, [P-22](#)
    - deviatoric, [P-21](#)
    - diagonal, [P-21](#)
    - dimension, [P-16](#)
    - double inner product, [P-19](#)
    - geometric transformation, [P-20](#)
    - Hodge dual, [P-22](#)
    - hydrostatic, [P-21](#)
    - identities, [P-21](#)
    - identity, [P-20](#)
    - inner product, [P-18](#)
    - inverse, [P-22](#)
    - magnitude, [P-20](#)
    - magnitude squared, [P-20](#)
    - mathematics, [P-15](#)
    - notation, [P-17](#)
    - n*th power, [P-20](#)
    - outer product, [P-19](#)
    - rank, [P-16](#)
    - rank 3, [P-16](#)
    - scalar division, [P-18](#)
    - scalar multiplication, [P-17](#)
    - scale function, [P-20](#)
    - second rank, [P-16](#)
    - skew, [P-21](#)
    - square of, [P-20](#)
    - subtraction, [P-17](#)
    - symmetric, [P-21](#)
    - symmetric rank 2, [P-16](#)
    - symmetric rank 3, [P-16](#)
    - trace, [P-21](#)
    - transformation, [P-20](#)
    - transpose, [P-16](#), [P-21](#)
    - triple inner product, [P-19](#)
    - vector cross product, [P-19](#)
  - tensor class, [P-23](#)
  - tensor member function
    - [\\*](#), [P-25](#)
    - [+](#), [P-25](#)
    - [-](#), [P-25](#)
    - [/](#), [P-25](#)
    - [&](#), [P-25](#)
    - [&&](#), [P-25](#)
    - [^](#), [P-25](#)
    - cmptAv, [P-25](#)
    - cofactors, [P-25](#)
    - det, [P-25](#)
    - dev, [P-25](#)
    - diag, [P-25](#)
    - I, [P-25](#)
    - inv, [P-25](#)
    - mag, [P-25](#)
    - magSqr, [P-25](#)
    - max, [P-25](#)
    - min, [P-25](#)
    - pow, [P-25](#)
    - scale, [P-25](#)
    - skew, [P-25](#)

sqr, [P-25](#)  
 symm, [P-25](#)  
 T(), [P-25](#)  
 tr, [P-25](#)  
 transform, [P-25](#)  
 tensorField class, [P-29](#)  
 tensorThirdField class, [P-29](#)  
 tetgenToFoam utility, [U-90](#)  
 text box  
   Opacity, [U-163](#)  
*thermalProperties*  
   dictionary, [U-51](#)  
 thermophysical  
   library, [U-175](#)  
 thermophysicalFunctions  
   library, [U-97](#)  
*thermophysicalProperties*  
   dictionary, [U-175](#)  
 thermoType keyword, [U-175](#)  
 time  
   control, [U-108](#)  
 time derivative, [P-37](#)  
   first, [P-39](#)

U(8)0,0492351(7)0.0492351TJ ET 0 0 0 1 K 0 0 0 1 k q 10 0 0 10 0 0 cm BT /R1356 10.9091 Tf 1 0 0 13010.0122



uniform keyword, [U-171](#)

units

base, [U-105](#)

of measurement, [P-25](#), [U-105](#)

S.I. base, [P-25](#)

SI, [U-105](#)

Système International, [U-105](#)

United States Customary System, [U-105](#)

USCS, [U-105](#)

Update GUI button, [U-28](#), [U-161](#)

uprime utility, [U-92](#)

upwind

keyword entry, [U-113](#), [U-116](#)

upwind differencing, [P-38](#), [U-61](#)

USCS units, [U-105](#)

Us3 247294TJ 49231TJT Q 1 K 1 k q 1 1 cm BT R21 1 9 91 Tf 1 1 7 9 1 Tm u 329

pdfPlot, [U-93](#)  
 plot3dToFoam, [U-89](#)  
 polyDualMesh, [U-90](#)  
 postChannel, [U-93](#)  
 probeLocations, [U-92](#)  
 ptot, [U-93](#)  
 reconstructParMesh, [U-93](#)  
 reconstructPar, [U-85](#), [U-93](#)  
 redistributeMeshPar, [U-93](#)  
 refineHexMesh, [U-91](#)  
 refineMesh, [U-90](#)  
 refineWallLayer, [U-91](#)  
 refinementLevel, [U-91](#)  
 removeFaces, [U-91](#)  
 renumberMesh, [U-90](#)  
 rotateMesh, [U-90](#)  
 sammToFoam, [U-90](#)  
 sample, [U-93](#), [U-169](#)  
 scalePoints, [U-153](#)  
 selectCells, [U-91](#)  
 setFields, [U-58](#), [U-59](#), [U-89](#)  
 setSet, [U-90](#)  
 setsToZones, [U-90](#)  
 smapToFoam, [U-91](#)  
 snappyHexMesh, [U-89](#), [U-140](#)  
 splitCells, [U-91](#)  
 splitMeshRegions, [U-90](#)  
 splitMesh, [U-90](#)  
 star4ToFoam, [U-90](#)  
 starToFoam, [U-90](#), [U-149](#)  
 stitchMesh, [U-90](#)  
 streamFunction, [U-92](#)  
 stressComponents, [U-92](#)  
 subsetMesh, [U-91](#)  
 tetgenToFoam, [U-90](#)  
 transformPoints, [U-91](#)  
 uprime, [U-92](#)  
 vorticity, [U-92](#)  
 wallGradU, [U-92](#)  
 wallHeatFlux, [U-92](#)  
 wallShearStress, [U-92](#)  
 wdot, [U-93](#)  
 writeCellCentres, [U-93](#)  
 writeMeshObj, [U-90](#)  
 yPlusLES, [U-92](#)  
 yPlusRAS, [U-92](#)  
 zipUpMesh, [U-91](#)  
 cellSet, [U-90](#)  
 faceSet, [U-90](#)  
 pointSet, [U-90](#)  
 utilityFunctionObjects  
   library, [U-95](#)

## V

value keyword, [U-23](#), [U-132](#)  
 valueFraction keyword, [U-132](#)  
 van Leer differencing, [P-38](#)  
 vanLeer  
   keyword entry, [U-113](#)  
 VCR Controls menu, [U-28](#), [U-161](#)  
 vector, [P-16](#)  
   operator, [P-27](#)  
   unit, [P-20](#)  
 vector class, [P-23](#), [U-105](#)  
 vector product, *see* tensor, vector cross product  
 vectorField class, [P-29](#)  
 version keyword, [U-103](#)  
 vertices keyword, [U-22](#), [U-135](#)  
 veryInhomogeneousMixture model, [U-96](#), [U-176](#)  
 View menu, [U-163](#)  
 View Settings  
   menu entry, [U-26](#), [U-163](#)  
 View Settings...  
   menu entry, [U-25](#)  
 viscosity  
   kinematic, [U-23](#), [U-42](#)  
 volField<Type> template class, [P-33](#)  
 vorticity utility, [U-92](#)  
 vtk  
   keyword entry, [U-170](#)  
 vtkFoam  
   library, [U-159](#)  
 vtkPV3Foam  
   library, [U-159](#)

## W

wall  
   boundary condition, [P-63](#), [P-69](#), [U-58](#),  
   [U-131](#)  
 wall  
   keyword entry, [U-130](#)  
 wallBuoyantPressure  
   boundary condition, [U-133](#)  
 wallGradU utility, [U-92](#)  
 wallHeatFlux utility, [U-92](#)  
 Wallis  
   library, [U-97](#)  
 wallShearStress utility, [U-92](#)  
 wclean script/alias, [U-75](#)  
 wdot utility, [U-93](#)  
 wedge  
   boundary condition, [U-126](#), [U-131](#), [U-139](#)  
 wedge  
   keyword entry, [U-130](#)  
 window  
   *Chart Options*, [U-36](#)  
   *Color Legend*, [U-30](#)

- Options*, [U-163](#)
  - Pipeline Browser*, [U-25](#), [U-160](#)
  - Render View Options*, [U-163](#)
  - Render View*, [U-164](#)
  - Seed*, [U-164](#)
  - window panel
    - Annotation*, [U-26](#), [U-163](#)
    - Color Legend*, [U-162](#)
    - Color Scale*, [U-162](#)
    - Display*, [U-25](#), [U-28](#), [U-160](#), [U-161](#)
    - General*, [U-163](#)
    - Information*, [U-160](#)
    - Lights*, [U-163](#)
    - Properties*, [U-28](#), [U-160](#)
    - Region Status*, [U-25](#)
    - Render View*, [U-163](#)
    - Style*, [U-25](#), [U-162](#)
  - Wireframe
    - menu entry, [U-162](#)
  - WM\_ARCH
    - environment variable, [U-76](#)
  - WM\_COMPILE\_OPTION
    - environment variable, [U-76](#)
  - WM\_COMPILER
    - environment variable, [U-76](#)
  - WM\_COMPILER\_BIN
    - environment variable, [U-76](#)
  - WM\_COMPILER\_DIR
    - environment variable, [U-76](#)
  - WM\_COMPILER\_LIB
    - environment variable, [U-76](#)
  - WM\_DIR
    - environment variable, [U-76](#)
  - WM\_JAVAC\_OPTION
    - environment variable, [U-76](#)
  - WM\_LINK\_LANGUAGE
    - environment variable, [U-76](#)
  - WM\_MPLIB
    - environment variable, [U-76](#)
  - WM\_OPTIONS
    - environment variable, [U-76](#)
  - WM\_PROJECT
    - environment variable, [U-76](#)
  - WM\_PROJECT\_DIR
    - environment variable, [U-76](#)
  - WM\_PROJECT\_INST\_DIR
    - environment variable, [U-76](#)
  - WM\_PROJECT\_LANGUAGE
    - environment variable, [U-76](#)
  - WM\_PROJECT\_USER\_DIR
    - environment variable, [U-76](#)
  - WM\_PROJECT\_VERSION
    - environment variable, [U-76](#)
  - WM\_SHELL
    - environment variable, [U-76](#)
  - wmake
    - platforms, [U-73](#)
  - wmake script/alias, [U-71](#)
  - word class, [P-25](#), [P-31](#)
  - writeCellCentres utility, [U-93](#)
  - writeCompression keyword, [U-109](#)
  - writeControl
    - keyword entry, [U-108](#)
  - writeControl keyword, [U-24](#), [U-60](#), [U-108](#)
  - writeFormat keyword, [U-55](#), [U-109](#)
  - writeInterval keyword, [U-24](#), [U-33](#), [U-109](#)
  - writeMeshObj utility, [U-90](#)
  - writeNow
    - keyword entry, [U-108](#)
  - writePrecision keyword, [U-109](#)
- ## X
- x
    - keyword entry, [U-171](#)
  - XiFoam solver, [U-87](#)
  - xmgr
    - keyword entry, [U-109](#), [U-170](#)
  - xyz
    - keyword entry, [U-171](#)
- ## Y
- y
    - keyword entry, [U-171](#)
  - yPlusLES utility, [U-92](#)
  - yPlusRAS utility, [U-92](#)
- ## Z
- z
    - keyword entry, [U-171](#)
  - zeroGradient
    - boundary condition, [U-132](#)
  - zipUpMesh utility, [U-91](#)